

Spectrum Analyzer

GSP-9330

USER MANUAL



ISO-9001 CERTIFIED MANUFACTURER

GW INSTEK

This manual contains proprietary information, which is protected by copyright. All rights are reserved. No part of this manual may be photocopied, reproduced or translated to another language without prior written consent of Good Will company.

The information in this manual was correct at the time of printing. However, Good Will continues to improve products and reserves the rights to change specification, equipment, and maintenance procedures at any time without notice.

Good Will Instrument Co., Ltd.
No. 7-1, Jhongsing Rd., Tucheng Dist., New Taipei City 236, Taiwan.

Table of Contents

SAFETY INSTRUCTIONS	3
GETTING STARTED.....	8
GSP-9330 Introduction	9
Accessories.....	12
Appearance.....	14
First Use Instructions	26
BASIC OPERATION	38
Frequency Settings.....	41
Span Settings.....	45
Amplitude Settings	48
Autoset	62
Bandwidth/Average Settings	64
Sweep	70
Trace.....	77
Trigger	85
Marker	90
Display.....	106
System Settings	115
Preset	119
ADVANCED OPERATION.....	121
Measurement.....	123
EMC Pre-Compliance Testing	201
Limit Line Testing	222
Sequence	229
Tracking Generator	234
Power Meter	239
Demo Kit	244

FILE	249
File Overview	249
REMOTE CONTROL.....	266
Interface Configuration	267
FAQ.....	281
APPENDIX.....	282
Replace the Clock Battery	282
Glossary of Acronyms	283
GSP-9330 Default Settings	285
Menu Tree.....	287
GSP-9330 Specifications	332
GSP-9330 Dimensions	340
Declaration of Conformity.....	341
INDEX.....	342

S SAFETY INSTRUCTIONS

This chapter contains important safety instructions that you must follow during operation and storage. Read the following before any operation to ensure your safety and to keep the instrument in the best possible condition.

Safety Symbols

These safety symbols may appear in this manual or on the instrument.



WARNING

Warning: Identifies conditions or practices that could result in injury or loss of life.



CAUTION

Caution: Identifies conditions or practices that could result in damage to the instrument or to other properties.



DANGER High Voltage



Attention Refer to the Manual



Earth (ground) Terminal



Frame or Chassis Terminal



Do not dispose electronic equipment as unsorted municipal waste. Please use a separate collection facility or contact the supplier from which this instrument was purchased.

Safety Guidelines

General Guideline





CAUTION

- Do not place any heavy object on the instrument.
- Avoid severe impact or rough handling that leads to damaging the instrument.
- Do not discharge static electricity to the instrument.
- Use only mating connectors, not bare wires, for the terminals.
- Ensure signals to the RF input do not exceed +30dBm.
- Ensure reverse power to the TG output terminal does not exceed +30dBm.
- Do not supply any input signals to the TG output.
- Do not block the cooling fan opening.
- Do not disassemble the instrument unless you are qualified.

(Measurement categories) EN 61010-1:2010 specifies the measurement categories and their requirements as follows. The instrument falls under category II.

- Measurement category IV is for measurement performed at the source of low-voltage installation.
- Measurement category III is for measurement performed in the building installation.
- Measurement category II is for measurement performed on the circuits directly connected to the low voltage installation.
- Measurement category I is for measurements performed on circuits not directly connected to Mains.

- Power Supply
- AC Input voltage range: 100V~240V
 - Frequency: 50/60Hz
 - To avoid electrical shock connect the protective grounding conductor of the AC power cord to an earth ground.
-  WARNING
-

- Battery
- Rating: 10.8V, 6 cell Li-ion battery
 - Turn off the power and remove the power cord before installing or removing the battery.
-  CAUTION
-

- Cleaning
- Disconnect the power cord before cleaning.
 - Use a soft cloth dampened in a solution of mild detergent and water. Do not spray any liquid.
 - Do not use chemicals containing harsh material such as benzene, toluene, xylene, and acetone.
-

- Operation Environment
- Location: Indoor, no direct sunlight, dust free, almost non-conductive pollution (Note below)
 - Temperature: 5°C to 45°C
 - Humidity: <90%
- (Pollution Degree) EN 61010-1:2010 specifies the pollution degrees and their requirements as follows. The instrument falls under degree 2.
- Pollution refers to “addition of foreign matter, solid, liquid, or gaseous (ionized gases), that may produce a reduction of dielectric strength or surface resistivity”.
 - Pollution degree 1: No pollution or only dry, non-conductive pollution occurs. The pollution has no influence.
 - Pollution degree 2: Normally only non-conductive pollution occurs. Occasionally, however, a temporary conductivity caused by condensation must be expected.
 - Pollution degree 3: Conductive pollution occurs, or dry, non-conductive pollution occurs which becomes conductive due to condensation which is expected. In such conditions, equipment is normally protected against exposure to direct sunlight, precipitation, and full wind pressure, but neither temperature nor humidity is controlled.
-

Storage environment

- Location: Indoor
 - Temperature: -20°C to 70°C
 - Humidity: <90%
-

Disposal

Do not dispose this instrument as unsorted municipal waste. Please use a separate collection facility or contact the supplier from which this instrument was purchased. Please make sure discarded electrical waste is properly recycled to reduce environmental impact.

Power cord for the United Kingdom

When using the instrument in the United Kingdom, make sure the power cord meets the following safety instructions.

NOTE: This lead/appliance must only be wired by competent persons

 **WARNING: THIS APPLIANCE MUST BE EARTHED**

IMPORTANT: The wires in this lead are coloured in accordance with the following code:

Green/ Yellow:	Earth
Blue:	Neutral
Brown:	Live (Phase)



As the colours of the wires in main leads may not correspond with the coloured marking identified in your plug/appliance, proceed as follows:

The wire which is coloured Green & Yellow must be connected to the Earth terminal marked with either the letter E, the earth symbol  or coloured Green/Green & Yellow.

The wire which is coloured Blue must be connected to the terminal which is marked with the letter N or coloured Blue or Black.

The wire which is coloured Brown must be connected to the terminal marked with the letter L or P or coloured Brown or Red.

If in doubt, consult the instructions provided with the equipment or contact the supplier.

This cable/appliance should be protected by a suitably rated and approved HBC mains fuse: refer to the rating information on the equipment and/or user instructions for details. As a guide, a cable of 0.75mm² should be protected by a 3A or 5A fuse. Larger conductors would normally require 13A types, depending on the connection method used.

Any exposed wiring from a cable, plug or connection that is engaged in a live socket is extremely hazardous. If a cable or plug is deemed hazardous, turn off the mains power and remove the cable, any fuses and fuse assemblies. All hazardous wiring must be immediately destroyed and replaced in accordance to the above standard.

G ETTING STARTED

This chapter provides a brief overview of the GSP-9330, the package contents, instructions for first time use and an introduction to the front panel, rear panel and GUI.



GSP-9330 Introduction	9
Main Features	9
Accessories	12
Appearance	14
GSP-9330 Front Panel	14
Rear Panel	19
Display	21
Status Icon Overview	24
First Use Instructions	26
Tilting the Stand	26
Inserting the Battery Pack	27
Power UP	28
Power Down	29
Setting the Date, Time and Wake-Up Clock	30
Firmware Update	32
Restoring Default Settings	33
Conventions	34

GSP-9330 Introduction

The GSP-9330 builds on the strong feature set of the GSP-9300 and significantly increases performance in almost every aspect; making this the most comprehensive and feature-rich spectrum analyzer GW Instek has released.

Like the GSP-9300, the GSP-9330 features a split window display to view data in spectrum, topographic or spectrographic views. There are also a number of additional test functions such as 2FSK, P1DB and new dedicated EMC pretest functions for EMI and EMS testing. Lastly, the GSP-9330 significantly reduces the sweep time.

Main Features

Performance	<ul style="list-style-type: none">• 9kHz~3.25GHz bandwidth• 1Hz resolution• Nominal RBW accuracy of $\pm 5\%$ <1MHz, $\pm 8\%$ =1MHz• Video bandwidth 1Hz~1MHz (1-3-10 steps)• Amplitude measurement range: DANL~30dBm (frequency dependent)• Input attenuation: 0 ~ 50dB, 1dB steps• Phase noise: < -88dBc/Hz@1GHz, 10kHz, typical
Features	<ul style="list-style-type: none">• 1-3-10 step increments for RBW bandwidth• Three display modes: Spectrum, Topographic and Spectrographic• Split window display• Built-in EMI filter• Auto Wake-up• Built-in preamplifier• Gate sweep• Marker Frequency counter

- Two operating modes: Spectrum and Power Meter mode
- EMI Pretest functions
- SEM measurement
- ACPR measurement
- OCBW measurement
- 2FSK measurement
- Phase jitter measurement
- Harmonics measurement
- P1dB measurement
- Channel power measurement
- Demodulation analyzer
- Diverse marker functions and features with Peak Table
- Sequence function to automatically perform pre-programmed sequential operations
- EMI quasi-peak and average detector
- Optional battery operation

Interface

- 8.4 color LCD (800×600)
- On-screen menu icons
- DVI-I video output
- RS-232 with RTS/CTS hardware flow control
- USB 2.0 with support for USB TMC
- LAN TCP/IP with LXI support
- Optional GPIB/IEEE488 interface
- Optional 3G USB adapter for WLAN
- Optional power meter adapter
- IF output @ 886MHz
- Headphone output
- REF (reference clock) input/output BNC ports

- Alarm/Open collector output BNC port
- Trigger/Gate input BNC ports
- RF N-type input port
- Tracking generator output
- DC +7V/500mA output SMB port

Accessories

Standard Accessories	Part number	Description
	Region dependant	Power cord
	N/A	User manual CD: Includes: User manual, Programming manual, SpectrumShot quick start guide, SpectrumShot software, IVI driver
	N/A	Quick start guide
	N/A	Certificate of calibration
Options	Option number	Description
	Opt1.	Tracking generator
	Opt2.	Battery (11.1V/5200mAH Li-ion battery)
	Opt3.	GPIB interface (IEEE 488 bus)
Optional Accessories	Part number	Description
	ADB-002	DC BLOCK BNC 50R 10MHz-2.2GHz
	ADB-006	DC BLOCK N TYPE 50R 10MHz-6GHz
	ADB-008	DC BLOCK SMA 50R 0.1MHz-8GHz
	GSC-009	Soft Carrying Case
	GRA-415	6U Rack mount kit

Software Downloads

PC Software for Windows System (SpectrumShot quick start guide, SpectrumShot software)

IVI Driver Supports LabView & LabWindows/CVI Programming



Android System (“GSP-9330 Remote Control”, available on Google play.)

Appearance

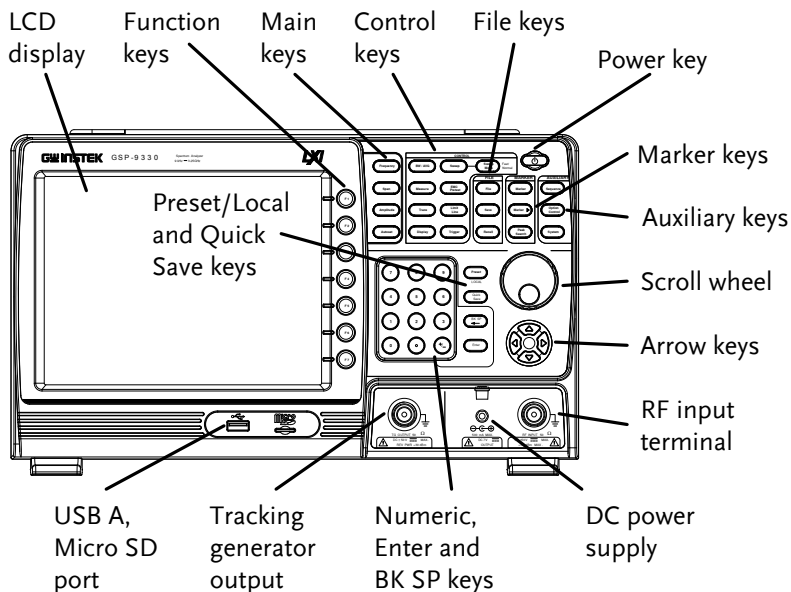
GSP-9330 Front Panel





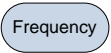

LCD display 800×600 color LCD display. The display shows the soft keys for the current function, frequency, amplitude and marker information.

Function keys  ~  The F1 to F7 function keys directly correspond to the soft keys on the right-hand side of display.

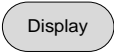
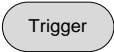
Main keys  Sets the center frequency, start frequency, stop frequency, center frequency step and frequency offset values.

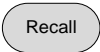
	Span	Sets the span, with options for full span, zero span and last span.
	Amplitude	Sets the amplitude reference level, attenuation, pre-amplifier controls, scale and other options for attenuation and scale.
	Autoset	Automatically searches the peak signal with maximum amplitude and displays it with appropriate horizontal and vertical scales.
Control keys	BW/Avg	Sets the resolution bandwidth, video bandwidth, average type and turns the EMI filter on/off.
	Sweep	Sets the sweep time and gate time.
	Sweep Mode	Toggles the Sweep Control between <i>Fast</i> and <i>Normal</i> mode.
	Measure	Accesses measurement options such as ACPR, OCBW, demodulation measurements, SEM, TOI, 2FSK, phase jitter and other advanced measurements.
	EMC Pretest	Dedicated EMI testing and setup menu.
	Trace	Sets traces and trace related functions.
	Limit Line	Sets and tests Pass/Fail limit lines.

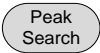
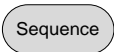
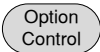
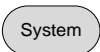
		The Display key configures the windowing mode and basic display properties.
		Sets the triggering modes.
<hr/>		
File		File utilities options
		Save the trace, state etc., and save options.
		Recall the trace, state etc., and recall options.
<hr/>		
Marker		Turns the Markers on/off and configures the markers.
		The <i>Marker</i> ► key positions the markers on the trace.
		Finds each maximum and minimum peak. Used with the Marker function.
<hr/>		
Auxiliary		Access, set and edit program sequences.
		The <i>Option Control</i> key allows you to setup optional accessories such as the Tracking Generator, Power Meter or Demo Kit.
		The System key shows system information, settings and other system related functions.
<hr/>		

Preset / Local key



The *Preset* key will restore the spectrum analyzer to the Factory or User Preset settings.

The Preset key will also return the instrument back to local control after it has been in remote control mode.



The Quick Save utility allows you to save either the state, trace, display screen, limit line, correction or sequence with only a single press.

Power key

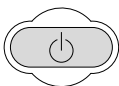

Turns the instrument on/off. On = yellow, off = blue.

Scroll wheel

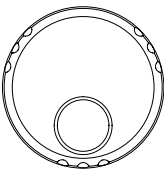

Edit values, select listed items.

Arrow keys

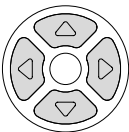

Increment/decrement values (in steps), select listed items.

RF input terminal

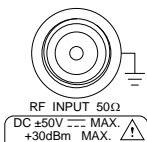

RF input port. Accepts RF inputs.

- Maximum input: +30dBm
- Input impedance: 50Ω
- Maximum DC voltage: ±50V
- N-type: female

DC power supply

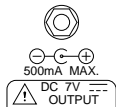

SMB port supplies power for optional accessories.

- DC +7V
- 500mA Max.

Numeric keypad

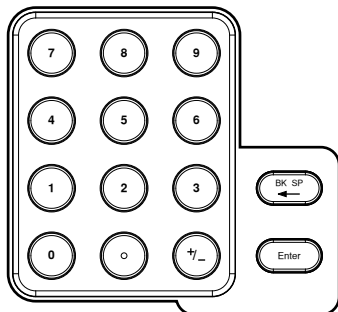

The numeric keypad is used to enter values and parameters. It is often used in conjunction with the arrow keys and scroll wheel.

TG output port

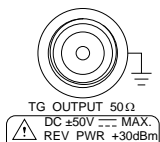

The Tracking Generator (TG) output source.

- N-type: female
- Input impedance: 50Ω
- Output power: -50dBm to 0dBm
- Maximum reversed power: +30dBm

USB A, Micro SD



USB A port, Micro SD port for saving/recalling settings/files.

Rear Panel

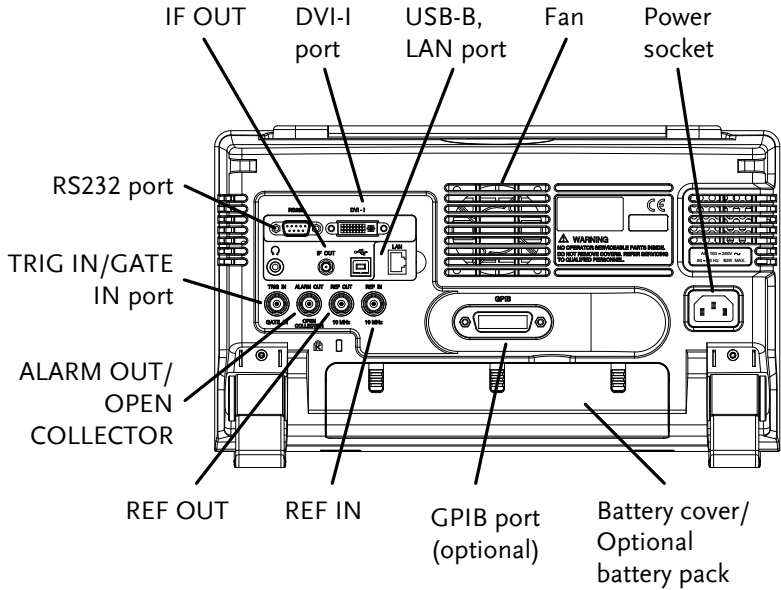

RS232

RS232

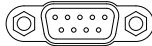

RS232 9 pin DSUB port.

IF OUT

IF OUT



SMA IF Out port.

DVI-I

DVI - I



DVI video out port. Supports SVGA (800X600) @ 60Hz.

Fan

Power Socket

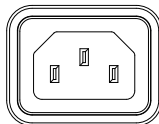

Power Socket:
100~240V, 50/60Hz.

Battery pack

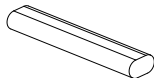
Voltage: 10.8V
Capacity: 5200mAH

REF IN

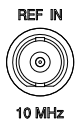

BNC female reference input.

REF OUT

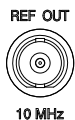
BNC female reference output:
10MHz, 50Ω impedance

Security Lock



ALARM OUT

BNC female open collector Alarm
output.

TRIG IN/GATE IN

BNC female 3.3V CMOS trigger
input/gated sweep input.

Phone

3.5mm stereo headphone jack
(wired for mono operation)

USB B



USB B Device port. USB 1.1/2.0

LAN







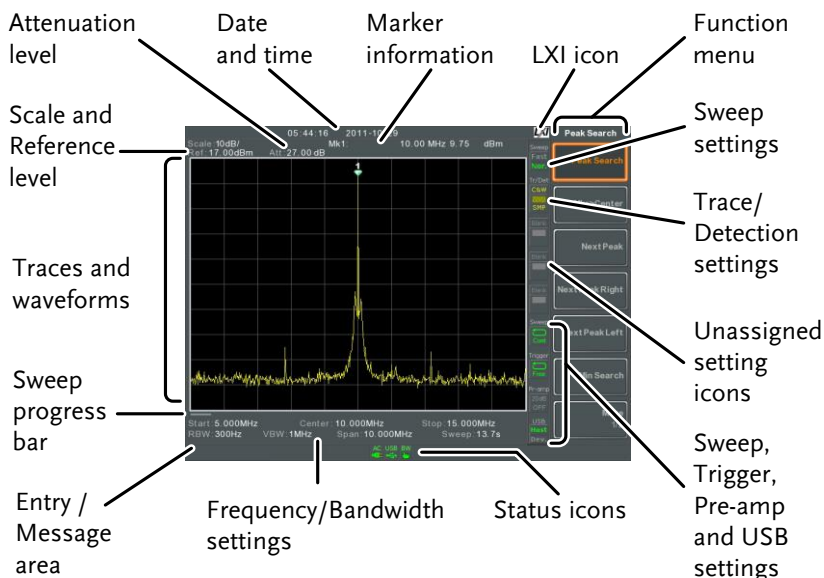

RJ-45 10Base-T/100Base-Tx

Display























- Scale Displays the vertical scale of the vertical grid. For details, see page 49.
- Reference level Displays the reference level. For details, see page 48.
- Attenuation Displays the vertical scale (attenuation) of the input signal. For details, see page 49.
- Date/Time Displays the date and time. See page 116 for details.
- Marker information Displays marker information. For details see page 90.

LXI icon	This icon indicates the status of the LXI connection. For details, see page 268.
Function menu	Soft menu keys associated with the F1 to F7 function keys to the right of the display.
Sweep Mode	 This icon displays the sweep mode, as set by the Sweep Mode key. See page 75.
Sweep settings	 Sweep icon that shows the sweep status. See page 69 for details.
Trace and detection settings	 Trace icon that shows the trace type and the detection mode used for each trace. See from page 77 for details.
Blank	 Unassigned setting icons.
Trigger settings	 Trigger icon that shows the trigger status. See page 85 details.
Pre-amp settings	 Pre-amplifier icon that shows the Pre-amplifier status. See from page 60 for details.
USB settings	 Displays the status of the USB A port.
Status Icons	Displays the interface status, power source status and alarm status, etc. See the Status Icon Overview on page 24 for a list of the status icons.

Frequency/ Bandwidth settings	Displays the Start, Center and Stop frequencies, RBW, VBW, Span and Sweep settings.
Entry/Message area	This area is used to show system messages, errors and input values/parameters.
Trace and waveforms	Main display showing the input signals, traces (page 77), limit lines (222) and marker positions (90).
Sweep progress bar	The sweep progress bar shows the progress of slow sweeps (greater than 2 seconds).

Status Icon Overview

3G Adapter		Indicates that the 3G adapter is installed and turned on.
Demo Kit		Indicates that the demo kit is installed and turned on.
PreAmp		Indicates that the pre amplifier is on.
AC		Shown when running on AC power.
AC Charge		Shown when the AC power is charging the battery.
Alarm Off		Alarm buzzer output is currently off.
Alarm On		Alarm buzzer output is currently on.
Amplitude Offset		Indicates that the amplitude-shift is active. This icon appears when amplitude-related functions are used: Reference level offset Amplitude Correction Input Z = 75Ω and Input Z cal >0
Battery indicator		Indicates the battery charge.
Bandwidth Indicator		Indicates that the RBW or VBW settings are in manual mode.

Average		Indicates that the Average function is active.
External Lock		Indicates that the system is now locked and refers to the external reference input signal
External Trigger		External trigger signal is being used.
Math		Trace math is being used.
Sequence Indicator		Shown when a sequence is running.
Sweep Indicator		Indicates that the sweep time is manually set.
Tracking generator		Indicates that the tracking generator is turned on.
TG Normalization		Indicates that the tracking generator has been normalized.
Wake-up clock		Indicates that the wake-up clock is turned on.
USB		Indicates that a USB flash drive is inserted into the front panel and is recognized.
Micro SD		Indicates that a micro SD card is inserted into the front panel and is recognized.

First Use Instructions

Use the procedures below when first using the GSP-9330 to tilt the stand, insert the battery pack, power up the instrument, set the internal clock, set the wake-up clock, update the firmware and to restore the default settings. Lastly, the Conventions sections will introduce you to the basic operating conventions used throughout the user manual.

Tilting the Stand

Description The GSP-9330 has two adjustable rubber feet that can be used to position the instrument into two preset orientations.

Upright Position Tuck the feet under the bottom of the instrument to stand the instrument upright.

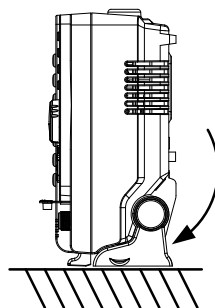

Leaning Position Pull the feet back to have the instrument leaning back.

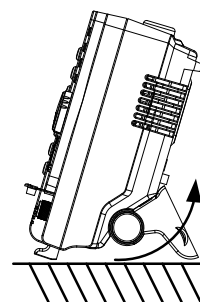

Inserting the Battery Pack

Description The GSP-9330 has an optional battery pack. The battery should be inserted before power is connected to the AC power socket and before the unit is turned on.

- Steps**
1. Ensure the power is off and the AC power is disconnected.
 2. Remove the battery cover.
 3. Insert the battery as shown in the diagram below.
 4. Replace the battery cover.

Display Icon



The battery icon is displayed when GSP-9330 is running on battery power.

Insertion Diagram

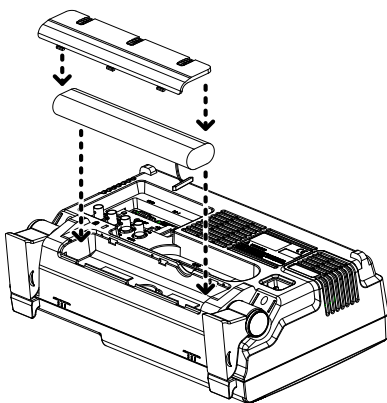

Power UP

Steps

1. Insert the AC power cord into the power socket.
2. The power button exterior will be lit blue to indicate that the GSP-9330 is in standby mode.

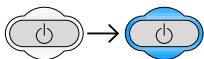

3. Press the power button for a few seconds to turn the GSP-9330 on.
4. The power button will turn orange and the GSP-9330 will start to boot up.

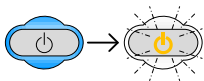

Note

It takes a little less than 1 minute for the GSP-9330 to fully startup.

Power Down

Description	<p>The GSP-9330 has two methods to power down: Normal and Forced Power Down.</p> <p>The normal power down method will save the system state and end any running processes. The state is saved for the next time the instrument is turned back on.</p> <p>The forced power down method only does a minimum state save.</p>
-------------	---

Normal Power Down	<p>Press the power button. The system will automatically handle the power down procedure in the following order:</p> <ul style="list-style-type: none">• The system state is saved.• Outstanding processes are closed in sequence.• The LCD backlight is turned off.• The system enters standby mode (the power key changes from orange to blue).
-------------------	--



Note

The process takes ~10 seconds.

Forced Power Down	<p>Press and hold the power button for ~4 seconds until the system turns off and the power button turns blue.</p>
-------------------	---



Note

The forced power down mode might cause the GSP-9330 to perform a longer system check the next time it is powered up.

Setting the Date, Time and Wake-Up Clock

Description The GSP-9330 can be setup to power-up automatically using the Wakeup Clock function. This feature is useful to wake-up the instrument early and eliminate settling time.

System Date Example: Set the System Date to July 1, 2016

1. Press  > *Date/Time*[F4] > *Set Date*[F1] > *Year*[F1].
 2. Press *2016* > *Enter*[F1].
 3. Press *Month*[F2] > *7* > *Enter*[F1].
 4. Press *Day*[F3] > *1* > *Enter*[F1].
 5. Press *Return*[F7].
-



Note

The System Date will be shown at the top of the display.

System Time Example: Set the System Time to 9.00 AM

1. Press  > *Date/Time*[F4] > *Set Time*[F2] > *Hour*[F1].
2. Press *9* > *Enter*[F1].
3. Press *Minute*[F2] > *0* > *Enter*[F1].
4. Press *Second*[F3] > *0* > *Enter*[F1].
5. Press *Return*[F7].



Note

The System Time will be shown at the top of the display.

System Wake-Up
Clock

Example: Set the GSP-9330 to wake up at 9.00 AM

1. Press  > *Date/Time*[F4] > *Wake-Up Clock*[F3] > *Select Clock*[F1].
 2. Press *Clock 1*[F1] ~ *Clock 7*[F7] to choose a clock (1 ~ 7).
 3. Press *State*[F2] to turn the wake up clock on/off.
 4. Press *Hour*[F3] > 9 > *Enter*[F1].
 5. Press *Minute*[F4] > 0 > *Enter*[F1].
 6. Press [F5] and choose *Rept.* (Repeat) or *Single*.
 7. Press *Select Date*[F6] and select a day.
 8. Press *Return*[F7] to save the Wake-Up Clock settings.
-



Note

The system time is kept with the CR2032 clock battery. If the system time/ wake up clock can no longer be set, please replace the clock battery. See page 282.

Firmware Update

Description The GSP-9330 allows the firmware to be updated by end-users. Before using the GSP-9330, please check the GW Instek website or ask your local distributor for the latest firmware.

System version Before updating the firmware, please check the firmware version.

1. Press **System** > *System Information* [F1].
2. The firmware will be listed on the display.



3. Press any other main/control/file/marker /auxiliary key to exit out of the System Information screen.
4. To upgrade the firmware, insert the new firmware onto a USB flash drive or Micro SD card and put the drive/card into the appropriate front panel port. The firmware files should be located in a directory named "gsp932".

5. Press  > More 1/2[F7] > Upgrade[F2].
6. The spectrum analyzer will automatically find the firmware on the USB flash drive and start to update the firmware. When finished, the message “Upgrade is finished” will be shown at the bottom of the screen followed by “Rebooting”.



7. The system will automatically restart after the rebooting message.



Note

The upgrade process may take a few minutes.

Restoring Default Settings

Description

The factory default settings or user presets can be easily restored using the Preset key on the front panel. By default, the factory default settings are restored with the Preset key.

For details on how to configure the preset settings, please see page 119.

Steps

1. Press .
2. The spectrum analyzer will load the preset settings.

Conventions

The following conventions are used throughout the user manual. Read the conventions below for a basic grasp of how to operate the GSP-9330 menu system and front panel keys.

Soft Menu keys The F1 to F7 function keys on the right side of the display correspond directly to the soft-menu keys on their left.

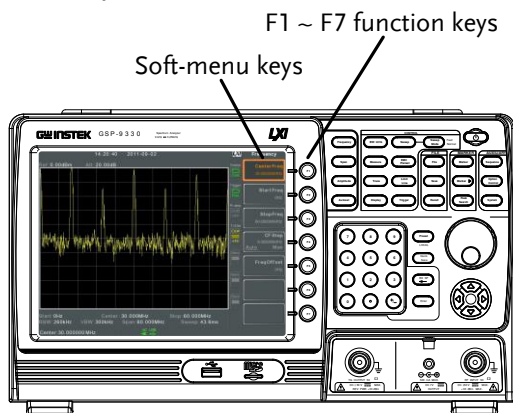

Input Parameter Values



Selecting this type of menu key will allow you to enter a new value with the numeric keypad or increment/decrement the value using the scroll wheel.

Toggle State

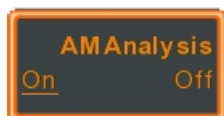

Pressing this menu key will toggle the state.

Toggle State &
Input Parameter



Pressing this menu key will allow you to toggle the state of the function between Auto and Man(ual) state. When in the Man state, the parameter value can be manually edited. Use the numeric keypad to enter the new value or use the scroll wheel to increment/decrement the current value.

Sub Menu

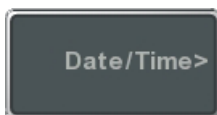

Pressing this menu key will enter a submenu.

Sub Menu to
select parameter



Pressing this menu key will enter a submenu to select a parameter.

Active Function

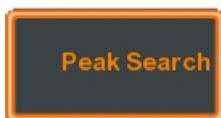

Pressing this type of menu key will activate that function. The menu key will be highlighted to show it is the active function.

Parameter input

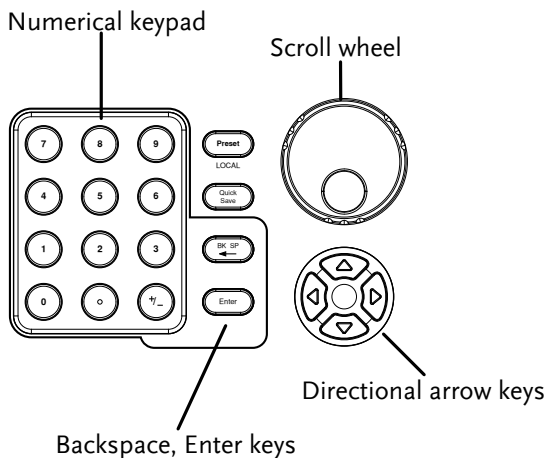

Parameter values can be entered using the numeric keypad, the scroll wheel and occasionally with the arrow keys.

Using the numeric keypad

When prompted to enter a parameter, use the number keys (0~9), the decimal key (.) and the sign key (+/-) to enter a value. After a value has been entered, the soft-menu keys can be used to select the units.

The value of the parameter is shown at the bottom of the screen as it is edited. Values can include decimal points for non-integer values or for entering dot-decimal notation for IP addresses.

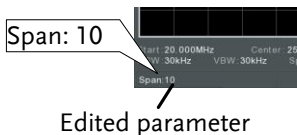

Back Space

Use the backspace key to delete the last character or number entered.

Using the scroll wheel

Use the scroll wheel to alter the current value. Clockwise increases the value, anti-clockwise decreases the value.

Directional arrows

Use the directional arrows to select discrete parameters or to alter values by a coarser resolution than the scroll wheel. Left decreases the value, right increases the value.

BASIC OPERATION

Frequency Settings	41
Center Frequency.....	41
Start and Stop Frequency	42
Center Frequency Step.....	43
Frequency Offset	44
Span Settings	45
Span	45
Full Span.....	46
Zero Span.....	46
Last Span	47
Amplitude Settings.....	48
Reference Level.....	48
Attenuation	49
Scale/Div.....	49
Auto Scale.....	50
Scale Type.....	50
View Scale	51
Vertical Scale Units.....	52
Reference Level Offset	52
Amplitude Correction	53
Create a Correction Set.....	54
Amplitude Correction On/Off.....	56
Delete Correction Set.....	57
Save Correction Set to Memory	57
Recall Correction Set From Memory	59
Input Impedance.....	59
Input Impedance Calibration.....	60
Using the Built-in Pre-Amplifier	60
Autoset.....	62
Using Autoset.....	62
Limiting the Autoset Vertical Search Range	63
Limiting the Autoset Horizontal Search Range.....	63
Bandwidth/Average Settings.....	64
Resolution Bandwidth Setting (RBW).....	64

Video Bandwidth Settings (VBW)	65
VBW/RBW Ratio.....	66
Average Trace.....	67
Average Type.....	68
EMI Filter	69
Sweep	70
Sweep Time.....	70
Single Sweep	71
Continuous Sweep.....	71
Gated Sweep Overview	72
Using the Gated Sweep Mode.....	73
Sweep Control / Sweep Mode	75
Trace	77
Selecting a Trace	77
Trace Math.....	79
Trace Detection Mode.....	81
Trigger.....	85
Selecting a Trigger Type	85
Free Run Mode	85
Activate Video Trigger.....	85
Activate External Trigger.....	87
Selecting the Trigger Mode	88
Set the Trigger Delay Time	89
Marker	90
Activating a Marker	91
Activate a Normal Marker	91
Move Marker Manually.....	92
Move Marker to Preset Locations	92
Activate Delta Marker.....	93
Move Delta Marker(s)Manually	94
Marker Functions.....	95
Marker Noise	95
Frequency Counter.....	96
VSWR	97
Move Marker to Trace	98
Show Markers in Table	99
Peak Search	100
Move Marker to Peak.....	100
Move Marker and Peak to Center.....	101
Search for Peaks.....	101
Peak Configuration.....	103
Peak Table.....	104
Display.....	106

Adjusting the LCD Brightness	106
Turning the LCD Backlight Off.....	106
Setting a Display Line (Reference Level Line).....	107
Using the Video Out Port	107
Setting the Display Mode	108
Spectrogram and Topographic Markers	111
Split Spectrum View	113
System Settings.....	115
System Information	115
Error Messages	115
Set the System Language	116
Set the Date and Time	116
Display the Date and Time on the Screen.....	117
Using the Wake-Up Clock.....	117
Alarm Output	118
Preset.....	119
Using the Preset Key	119
Save the User Preset Settings.....	119
Preset Type Settings	120
Power on Preset Settings	120

Frequency Settings

Center Frequency

Description The center frequency function sets the center frequency and centers the display to the center frequency.

Operation 1. Press **Frequency** > **Center[F1]** and enter the frequency and unit.

Range:	0kHz~3.25GHz
Resolution:	1Hz
Default	1.625GHz

Display

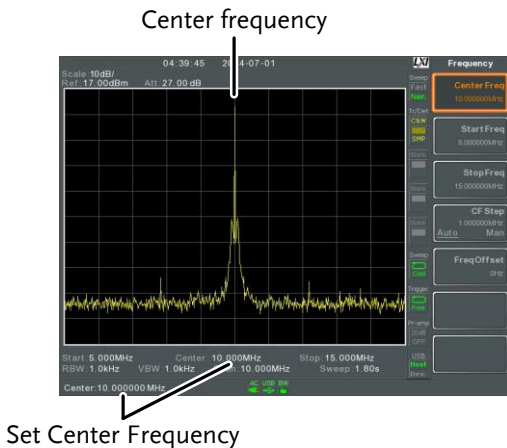

Start and Stop Frequency

Description The start/stop frequency function will set the start and stop frequency of the span.

- Operation**
- To set the start frequency, press **Frequency** > *Start Freq[F2]* and enter the frequency and unit.
 - To set the stop frequency, press **Frequency** > *Stop Freq[F3]* and enter the frequency and unit.
- Range: 0kHz~3.25GHz
 Resolution: 1Hz
 Default Start frequency: 0Hz
 Default Stop frequency: 3.25GHz

Display

Start Frequency

Stop Frequency



Start Frequency

Stop Frequency

 **Note**

The start and stop frequency can change when the span settings are used.
 The stop frequency must be set higher than the start frequency (for spans \neq 0), otherwise the span will be automatically set to 100Hz.

Center Frequency Step

Description The CF Step function sets the step size of the center frequency when using the arrow keys or scroll wheel.

When the scroll wheel or arrow keys are used to alter the center frequency, each turn/press will move the center frequency by the step size specified by the CF Step function.

In auto mode, the center frequency step size is equal to 10% (1 division) of the span.

- Operation**
1. Press **Frequency** > *CF Step*[F4] and set the CF Step to Auto or Man.
 2. If Man was selected, set the frequency and unit of the center frequency step size.

Manual Range: 0Hz~3.25GHz
 Auto range: 1/10 of span frequency

Display

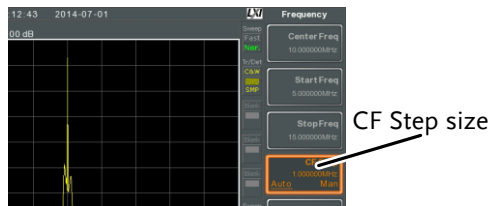

Frequency Offset

Description The Freq Offset function allows you to add an offset to the Center, Start and Stop frequencies as well as the marker frequencies. The offset value does not affect displaying the trace on the display.

Operation 1. Press **Frequency** > *Freq Offset[F5]* and set the offset value.

The Center, Start, Stop and Marker frequencies are updated accordingly.

Offset Range: 0Hz~100GHz

Display

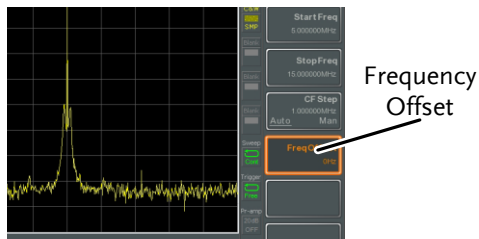

Span Settings

Span

Description The Span function will set the frequency range of the sweep. The sweep will be centered around the center frequency.

Setting the span will alter the start and stop frequencies.

Operation 1. Press **Span** > *Span[F1]* and enter the span frequency range and unit.

Range: 0kHz~3.25GHz
 Resolution: 1Hz
 Default Span: 3.25GHz

Display

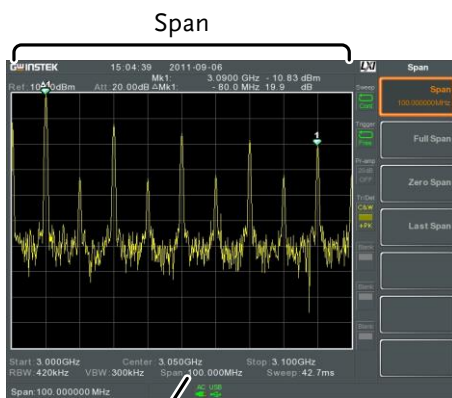

Full Span

Description The Full Span function will set the span to the full frequency range.

 This function will set the start and stop frequencies to 0Hz and 3.25GHz respectively.

Operation 1. Press  > *Full Span*[F2].

Zero Span

Description The Zero Span function will set the frequency range of the sweep to 0Hz and fixes the start and stop frequencies to the center frequency. The Zero Span function measures the time domain characteristics of the input signal at the center frequency. The horizontal axis is displayed in the time domain.

Operation 1. Press  > *Zero Span*[F3].

 The span changes accordingly.

Display

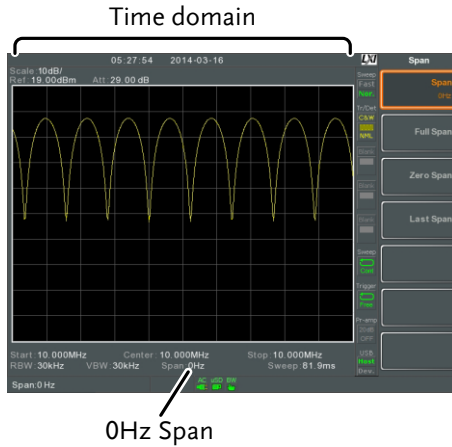

Example: Amplitude modulation



Note

The measurement functions such as TOI, SEM, CNR, CTB, CSO, ACPR, OCBW, phase, Jitter, Harmonics, NdB, P1dB and other measurement functions are not available with the zero span setting:

Last Span

Description

The last span function returns the spectrum analyzer to the previous span settings.

Operation

1. Press Span > *Last Span*[F4].

Amplitude Settings

The vertical display scale is defined by the reference level amplitude, attenuation, scale and external gain/loss.

Reference Level

Description The reference level defines the absolute level of the amplitude on the top graticule in voltage or power.

Operation 1. Press **Amplitude** > *Ref Level[F1]* and enter the reference level amplitude and unit.

Range: -120dBm ~ 30dBm
 Units: dBm, -dBm, W, V, dBV
 Resolution: 1dBm

Display

Ref Level reading Reference Level

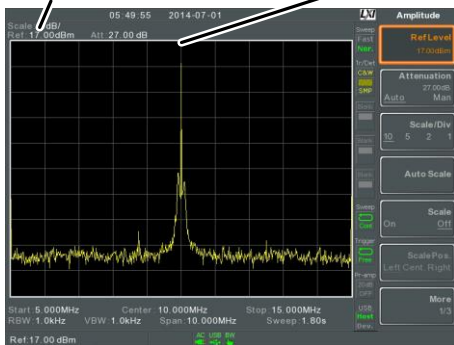

Attenuation

Description The attenuation of the input signal level can be set to automatic (Auto) or manual (Man). When the attenuation is set to Man, the input attenuator can be changed manually in 1dB steps.

- Operation**
1. Press **Amplitude** > *Attenuation*[F2] and select Auto or Man.
 2. If Man was selected, enter the attenuation level and unit.

Range: 0dBm ~ 50dBm
 Units: dBm
 Resolution: 1dB

Display

Attenuation level

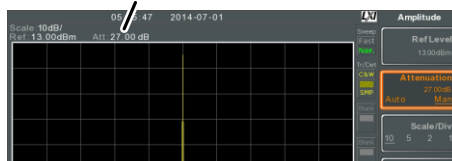

Scale/Div

Description Sets the logarithmic units for the vertical divisions when the scale is set to Log.

- Operation**
1. Press **Amplitude** > *Scale/Div*[F3] repeatedly to select the vertical division units.

Unit Range: 10, 5, 2, 1

Display



Note

The Scale/Div function is only selectable when the scale is set to Log (logarithmic).

Auto Scale

Description

The Auto Scale function will automatically set the Scale/Div, Reference level and Attenuation (if set to Auto) to best display the spectrum.

Operation

1. Press  > *Auto Scale*[F4] to turn the Auto Scale function on.



Note

This function is applicable to both the linear and logarithmic scales.

Scale Type

Description

Sets the vertical scale in linear or logarithmic units.
By default the linear scale is set to volts and the logarithmic scale is set to dBm.

Operation

1. Press  > *More*[F7] > *Scale Type*[F2] and set the vertical scale to Log or Lin.



Note

If the unit scale is changed (i.e. dBm → volts), the *displayed* vertical scale type will remain in the set linear or logarithmic setting.

View Scale

Description The Scale function turns the vertical scale on/off. The value of each graticule division is displayed with the same units that are used for the Ref Level settings.

- Operation**
1. Press **Amplitude** > **Scale[F5]** to toggle the Scale on or off.
 2. Press **Scale Pos.[F6]** to toggle the position of the scale when on.

Scale position: Left, Center, Right

Display

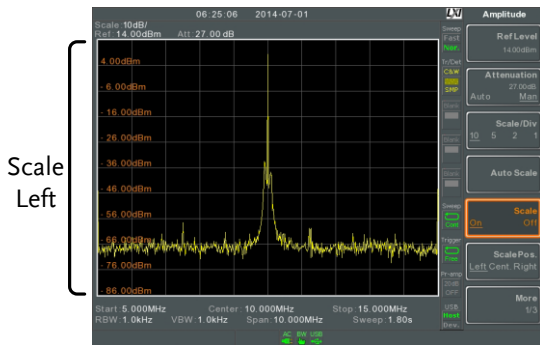



The vertical scale is displayed on the left-hand side by default.

Vertical Scale Units

Description	Change the vertical units for both linear or logarithmic scales.
Operation	<ol style="list-style-type: none"> 1. Press  > <i>More[F7]>Y Axis[F1]</i> and then choose the desired units. 2. The units are changed accordingly. <p>Units: dBm, dBmV, dBuV, Watts, Volts</p>

Reference Level Offset

Description	<p>The Reference Level Offset function sets an offset value to the reference level to compensate for any loss or gain from an external network or device.</p> <p>The offset value does not affect the input attenuation or the on-screen trace.</p> <p>This setting will change the reference level readout, the scale readout and the marker readout.</p>
Operation	<ol style="list-style-type: none"> 1. Press  > <i>More[F7]>RefLvlOffset[F4]</i> and set the offset level and unit. 2. To remove the offset level, set the reference offset to 0 dB. <p>Range: 0dB ~ 50dB</p>
Display Icon	 The AMP icon is displayed at the bottom of the screen.

Example:

Ref: 0dBm

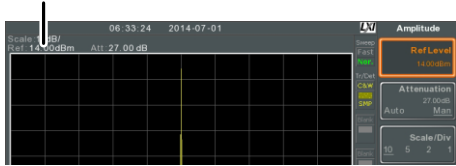

Before reference level offset(offset: 0dB)

Ref: 10dBm Reference level offset: 10dB



After reference level offset (offset: 10dB)

Amplitude Correction

Description Amplitude correction adjusts the frequency response of the spectrum analyzer by altering the amplitudes at specified frequencies. This allows the spectrum analyzer to compensate for loss or gain from an external network or device at certain frequencies.

Range

Correction Sets:	5 sets of 20 points
Amplitude:	-40dB to +40dB
Amplitude Resolution:	0.1dB
Frequency:	9kHz to 3.25GHz
Frequency Resolution:	1Hz

Display

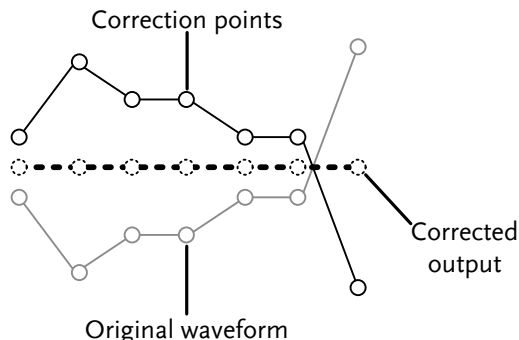

Example: The diagram above shows how amplitude correction is used to compensate for any losses or gains at specific frequencies.

Create a Correction Set

Description	The GSP-9330 can create and edit up to 5 sets of correction points. The correction points and associated values are all tabulated for ease of use.
-------------	--

Operation	1. Press Amplitude > More[F7] > Correction[F3] > Select Correction[F1] and choose a correction set to edit/create.
-----------	--

Correction set:	1~5
-----------------	-----

2. Press *Edit*[F3].

The GSP-9330 will split into two screens. The top screen will show the waveform and the bottom screen will provide an overview of the correction points.

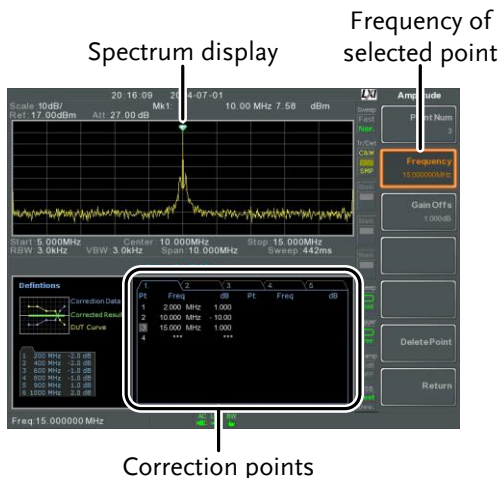

3. Press *Point Num*[F1] and choose a point number to edit. Point numbers can only be created in order. For example Point Num 2 can only be selected after Point Num 1 is created, and point Num 3 can only be selected after Point Num 2 is created and so on.

Point Num: 1~20

4. Press *Frequency*[F2] and choose the frequency of the selected point.
5. Press *Gain Offset*[F3] and choose the amplitude of the selected point. The units will be the same as those used for the vertical scale.

The frequency of the point values are displayed in the correction table on the bottom display.

Correction Table

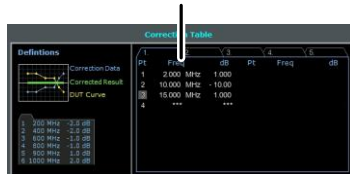

6. Repeat steps 3 to 5 for any other correction points.
7. To delete the selected point, press *Delete Point*[F6].
8. Press *Return*[F7]>*Save Correction*[F5] to save the correction set.



Note

Note that the correction points are automatically sorted by frequency (low → high). The correction set must be saved before it can be turned on.

The frequency values *displayed* in the correction table are rounded down for display purposes only. The actual frequency for each point can be seen in the Frequency soft-key.

Amplitude Correction On/Off

Description Any one of the 5 correction sets can be turned on.

Activate Correction 1. Press **Amplitude** > *More*[F7]>*Correction*[F3]>*Correction Set*[F1] and choose a correction set.

Correction Set: 1~5

2. Press *Correction*[F2] and toggle correction on.

Deactivate
Correction

1. Press  > *More*[F7]>*Correction*[F3]>
Correction[F2] to turn correction back off.

Delete Correction Set

Operation

1. Press  > *More*[F7]>*Correction*[F3]>
Correction Set[F1] and choose the correction set to delete.

Correction Set: 1~5

2. Press *Delete Correction*[F6].
The selected correction set will be deleted.

Save Correction Set to Memory

Operation

1. Press  > *Save To*[F1] and choose the save location.

Location: Register, Local, USB, SD

2. Press *Type*[F2]> *Correction*[F5].
3. Press *Data Source*[F3] and choose a correction.

Correction Set: Correction 1~5

4. To name the file, press *Name*[F5].
Name the selected file using the F1~F7 keys, as shown below or use the numeric keypad to enter numbers.

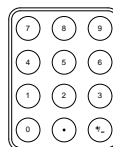

Limitations:

- *No spaces*
- *Only 1~9, A~Z, a~z characters allowed*

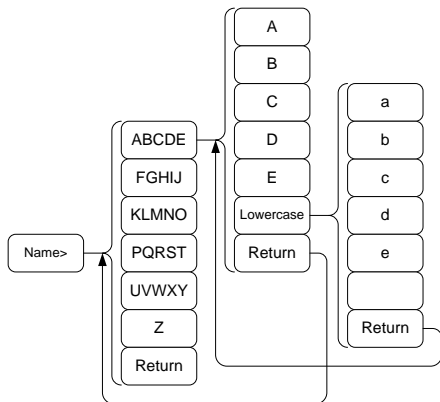

5. The filename appears on the bottom of the screen as it is created.

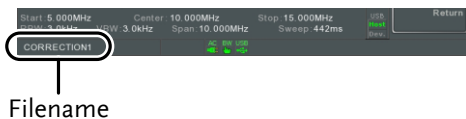

Press to confirm the filename.



If the file name is not user-defined, a file name will be automatically created in the following format:

File name: type_data source_file number.file extension

Example: Correction1_0.cor

The file number parameter is incremented each time the same file type is created.

6. Press *Save Now*[F7].
7. The correction set will be saved to the selected location. For more information on Save and Recall, please see page 258.

Recall Correction Set From Memory

- | | |
|-----------|--|
| Operation | <ol style="list-style-type: none"> 1. Press  > <i>Recall</i>[F1] and choose the recall location:

Location: Register, Local, USB, SD 2. Press <i>Type</i>[F2] > <i>Correction</i>[F5]. 3. Use the scroll wheel to select a previously saved correction set from the file directory. 4. Press <i>Destination</i>[F3] and choose a correction set.

Correction Set: Correction 1~5 5. Press <i>Recall Now</i>[F4]. 6. The current correction set will be recalled from the selected location. For more information on Save and Recall, please see page 258. |
|-----------|--|

Input Impedance

Description	Sets the input impedance to 75Ω or 50Ω.
-------------	---

- | | |
|-----------|---|
| Operation | <ol style="list-style-type: none"> 1. Press  > <i>More</i>[F7] > <i>More</i>[F7] > <i>Input Z</i>[F1] to toggle the input impedance. |
|-----------|---|

Range: 75Ω, 50Ω

Input Impedance Calibration

Description When an external impedance converter module (optional accessory ADP-101) is used to convert the impedance of a device from 50Ω to 75Ω, some external loss can be induced. The Input Z Cal function can be used to compensate for these losses with an offset value.



Note

The Input Z Cal function is only functional when the input impedance is set to 75Ω.

Operation

1. Press  > More[F7] > More[F7] > Input Z Cal[F2] and set the impedance offset.

Range: 0dB to +10dB
 Resolution: 1dB

Display Icon



The AMP icon is displayed at the bottom of the screen when Input Z Cal ≠ 0dB and Input Z is = 75Ω.

Using the Built-in Pre-Amplifier

Description

The built-in pre-amplifier boosts weak input signals, such as EMI testing signals, to levels that are easy to handle, over the entire frequency range. The built-in pre-amplifier on the GSP-9330 has a nominal gain of 20dB.

In the Auto setting, the pre-amplifier will be automatically turned on when the reference level is less than -30dBm. When the reference level is greater than -30dBm, the pre-amplifier

is turned off. The bypass setting turns the pre-amplifier off.

Operation

1. Press **Amplitude** > **More[F7]** > **Preamp[F5]** to toggle the Preamp state.

Range:

Auto, Bypass

Display Icon



The Pr-amp icon indicates that the pre amplifier is on.

Example:

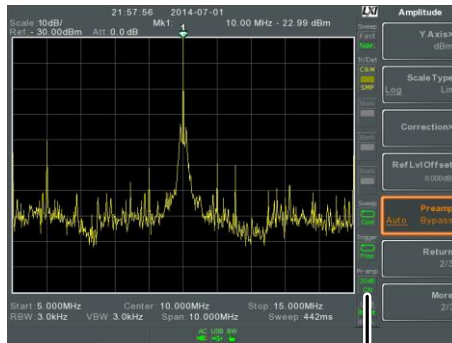

Pr-amp icon

 **Note**

When the pre-amplifier is on, the attenuator becomes fixed at 0dB (i.e. Attenuation = 0dB).

Autoset

The Autoset function searches the peak signals in two stages (full span & 0Hz - 100MHz limited span), picks the signal peak with the maximum amplitude, and then shows it in the display.

Using Autoset

Operation

1. Press **Autoset** > *Autoset[F1]*.

Autoset Range

Amplitude: -80dBm ~ +20dBm
Span: 0Hz ~ 3.25GHz

Example:

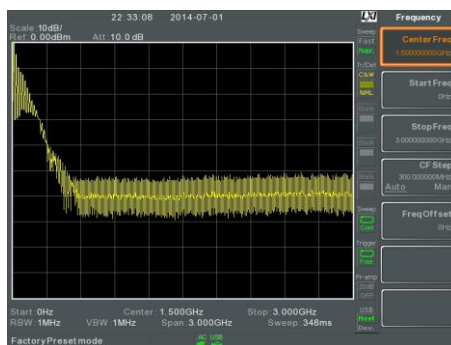

Before Autoset, preset state

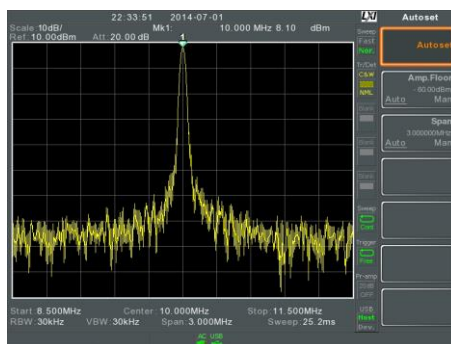

After Autoset



Note

RBW, VBW and sweep settings are reset to Auto when the Autoset function is used.

Limiting the Autoset Vertical Search Range

Description You can set the amplitude floor so that the signals lower than the setting will be ignored by the Autoset search.

- Operation**
1. Press  > *Amp.Floor*[F2] and switch the range from Auto to Man.
 2. Enter the amplitude limit and unit for the Autoset search.

Range: -60 to +20dBm



Note

See page 50 for setting the amplitude units.

Limiting the Autoset Horizontal Search Range

Description You can change the frequency span limit in the display to get a better view of the Autoset result. By default, the frequency span after Autoset is set at 3MHz.

- Operation**
1. Press  > *Span*[F3] and switch the range from Auto to Man.
 2. Enter the span frequency for the Autoset search.

Manual Range: 100Hz to 3.25GHz

Bandwidth/Average Settings

BW/AVG key sets the resolution bandwidth (RBW), video bandwidth (VBW) and averaging functions. The resolution, sweep time, and averaging are in a trade-off relationship, so configuration should be done with care.

Resolution Bandwidth Setting (RBW)

Description	RBW (Resolution Bandwidth) defines the width of the IF (intermediate frequency) filter that is used to separate signal peaks from one another. The narrower the RBW, the greater the capability to separate signals at close frequencies. But it also makes the sweep time longer under specific frequency spans (the display is updated less frequently).
-------------	--

SPAN-RBW Auto relationship	When the RBW is set to Auto, the RBW is determined by the frequency span. This is shown in the table below.
----------------------------	---

SPAN-RBW relationship in Auto mode.	Span (Hz) ≤ RBW (Hz)		Span (Hz) ≤ RBW (Hz)	
	200	1	650k	3000
650	3	2M	10000	
2k	10	6.5M	30000	
6.5k	30	20M	100000	
20k	100	65M	300000	
200k	1000	200M	1000000	

Operation	<ol style="list-style-type: none"> 1. Press  > <i>RBW[F1]</i> and set the RBW to Auto or Man. 2. Set the resolution bandwidth and unit for Man mode. 						
	<table border="0" style="width: 100%;"> <tr> <td style="padding-right: 20px;">Mode:</td> <td>Auto, Man</td> </tr> <tr> <td>Frequency Range(3dB):</td> <td>1Hz~1MHz (1-3-10 step)</td> </tr> <tr> <td>Frequency Range(6dB):</td> <td>200Hz, 9kHz, 120kHz, 1MHz</td> </tr> </table>	Mode:	Auto, Man	Frequency Range(3dB):	1Hz~1MHz (1-3-10 step)	Frequency Range(6dB):	200Hz, 9kHz, 120kHz, 1MHz
Mode:	Auto, Man						
Frequency Range(3dB):	1Hz~1MHz (1-3-10 step)						
Frequency Range(6dB):	200Hz, 9kHz, 120kHz, 1MHz						

 **Note** If the setting is in Auto mode, using the scroll wheel or arrow keys will automatically set the RBW to manual mode.

Display Icon  The BW icon is displayed at the bottom of the screen when the RBW is in Man mode.

 **Note** If the RBW settings have an asterisk (*), it indicates that the -6dB filters are used.

Video Bandwidth Settings (VBW)

Description VBW (Video Bandwidth) defines the smoothness of the trace on the display. Combined with RBW, VBW defines the ability to sort out the target signal from surrounding noise or adjacent peaks.

Operation	<ol style="list-style-type: none"> 1. Press  > <i>VBW[F2]</i> and set the VBW to Auto or Man. 2. Set the video bandwidth and unit for Man mode.
-----------	---

Mode: Auto, Man
 Frequency Range(3dB): 1Hz~1MHz (1-3-10 step)

Display Icon  The BW icon is displayed at the bottom of the screen when the VBW is in Man mode.

VBW/RBW Ratio

Description The VBW/RBW function is used to view the ratio between the video bandwidth and the resolution bandwidth.

The VBW/RBW ratio is altered by setting the RBW and or VBW settings, see page 64 & 65 respectively.

- View VBW/RBW ratio**
1. Press .
 2. The ratio is displayed on the *VBW/RBW[F3]* soft key.

Display



Tip Signals that are masked by the noise floor level should have a ratio of less than 1 to smooth the noise out.

Signals with strong frequency components should use a ratio equal to or greater than 1.

Average Trace

Description The Average function averages the trace for a user-defined number of times before it is displayed. This feature smooths the noise level, but has the drawback of slowing down the display update rate.

- Operation**
1. Press **BW/Avg** > *Average*[F4] and toggle Average on or off.
 2. Set the number of averages.

Range: 4 ~ 200
 Default: 20

Display Icon  The AVG icon is displayed at the bottom of the screen when the Average function is on.

Example:

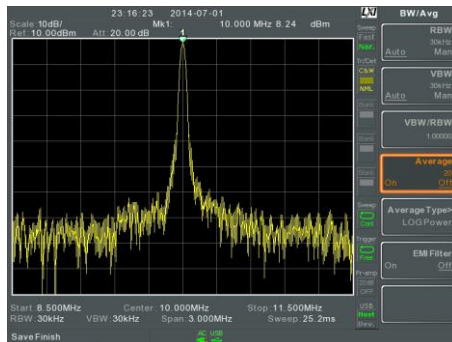

Average:Off

Number of traces that have been averaged

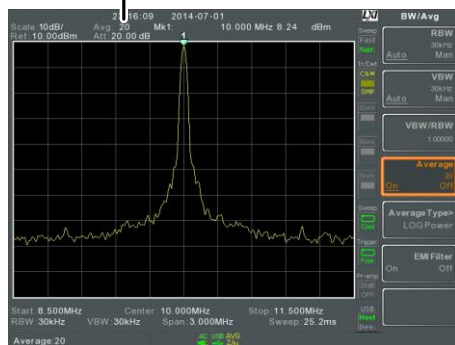

Average: On (20x)

Average Type

Description

The Average Type function determines how the GSP-9330 determines the average value.

LOG Average: Averages the trace points on a logarithmic scale.

Volt Average: Averages the amplitudes of the trace points on a linear voltage scale.

Power Average: Averages the trace points on a logarithmic scale in watts.

Operation

1. Press **[BW/Avg]** > *Average Type*[F5] and choose the average type.

Range: LOG Power, Volt Average, Power Average
 Default: LOG Power

EMI Filter

Description The built-in EMI filter is used for specific measurement situations such as EMI average detection, where a higher level of sensitivity is required compared to the standard configuration. When turned on, the RBW is set to -6dB, indicated by an asterisk (*).

When any measurement functions are turned on (see page 121 for details), the EMI filter is automatically disabled. Conversely if the EMI filter is turned on, any measurement functions are turned off.

Operation 1. Press  > *EMI Filter*[F6] and toggle EMI filter on or off.





Note

See the specifications for details on the EMI filter, page 332.

Sweep

The GSP-9330 has a number of sweep options including setting the sweep time, the sweep run mode (continuous, single) and sweep mode (fast, slow). The GSP-9330 also has gated sweep modes.

Sweep Time

Description	Sweep time defines the length of time the system takes to "sweep" the current frequency span. Note, however, that sweep time and RBW/VBW are in a trade-off. Faster sweep times update the display more frequently but make RBW and VBW wider, reducing the capability to separate signals at close frequencies.						
Operation	<ol style="list-style-type: none"> 1. Press  > <i>Sweep Time[F1]</i> and toggle the Sweep time to Auto or Man. 2. Set the sweep time for the Man mode. <table border="0" style="margin-left: 20px;"> <tr> <td style="padding-right: 10px;">Mode:</td> <td>Auto, Man</td> </tr> <tr> <td style="padding-right: 10px;">Range:</td> <td>1.14ms ~ 1000s (span=100Hz, RBW=3kHz)</td> </tr> <tr> <td style="padding-right: 10px;">Resolution:</td> <td>46.6us ~ 1000s (span=0Hz, RBW= 1MHz)</td> </tr> </table> 	Mode:	Auto, Man	Range:	1.14ms ~ 1000s (span=100Hz, RBW=3kHz)	Resolution:	46.6us ~ 1000s (span=0Hz, RBW= 1MHz)
Mode:	Auto, Man						
Range:	1.14ms ~ 1000s (span=100Hz, RBW=3kHz)						
Resolution:	46.6us ~ 1000s (span=0Hz, RBW= 1MHz)						
Display Icon	 The SWT icon will be displayed at the bottom of the screen when the sweep is in manual mode.						

Single Sweep

Description The single sweep function is used to perform a single sweep. When Sweep Single is pressed the GSP-9330 will perform a single sweep and then stop.

- Operation**
1. Press  > *Sweep Single*[F2] to put the spectrum analyzer into single sweep mode.
 2. Press *Sweep Single*[F2] again to perform a single sweep.

When a single sweep has been performed, you can still perform frequency, span, amplitude and other functions on the “frozen” trace.

Display Icon  The Sweep Single icon is displayed on the right-hand side of the screen when the sweep is in single mode.



Note

You must wait for the single sweep to finish before pressing the Single Sweep key again.

If a setting is changed whilst the spectrum analyzer is still sweeping, the single sweep will immediately start over.

Continuous Sweep

Description The GSP-9330 has two main sweeping run modes: single and continuous. Use the continuous mode to have the sweep constantly updated.

Operation 1. Press  > *Sweep Cont[F3]* to put the spectrum analyzer into continuous sweep mode.

Display Icon  The Sweep Cont icon is displayed on the right-hand side of the screen when the sweep is in continuous mode.

 Note The GSP-9330 will now continuously sweep unless the mode is changed to single sweep mode or if the system is waiting for a trigger condition.

Gated Sweep Overview

Description The Gated Sweep mode allows a trigger signal to dictate when the spectrum analyzer can sweep. This mode is useful for characterizing signals that are pulsed on and off, such as RF burst transmissions or for measuring spurious noise levels between transmission bursts.

Overview 1. The trigger signal must be synchronized to the period of the input signal (shown as RF burst below).

 2. The start of the gate time is produced from the positive or negative edge of the trigger signal + the delay time.

 3. The end of the gate time is determined by the set gate length.

 4. The gated sweep should not be positioned at either end of the transmission.

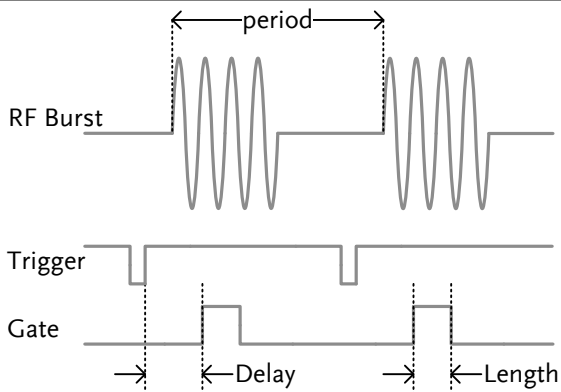

Example: The diagram above demonstrates the relationship between the input trigger, the input signal and the position of the gated sweep relative to the input signal.



Note

Please take into consideration RBW settling time. Setting the delay time too short may not leave enough time for the RBW filter to resolve.

Using the Gated Sweep Mode

Connection

1. Connect a trigger signal (3.3v CMOS) to the GATE IN port on the rear panel.





Note

RBW must be equal to or greater than 10kHz for the gated sweep mode function to be available.

Operation

1. Press **Sweep** > *GateDelay*[F5] and set the gate delay time.

2. Press  > *Gated Length[F6]* and set the gate time length.
3. Press  > *Gated Sweep[F4]* and turn the mode on.

Gate Delay: 0s ~ 1000s
 Gate Length: 58us ~ 1000s

Display Icon



The Sweep Gated icon is displayed when Gated Sweep is turned on.

Example:

The example below shows the spectrum of an FSK modulated signal when gated sweep mode is off.

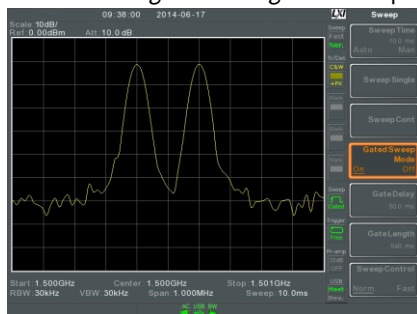

The example below shows the same signal with the gated sweep timed to sweep when only the desired frequency is output.





Note

Gate Delay and Gate Length must first be set before Gated Sweep is turned on.

Sweep Control / Sweep Mode

Description The Sweep Control function and the Sweep Mode key  toggles the Sweep Mode from Normal to Fast.

The Fast setting speeds up the signal processing and the display update rate to increase the overall sweep time. This mode is especially useful when the span is greater than 1MHz.

When set to *Normal*, signal processing and update rate is set to normal levels.

Operation 1. Press  > *Sweep Control [F7]* to toggle the Sweep Mode between *Norm.* and *Fast*.

OR

2. Press  and toggle the Sweep Mode between *Norm.* and *Fast*.

Display Icon  The Sweep icon is displayed on the right-hand side of the screen when the sweep is in either Fast or Normal mode.

Sweep Times

		Center Frequency = 1.625GHz Sweep Mode		
Span(Hz)	RBW (Hz)	AUTO	Norm.	Fast
3.25G	1M		169ms	84.8ms
2G	1M		104ms	52.2ms
1G	1M		52ms	31.1ms
500M	1M		31ms	16.8ms
200M	1M		13.4ms	6.72ms
100M	1M		6.7ms	3.36ms

50M	300k	10.7ms	716us
20M	100k	23.4ms	573us
10M	100k	11.7ms	286us
5M	30k	28.9ms	655us
2M	10k	101ms	1.96ms
1M	10k	50.9ms	1.31ms
500k	3k	6.88ms	6.88ms
200k	1k	22.9ms	22.9ms
100k	1k	9.83ms	9.83ms
50k	300	76.4ms	76.4ms
20k	100	219ms	219ms
10k	100	109ms	109ms
5k	30	710ms	710ms
2k	10	1.98s	1.98s
1k	10	994ms	994ms
500	3	2.65s	2.65s
200	1	2.65s	2.65s
100	1	2.65s	2.65s

Trace

The GSP-9330 is able to set the parameters of up to 4 different traces on the display at once. Each trace is represented by a different color and is updated with each sweep.

Selecting a Trace

Description	Each trace (1, 2, 3, 4) is represented by a different color. When activated, an icon for each trace color and function is shown to the left of the display. When a trace is selected, parameters can be set/edited from the trace menu.
-------------	---

Trace Color:	1: Yellow
	2: Pink
	3: Blue
	4: Orange

Trace Type	The type of trace used determines how the trace data is stored or manipulated before being displayed. The analyzer updates each trace according to the type of trace used.
------------	--

Clear and Write	The GSP-9330 continuously updates the display with each sweep.
-----------------	--

Hold Max/ Hold Min	The maximum or minimum points are maintained for the selected trace. The trace points are updated each sweep if new maximum or minimum points are found. The Hold Max setting also has a threshold setting. This setting will ensure only those values above the threshold are kept.
View	View will hold the selected trace and stop updating the trace data for the selected trace. Pressing <i>View</i> [F5] will display the trace data that was cleared using the <i>Blank</i> [F6] key.
Blank	Clears the selected trace from the display and stores trace data. The trace can be restored by pressing <i>View</i> [F5].

Display Icon
Example

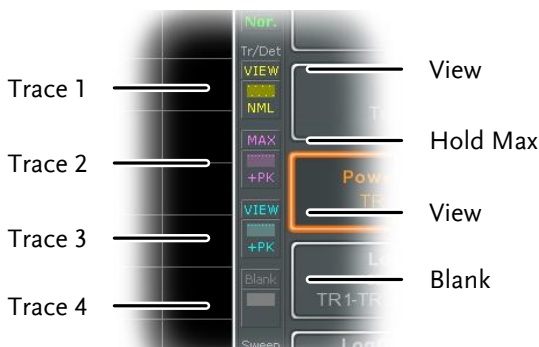

Operation

1. Press  > *Trace*[F1] and choose the trace number.

Trace: 1, 2, 3, 4

2. Select the trace type:

Clear & Write[F2]

Max Hold[F3]

Min Hold[F4]

View[F5]

Blank[F6]

3. If *Max Hold[F3]* was selected, set the threshold level.



Note

Traces, 2, 3 and 4 are set to *Blank* by default.

Trace Math

Description	Performs trace math from two traces (TR1, TR2) and stores the result in the currently selected trace. It also performs trace shift.
-------------	---

Math functions	Power Diff	Subtracts the TR1 amplitude data from the TR2 amplitude data. The TR1 data TR2 data are converted to watts. The result is converted back to dBm.
	Log Diff	Subtracts the TR1 amplitude data from the TR2 amplitude data and then adds a logarithmic reference. Both the TR1 and TR2 data is in dBm. The resultant trace of the subtraction is in dB. When the result is added to a logarithmic reference the resulting data is in dBm.

LOG Offset Adds a reference to the TR1 trace

Operation

1. Press  > *More[F1]>Trace Math[F1]*.
2. Press *TR1[F1]* and select the first trace source:

TR1: Trace 1,2, 3, 4*

3. Press *TR2[F2]* and select the second trace source:

TR2: Trace 1, 2, 3, 4*



Note

*You cannot select the current trace as the TR1 or TR2 trace sources. The current trace is designated by pressing  > *Select Trace>[F1]*.

4. Select the trace math function:

PowerDiff[F3]

LogDiff[F4]

LogOffset[F5]

5. If LogDiff was selected, set the reference level and unit.

LogDiff ref range: -120dBm ~ 30dBm

LogDiff ref units: dBm, W

6. If LogOffset was selected, set the offset level and unit.

LogOffset range: -50dB~+50dB

7. To turn trace math off, press the *OFF[F6]*.

Display Icon		The Math icon is displayed when trace math is turned on.
--------------	---	--

Trace Detection Mode

Description	Each time the spectrum analyzer samples data for each point on the trace, a number of samples are usually taken for each point, known as a sample bucket. The actual value of each point is determined by the detector from the samples in each bucket.
-------------	---

Each selected trace, (1, 2, 3, 4), can use a different detection mode.

Detection modes	Auto	Automatically chooses an appropriate mode based on the values of all the samples.
	Normal	While the signal level is constantly increasing or decreasing, the positive peaks are detected. Otherwise, the detection mode switches between positive peak and negative peaks. Useful for picking up burst phenomenon while avoiding excessive noise.
	Peak+	Detects positive peak signals by selecting the maximum peak value for each point from each bucket. This mode is useful for sinusoidal signals.

Peak-	Detects negative peak signals by selecting the lowest peak value for each point from each bucket. This mode is not recommended for amplitude measurement.
Sample	Randomly selects a value from the bucket sample. Useful for noise signals.
RMS Average	Calculates the RMS average power of all the samples in the sample bucket.
EMI> Quasi-peak	The quasi-peak detector is a peak detector that is weighted by the duration and repetition rate of the signal, as specified by the CISPR 16-1-1 standard. Quasi-peak detection is characterized by a fast charge time and slow decay time.
EMI> Average	Calculates the average power of all the samples in the sample bucket.

Auto Detector
Selection Method

Below is a flow chart diagram showing the Detector selection for the Auto mode.

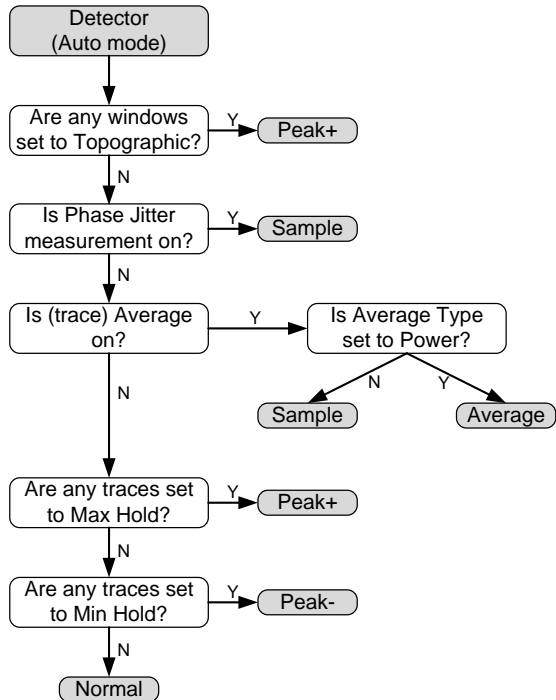

Operation

1. Press **Trace** > More[F7]>Detection[F2].
2. Select the trace detection mode for the selected trace:

Auto[F1]
Normal[F2]
Peak+[F3]
Peak-[F4]
Sample[F5]
RMS Average[F6]
EMI[F7]>*Quasi peak*[F1]
EMI[F7]>*Average*[F2]

3. The display will return to the Trace menu.

Display Icon



Normal



Peak+ icon

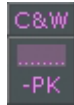

Peak- icon



Sample icon



RMS Average icon



Quasi-peak icon



Average icon

Trigger

The Trigger function sets the signal conditions upon which the spectrum analyzer triggers captured waveforms, including frequency, amplitude, and delay. An external trigger signal, instead of the default internal signal, may be used as required for special conditions.

The sections below can be used to skip to the relevant section:

- Free Run Mode → from page 85
- Activate Video Trigger → from page 85
- Activate External Trigger → from page 87
- Selecting Trigger Mode → from page 88
- Set the Trigger Delay Time → page 89

Selecting a Trigger Type



Free Run Mode

Description	In free run mode all signals are captured and the trigger conditions are not used.
-------------	--

Free Run Mode	1. Press  > <i>Free Run</i> [F1] to run in free mode.
---------------	--

Activate Video Trigger

Description	Sets the video trigger level for video signals. When the video signal voltage level exceeds* the video trigger level, a trigger signal will be generated. *for positive video edge
-------------	---

Parameters	<p>Video Edge: Determines the polarity of the video trigger.</p> <p>Positive: The signal voltage exceeds the video level at the trigger frequency.</p> <p>Negative: The signal voltage is lower than the video level at the trigger frequency.</p> <p>Video Level: The trigger voltage level.</p> <p>Trigger Frequency: Sets the frequency to start triggering</p>
Operation	<ol style="list-style-type: none"> 1. Press  > <i>Trigger Condition</i>[F2] > <i>Video</i>[F1] 2. Press <i>Video Edge</i>[F1] and choose the edge. <ul style="list-style-type: none"> Range: Positive, Negative 3. Press <i>Video Level</i>[F2] and set the video voltage trigger level. <ul style="list-style-type: none"> Trigger level: (-120dBm to +30dBm) +Ref Level Offset 4. Press <i>Trigger Freq</i>[F3] and choose the frequency at which the spectrum analyzer will check the triggering conditions. <ul style="list-style-type: none"> Frequency: 0-3.25GHz+frequency offset
Display Icon	 The Video Level trigger icon is displayed when the Video trigger is activated.



Note

Set the trigger back to Free Run to disable the video trigger.

Activate External Trigger

Description

The external trigger is used when an external trigger signal is input into the rear panel TRIG IN port. The external trigger signal can be configured as positive or negative edge.

Trigger: 3.3V, CMOS

Operation

1. Press  > *Trigger Condition[F2]* > *Ext.Edge[F2]* and select the trigger edge:

Pos: Positive edge
Neg: Negative edge

2. Connect the external trigger signal to the rear panel TRIG IN port.



3. Press *Action Now[F5]* to activate the external trigger.
4. The system will now wait for the trigger conditions to be matched before starting a sweep.

Display Icon



The EXT Trigger icon is displayed when the external trigger is activated.



Note

The trigger will revert back to the Free Run mode if any parameter settings are changed, such as the span or amplitude settings.

Selecting the Trigger Mode

Description	In free run mode all signals are captured and the trigger conditions are not used.								
Modes	Normal:	The spectrum analyzer captures every signal that meets the trigger conditions.							
	Single:	The spectrum analyzer captures the first signal that meets the trigger conditions.							
	Continuous:	The spectrum analyzer captures the first signal that meets the trigger conditions then switches to free run mode thereafter.							
Operation	<ol style="list-style-type: none"> Press  > <i>Trigger Mode[F3]</i> to toggle the trigger mode: <table data-bbox="369 989 778 1085"> <tr> <td>Nor.:</td> <td>Normal</td> </tr> <tr> <td>Sgl.:</td> <td>Single</td> </tr> <tr> <td>Cont.:</td> <td>Continuous</td> </tr> </table> Press <i>Action Now[F5]</i> to manually start triggering. 			Nor.:	Normal	Sgl.:	Single	Cont.:	Continuous
Nor.:	Normal								
Sgl.:	Single								
Cont.:	Continuous								

Display Icons

Normal:



Single:



Continuous:

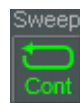

Set the Trigger Delay Time

Description Sets the delay time between when the analyzer triggers and when the analyzer begins to capture the signal.

Delay time range: 1ns to 1ks

Operation 1. Press  > *Trigger Delay[F4]* and set the trigger delay time.

Delay range: 0~1000s

Marker

A Marker shows the frequency and amplitude of a waveform point. The GSP-9330 can activate up to 6 markers or marker pairs simultaneously as well as up to 10 peak markers in the marker table.

The marker table helps editing and viewing multiple markers in a single display.

A delta marker shows the frequency and amplitude difference from a reference marker.

The GSP-9330 can automatically move a marker to various locations including the peak signal, center frequency, and start/stop frequency. Other marker operations regarding signal peaks are available in the Peak Search function.

- Activating a Marker → from page 91
- Move Marker Manually → from page 92
- Move Marker to Preset Locations → from page 92
- Activate Delta Marker → from page 93
- Move Delta Marker(s)Manually → from page 94
- Marker Functions → from page 95
- Move Marker to Trace→ from page 98
- Show Markers in Table → from page 99
- Peak Search → from page 100
- Peak Configuration → from page 103
- Peak Table → from page 104

Activating a Marker

There are two basic marker types, normal markers and delta markers. Normal markers are used to measure the frequency/time or amplitude of a point on the trace. Delta markers are used to measure the difference between a reference point and a selected point on the trace.

Activate a Normal Marker

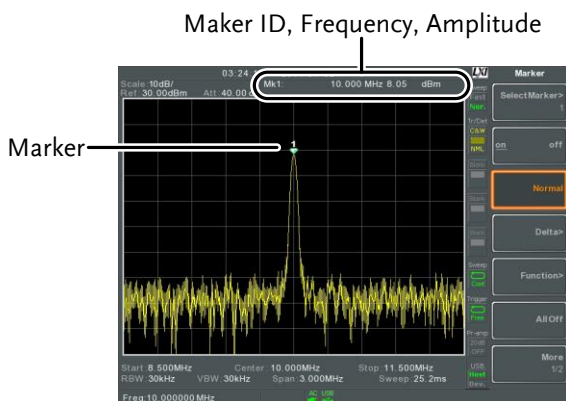

Operation

1. Press **Marker** > *Select Marker*[F1] and select a marker number.
Marker: 1~6
2. Press [F2] to turn the selected marker on.
3. Press *Normal*[F3] to set the selected marker to the Normal type.
4. The display will show the marker on the trace (centered by default) with the marker measurement at the top of the display.



Move Marker Manually

Operation

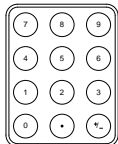
1. Press  > *Select Marker[F1]* and select a marker number.
2. Use the left/right arrow keys to move the marker one grid division. 
3. Use the scroll wheel to move the marker in fine increments. 
4. Alternatively, the numeric keypad in combination with the F1~ F7 keys can be used to directly enter the frequency of the marker position. 

Move Marker to Preset Locations

Description

The  key is used to move the selected marker to a number of preset positions.



Functions

- Mkr>Center: Move to center frequency.
- Mkr>Start: Move to start frequency.
- Mkr>Stop: Move to stop frequency.
- Mkr>CF Step: Move to step frequency.
- Mkr>Ref Lvl: Move to reference level amplitude.



Note

When the  key is used, the span and other settings may be automatically changed.

- Operation
1. Press  > *Select Marker[F1]* and select a marker number.
 2. Press  and select a marker position:
 - Mkr>Center[F1]*
 - Mkr>Start [F2]*
 - Mkr>Stop[F3]*
 - Mkr>CF Step[F4]*
 - Mkr>Ref Lv[F5]*

Activate Delta Marker

Description Delta markers are marker pairs that measure the difference in frequency/time and amplitude between a reference marker and a delta marker.

When delta markers are activated, the reference and delta marker appear at the position of the selected marker, or in the center of the display if the selected marker has not yet be activated.

The marker measurement is located at the top of the display, under the “normal marker” measurement.

Delta Markers	Ref:	Reference marker, designated as $\nabla 1$.
	Delta:	Delta marker, designated as $\Delta 1$.

- Operation
1. Press  > *Select Marker[F1]* and select a marker number.
 2. Press *[F2]* to turn the selected marker on.
 3. Press *Delta[F4]>Delta[F1]* to set the selected marker to the Delta type.

Move Delta Marker(s) Manually

- Move Delta or Reference Marker
1. Press $\text{Marker} > \Delta[F4] > \text{MoveRef}[F2]$ to move the reference marker.
 2. Press $\text{Marker} > \Delta[F4] > \text{MoveDelta}[F3]$ to move the Delta marker.
 3. Move the selected marker in the same fashion as a normal marker, see page 92
-

- Move Both reference and delta marker
1. Press either *Move Pair Span*[F4] or *Move Pair Center*[F5] to move both markers at the same time.

Move Pair Span: Sets the frequency span between both markers. The span can be positive or negative:

$$\frac{1}{\nabla} \leftarrow +\text{span} \rightarrow \frac{\Delta 1}{\nabla}$$

$$\frac{\Delta 1}{\nabla} \leftarrow -\text{span} \rightarrow \frac{1}{\nabla}$$

Move Pair Center: Moves both markers at the same time, keeping the span between both markers even throughout.

2. Move both markers in the same fashion as a normal marker, see page 92.

Marker Functions

Marker Noise

Description The noise marker function calculates the average noise level over a bandwidth of 1Hz, referenced from the marker position.

- Operation**
1. Press **Marker** > *Select Marker[F1]* and select a marker number.
 2. Press **[F2]** to turn the selected marker on.
 3. Press *Normal[F3]* and then position the marker to the desired location.
 4. Press *Function[F5]>Marker Noise* and turn Marker Noise on.
 5. The display will show the noise level measurement at the top of the screen in dBm/Hz.

Marker ID, Frequency, dBm/Hz



Marker

Frequency Counter

Description The frequency counter function is used to make accurate frequency measurements.

- Operation**
1. Press **Marker** > *Select Marker[F1]* and select a marker number.
 2. Press *[F2]* to turn the selected marker on.
 3. Press *Normal[F3]* and then position the marker to the desired location.
 4. Press *Function[F5]>Frequency Counter[F1]* and turn the counter function on.
 5. Press *Resolution[F2]* and set the resolution:

Auto:	Automatically chooses the best resolution.
Man:	Allows the resolution to be manually set.
Man Range:	1Hz, 10Hz, 100Hz, 1kHz
 6. The display will show the frequency measurement at the top of the screen at the selected resolution.

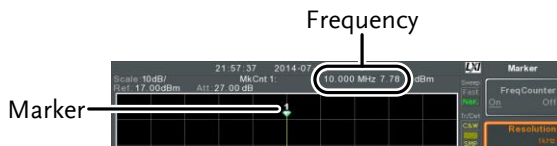

VSWR

Description The Voltage Standing Wave Ratio is the voltage ratio between transmitted and reflected waves, usually measured in RF electrical transmission systems. The VSWR function will use the Tracking Generator of the GSP-9330 as reference signal. See page 234 for more information about the Tracking Generator.

- Operation**
1. Before starting a VSWR measurement, the tracking generator must be turned on and normalized. If the TG has not been turned on and normalized, the VSWR function will not be available.
 2. Connect the TG output directly to the RF input.
 3. Press  >Tracking Generator[F1]>TG[F1] to toggle the tracking generator to on.
 4. Press *Normalize*[F6]>*Exe. Norm*[F1] to perform a normalization.
 5. Using a Return Loss Bridge (recommended Goodwill Instek RLB-001), connect the DUT to the TG output and the RF input of the GSP-9330 as shown in the below diagram.

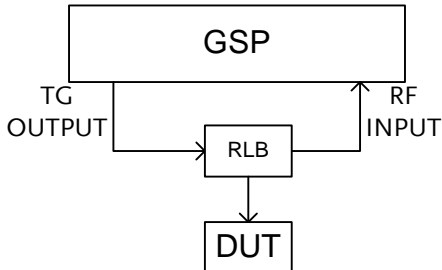

6. Press **Marker** > *Select Marker*[F1] and select a marker number.
7. Press [F2] to turn the selected marker on.
8. Press *Function*[F5]>*VSWR*[F3] to turn the VSWR measurement on.
9. The display will show the VSWR measurement at the top of the screen.

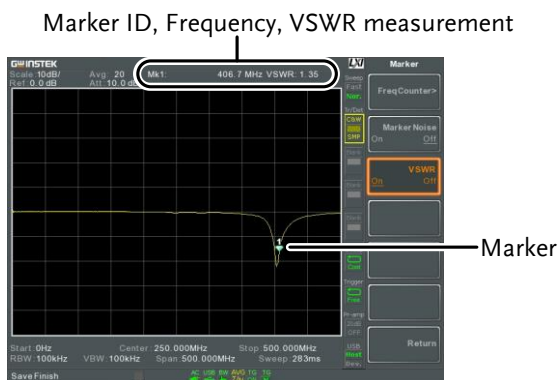

Move Marker to Trace

Description The Marker Trace function moves the selected marker to any of the currently active traces.

- Operation**
1. Press **Marker** > *Select Marker*[F1] and select a marker number.
 2. Press [F2] to turn the selected marker on.
 3. Press *More*[F7]>*Marker Trace*[F1] and choose a trace to move the current marker to. Only active traces can be selected.

- Auto[F1]*
- Trace1[F2]*
- Trace2[F3]*
- Trace3[F4]*
- Trace4[F5]*

4. In the example below, marker 1 is set to Trace1 and marker 2 is set to Trace2.

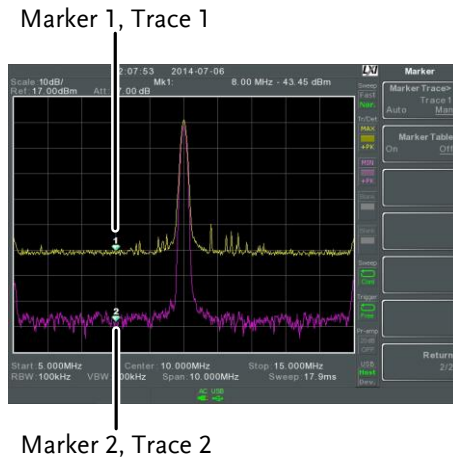

Show Markers in Table

Description	The GSP-9330 has a Marker Table function to show all the active markers and measurements at once.
Operation	<ol style="list-style-type: none"> 1. Press Marker > More[F7] > Marker Table[F2] and turn the marker table on. 2. The display will split into two screens. The bottom half will show the Marker Table with the marker ID(normal, reference or delta), trace, x-axis position (frequency/time) and the amplitude of the marker.



Marker Table



Peak Search

Move Marker to Peak

Description	The Peak Search key is used to find trace peaks.
Operation	<ol style="list-style-type: none"> Press Marker > <i>Select Marker[F1]</i> and select a marker number. Press Peak Search > <i>Peak Search[F1]</i>. The marker will move to the highest signal peak. To continually search for the peak on each sweep, press, Peak Search > <i>More [F7]</i> > <i>Peak Track[F1]</i> and set <i>Peak Track</i> to on.

Move Marker and Peak to Center

Description The Center function moves the marker to the highest signal peak and moves the center frequency to that peak. This function can be used with the *Next Peak*, *Next Peak Right*, *Next Peak Left* and *Min Search* peak functions, see the *Search for Peaks* section on page 101 for details.

- Operation**
1. Press  > *Select Marker*[F1] and select a marker number.
 2. Press  > *Mkr* > *Center*[F2].
-





Note

The span will not be changed.

Search for Peaks

Description The  key can be used to search for a number of different peaks.

Peak Search	Next Peak:	Searches for next highest peak visible on the display.
	Next Peak Right:	Searches for the next peak to the right of the marker.
	Next Peak Left:	Searches for the next peak to the left of the marker.
	Min Search:	Searches for the lowest peak.

- Operation**
1. Press  > *Select Marker*[F1] and select a marker number.
 2. Press  and select the type of peak you wish to find.
-

Example:
Next Peak

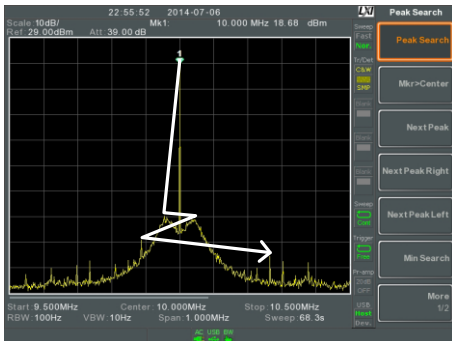

Example:
Next Peak Right

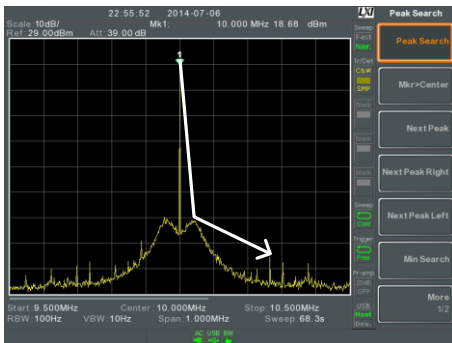

Example:
Next Peak Left

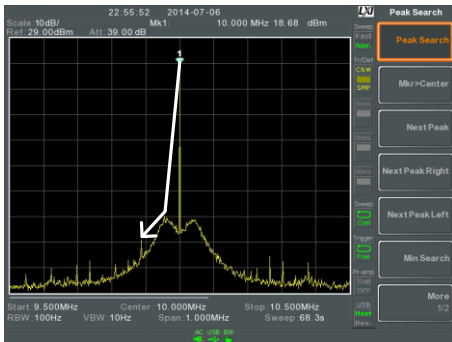

Peak Configuration

Description

There are two peak search configuration options: Peak Excursion and Peak Threshold.

Peak Excursion: Peak Excursion sets the minimum value above the peak threshold for which peaks will be detected.

Peak Threshold: Peak threshold sets the minimum threshold level for the analyzer to detect peaks. Any value above the Peak Threshold + Peak Excursion will be detected as a peak.

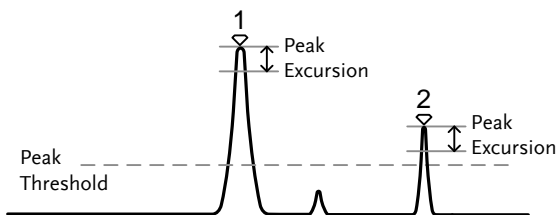

Operation

1. Press  > More [F7].
2. Press *Peak Excursion*[F2] to set the excursion level.
3. Press *Peak Threshold*[F3] to set the peak threshold.

Peak Excursion: 0~100dB

Peak Threshold: -120dB~+30dB

Peak Table

Description The Peak Table function will display all peaks (up to 10) that meet the peak configuration settings. The amplitude and frequency for each peak is listed.

- Operation**
1. Press  >More[F7]>Peak Table[F5].
 2. Press *Peak Sort*[F2] and set the sorting type:
 - Freq: Sort by frequency in ascending order.
 - Amp: Sort by amplitude in ascending order.
 3. Press *Peak Table*[F1] to turn the peak table on.
 4. The display splits in two. The bottom screen shows the peak table with the peak marker ID, X-axis position and amplitude.

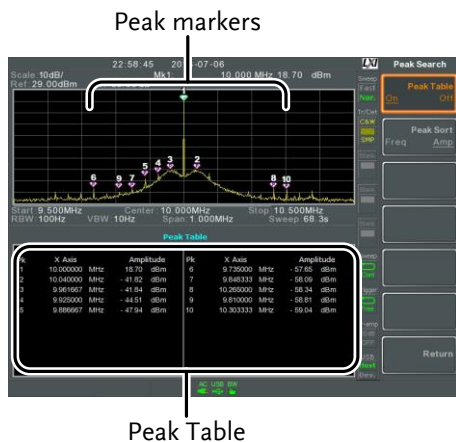



Note

Note all that the markers for the Peak Table function are all marked with “P” and are colored purple so they can be distinguished from the other markers.

Display

The Display key configures the basic display settings as well as setting up the display mode (spectrum, spectrographic, topographic) and the split screen modes.

Adjusting the LCD Brightness

Description	The LCD brightness levels can be adjusted to three pre-set levels.						
Operation	<ol style="list-style-type: none">1. Press  > <i>LCD Brightness[F2]</i> to toggle the display brightness: <table><tr><td>Hi:</td><td>High brightness</td></tr><tr><td>Mid:</td><td>Medium brightness</td></tr><tr><td>Lo:</td><td>Low brightness</td></tr></table>	Hi:	High brightness	Mid:	Medium brightness	Lo:	Low brightness
Hi:	High brightness						
Mid:	Medium brightness						
Lo:	Low brightness						

Turning the LCD Backlight Off

Description	The LCD backlight can be turned off to preserve power or to prolong the lifetime of the LCD display when not in use.
Operation	<ol style="list-style-type: none">1. Press  > <i>LCD Backlight[F3]</i> and turn the LCD backlight off.2. When the backlight is off, press any function key to turn the LCD backlight back on.

Setting a Display Line (Reference Level Line)

Description The Display Line function is used to superimpose a reference level line over the traces.

- Operation**
1. Press **Display** > *Display Line*[F4] to turn the display line on.
 2. Set the display line level and unit.

Example:

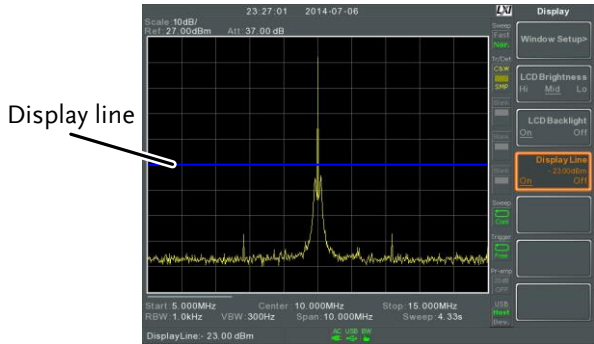

Display line set at -50dBm

Using the Video Out Port

Description The GSP-9330 has a dedicated DVI terminal to output the display to an external monitor. The video output is always on.

Output resolution 800 x 600 (fixed)

- Operation**
1. Connect an external monitor to the rear panel DVI terminal.

DVI - I

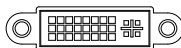

Setting the Display Mode

Description The GSP-9330 has three different display modes for viewing: spectrum, spectrograph and topographic. It is also possible to view the spectrum with the spectrographic or topographic views using a split screen.

Spectrum	Default display mode.
Spectrogram	Useful for viewing frequency or power in the time domain.
Topographic	Useful for observing the frequency of events with a trace.

Operation 1. Press  > *Window Setup*[F1] and select the display mode:

Spectrum[F1]:

Spectrogram[F3]:

Topographic[F4]:

Spectrogram+Spectrum[F5]:

Topographic+Spectrum[F6]:



Note

The same trace is used on the top and bottom for the Spectrogram+Spectrum and Topographic+Spectrum modes.

Example:
Spectrogram



The Spectrogram view shows signals in both the frequency and time domain. The X-axis represents frequency, the Y-axis represents time and the color of each point represents the amplitude at a particular frequency & time (Red = high → dark blue = low).

Each new trace is shown at the bottom of the display and older traces are pushed up toward the top of the display until they are removed

Topographic

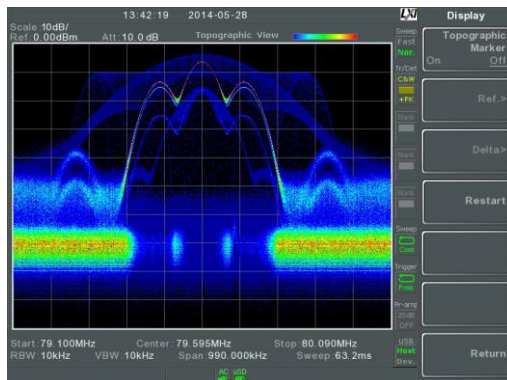

The topographic view shows the frequency of events. The topographic view is useful for observing smaller signals that have been overpowered by stronger signals or to easily observe intermittent events. Color is used to represent the frequency of an event. Red represents a high frequency of occurrence, while blue represents events that occur rarely.

Spectrogram + Spectrum

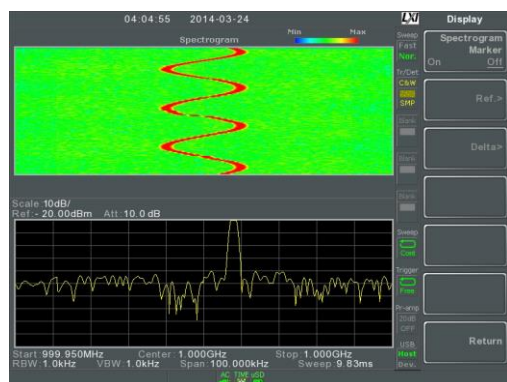

Displays both spectrographic and spectrum views of the signal.

Topographic
+Spectrum

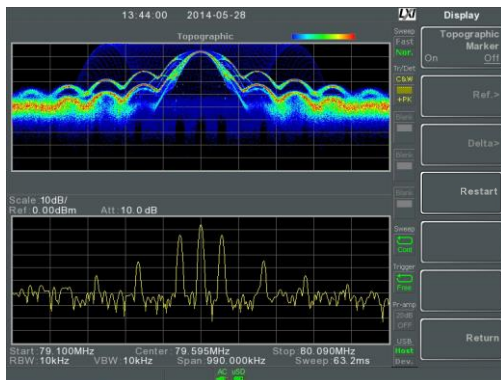

Displays both topographic and spectrum views of the signal.

Spectrogram and Topographic Markers

Description The Spectrogram and Topographic display view can also use markers and delta markers to mark the frequency and amplitude of points of interest. This function is particularly useful as it allows you to make delta measurements both in the frequency and time domain.

- Operation**
1. When in the Topographic view (single or split screen), press *Topographic Marker* and turn on.
 2. When in the Spectrographic view (single or split screen), press *Spectrogram Marker* and turn on.
 3. To set the reference marker, press *Ref.[F2]>X Axis[F1]* and set x-axis position (frequency).
 4. Press *Y Axis[F2]* and the set the y-axis position (amplitude).

The frequency and amplitude information will be displayed on the remaining function keys:

<i>Frequency[F3]</i>	Marker frequency
<i>Amplitude[F4]</i>	Marker Amplitude.
<i>Time[F4]</i>	Time relative to the start of the sweep.

5. To set the delta marker, press *Return[F7]* *>Delta[F3]>X Axis[F1]* and set the x-axis position of the delta marker (frequency).
6. Press *Y Axis[F2]* to set the y-axis position of the delta marker (amplitude).

The frequency and amplitude delta will be displayed on the remaining function keys:

Δ <i>Frequency[F3]</i>	Position of the delta marker.
Δ <i>Amplitude[F4]</i>	Amplitude of the delta marker.
Δ <i>Time[F4]</i>	Time delta
$1/\Delta$ <i>Time[F5]</i>	Frequency delta

Example

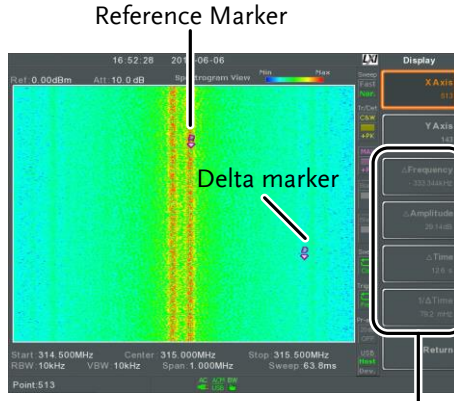

Ref. marker and Delta marker positions/measurements

Spectrogram view is shown as an example.

Split Spectrum View

Description The split spectrum view is able to view two different sweep ranges on the display at the same time using a split screen view. The top and bottom view can have independent sweep ranges, amplitudes, spans and other settings. However only one split screen (top or bottom) can be swept each time.

- Operation**
1. Press **Display** > *Window Setup*[F1] > *Split Spectrum*[F2] > *Active Win*[F1] to activate the upper split screen.
 2. Pressing *Active Win*. [F1] will toggle the sweep between the upper and lower screen.
 3. Press *Alternate Sweep*[F2] for the analyzer to alternate the sweep between the upper and lower screen at the end of each sweep.



Note

No operations can be performed in alternate sweep mode.

After exiting the split spectrum view, the analyzer will use the settings from the active window. The settings for the inactive screen will be retained for the next time that split spectrum view is used.

Example:

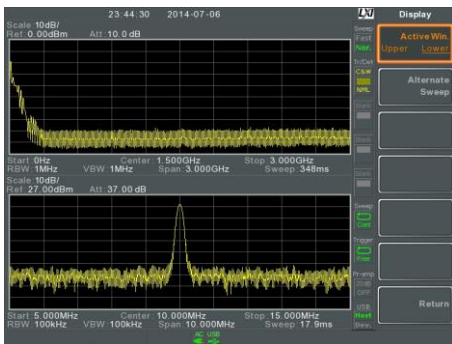

System Settings

System Information

Description The System Information displays the following:

Serial Number	Installed Options
Version:	Calibration Date:
Software	LOI
Firmware	RF
File sys	TG
RF	DNS Hostname
TG	MAC Address
DSP	LXI Password
Wordlist	
Core	

Operation 1. Press  > *System Information*[F1] to bring up a list of the system information.

Error Messages

Description You can view error messages that are in the error queue by message number, description and time. All errors from the system error queue are logged when operating the analyzer. For a list of the error messages, please see the programming manual.

Operation 1. Press  > *Error message*[F2] to bring up the error message table.

2. Press *Prev Page*[F2] and *Next Page*[F3] to navigate through each page of the error list.

3. Press *Clear Error Queue*[F6] to clear the error messages from the list.

Set the System Language

Description The GSP-9330 supports a number of languages. The system language sets the soft menu keys to the selected language.

Operation 1. Press  > *Language*[F3] and choose the system language.

Set the Date and Time

- Operation**
1. Press  > *Date/Time*[F4].
 2. Press *Set Date*[F1] to set the date:

<i>Year</i> [F1]	Sets the year.
<i>Month</i> [F2]	Sets the month.
<i>Day</i> [F3]	Sets the day.
 3. Press *Set Time*[F2] to set the system time:

<i>Hour</i> [F1]	Sets the hour (24hr).
<i>Minute</i> [F2]	Sets the minute.
<i>Second</i> [F3]	Sets the second.
 4. The system time and date will be shown at the top of the display.

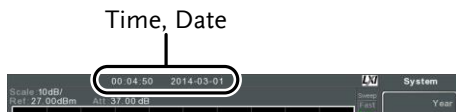

Display the Date and Time on the Screen

Description Enables or disables the date and time on the screen.

Operation 1. Press  > *Date/Time*[F4] > *Clock*[F4] and turn the clock display on or off.

Using the Wake-Up Clock

Description The GSP-9330 has a wake-up clock to allow the spectrum analyzer to automatically turn on at a set time.

Operation 1. Press  > *Date/Time*[F4] > *Wake-Up Clock*[F3] and set the following parameters:

Select Clock[F1] Choose a wake-up clock (1~7).

State[F2] Turns the selected clock on/off.

Hour[F3] Set the wake-up hour

Minute[F4] Set the wake-up minute.

Repeat Single[F5] Set the wake-up clock to repeat or single.



Only single days can be configured for the wake-up clock.

Alarm Output

Description Allows the pass/fail output to be output via the ALARM OUT port.

Output: Open collector

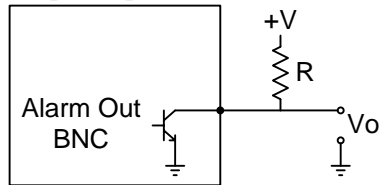

Operation



1. Press System > *Alarm Output*[F6] and toggle the ALARM OUT port on or off.

Preset

The Preset function loads either factory default states or the user-defined states – depending on the Preset configuration settings.

- Using the Preset Key → from page 119
- Save the User Preset Settings → from page 119
- Preset Type Settings → from page 120
- Power on Preset Settings → from page 120

Using the Preset Key

Description	The  key loads the factory default state or user-defined preset settings. See the Preset Type Settings on page 119 to set the type of preset settings that are loaded.
Factory Preset	The factory default settings are listed on page 285.
Operation	Press  to load the preset settings.

Save the User Preset Settings

Description	The user-defined preset settings can be created by saving the current state as the user-defined preset settings.
Operation	Press  >Pwr On/Preset[F5]>Save User Preset[F3] to save the current state as the User Preset settings.

Preset Type Settings

Description Each time the  key is pressed, a set of preset configuration settings are loaded. The preset configuration settings can be either the factory default settings or the user-defined settings.

Operation

- Press  > *Pwr On/Preset[F5]* > *Preset Type[2]* and choose the preset type:
User Preset[F1]
Factory Preset[F2]

Power on Preset Settings

Description When the spectrum analyzer is turned on, either the preset configuration settings are loaded (default) or the configuration settings that were used before the instrument was turned off.

Operation

- Press  > *Pwr On/Preset[F5]* > *Power On[F1]* and choose the power on settings:
Power On: **Last, Preset**

 **Note**

See Preset Type Settings on page 285 for details on the preset conditions.

The last preset conditions cannot be loaded if the instrument was not powered down correctly the last time it was used. Please see page 29 for details.

ADVANCED OPERATION

Measurement	123
Channel Analysis Overview	123
ACPR	125
OCBW	128
AM/FM Analysis	129
AM Analysis	129
AM Pass Fail Testing	133
FM Analysis	135
FM Pass Fail Testing	139
AM/FM Demodulation	140
ASK Measurement	141
ASK Pass Fail Testing	147
FSK Measurement	148
FSK Pass Fail Testing	154
2FSK Measurement	155
2FSK Pass Fail Testing	157
Phase Jitter Measurement	159
Spectrum Emission Mask Overview	161
Spectrum Emission Mask Testing	173
Third Order Intermodulation Distortion (TOI)	179
CNR/CSO/CTB Measurement	181
Carrier to Noise Ratio (CNR)	181
Composite Second Order (CSO)	184
Composite Triple Beat (CTB)	185
Harmonic Measurements	187
N dB Bandwidth	190
P1dB Measurement	191
P1dB Normalization	195
IQ Analysis	198
EMC Pre-Compliance Testing	201
EMI Test	202
Near Field Testing ~ Field Sensor	210
Near Field Testing ~ Source Contact Probe	213
AC Voltage Probe	216
EMS Test	219

Limit Line Testing.....	222
Creating a Limit (Point by Point).....	222
Creating a Limit (from Trace Data).....	224
Creating a Limit (from marker data).....	225
Delete Limit Line.....	226
Pass Fail Testing.....	227
Sequence.....	229
Editing a Sequence.....	229
Running a Sequence.....	233
Tracking Generator.....	234
Activate Tracking Generator.....	234
Normalize the Tracking Generator.....	235
Power Meter.....	239
Activating Power Meter Mode.....	239
Data Logging Power Meter Measurements.....	241
Demo Kit.....	244
Amplitude Shift Keying.....	244
Frequency Shift Keying.....	246

Measurement

This section describes how to use the automatic measurement modes. The GSP-9330 includes the following measurements:

- ACPR → from page 125
- OCBW → from page 128
- AM Analysis → from page 129
- FM Analysis → from page 135
- AM/FM Demodulation → from page 140
- ASK Measurement → from page 141
- FSK Measurement → from page 148
- 2FSK Measurement → from page 155
- Phase Jitter → page 159
- SEM measurement → from page 161
- TOI measurement → from page 179
- CNR/CSO/CTB measurement → from page 181
- Harmonic Measurement → from page 187
- N dB measurement → from page 190
- P1dB Measurement → from page 191
- IQ Analysis → from page 198

Channel Analysis Overview

Description	Channel analysis measurement includes ACPR (adjacent channel power) and OCBW (occupied bandwidth) measurements.
-------------	---

Parameters	Channel bandwidth	The frequency bandwidth the target channel occupies. Range: Between 0Hz~3.25GHz (0Hz excepted)
	Channel Space	The frequency distance between each main channel. Range: Between 0Hz~3.25GHz
	Adjacent channel bandwidth 1 & 2	The frequency bandwidth the adjacent channels occupy. Range: Between 0Hz~3.25GHz (0Hz excepted)
	Adjacent channel offset 1 ~ 3	The frequency distance between the adjacent channels and main channel. Range: 1 Between 0Hz~3.25GHz (0Hz excepted)
	OCBW%	The ratio of occupied bandwidth to the amount of power consumed. Range: 0% to 100%, 0.1% resolution.

ACPR

Description Adjacent channel power refers to the amount of power leaked to the adjacent channel from the main channel. This measurement is a ratio of the main channel power to power in the adjacent channel.

Example

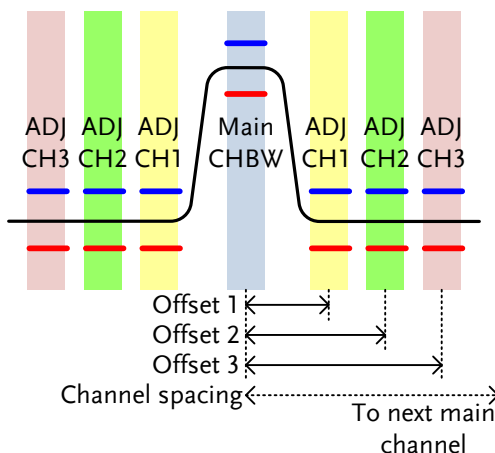

Operation:
Setting up the main channel

1. Press **Measure** > *Channel Analysis*[F1]>*ACPR*[F2] and turn ACPR on.
 - *Any other measurement mode will automatically be disabled.*
2. The display splits into two screens. The top screen shows the main channel, adjacent channels and their corresponding limits. The bottom screen shows the ACPR measurement results in real time.

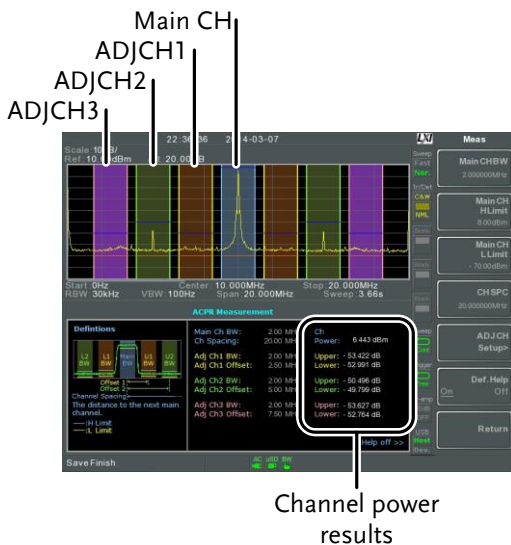

3. Press **Measure** > *Channel Analysis*[F1]>*ACPR Setup*[F1]> and set the following:

- Main CHBW*[F1] Set the bandwidth of the main channel.
- Main CH H Limit*[F2] Set the low limit for the main channel.
- Main CH Limit*[F3] Set the high limit for the main channel
- CH SPC*[F4] Specify the channel spacing

Operation:
Setting up the adjacent channel(s)

1. Press *ADJCH Setup*[F5] to setup the adjacent channels:
 - Select AdjCh*[F1] Choose an adjacent channel number: 1, 2, 3
 - [F2] Toggle the selected channel on/off.

<i>ADJCHBW[F3]</i>	Choose the bandwidth of the selected channel.
<i>ADJCH Offset[F4]</i>	Set the adjacent channel offset.
<i>ADJCH HLimit[F5]</i>	Set the adjacent channel high limit.
<i>ADJCH LLimit[F5]</i>	Set the adjacent channel low limit.

2. Repeat the above steps for the other adjacent channels, if needed.

Move Channels
Up/Down

1. Press  > *Channel Analysis[F1]* and press the following to move to another channel:
 - Channel Move Up[F5]* Next main channel.
 - Channel Move Down[F6]* Previous main channel.



The channel space (CH SPC) parameter determines where the next main channel is located.

Remove
Definitions Help

1. Press  > *Channel Analysis[F1]* > *ACPR Setup[F1]* > *Def. Help* to toggle the *Definitions Help* on or off.

OCBW

Description Occupied bandwidth measurements are used to measure the power of the occupied channel as a percentage to the power of the channel.

Example

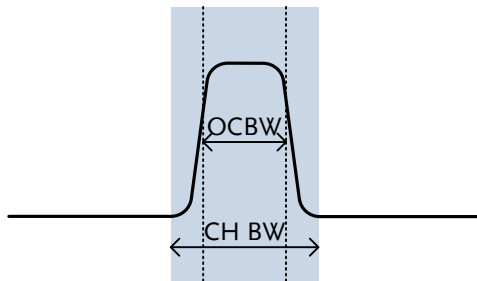

Operation:
Setting up the main channel

1. Press **Measure** > *Channel Analysis*[F1]>*OCBW*[F4] and turn OCBW on.
 - Any other measurement mode will automatically be disabled.
2. The display splits into two screens. The top shows the channel bandwidth. The bottom screen shows the OCBW measurement results in real time.

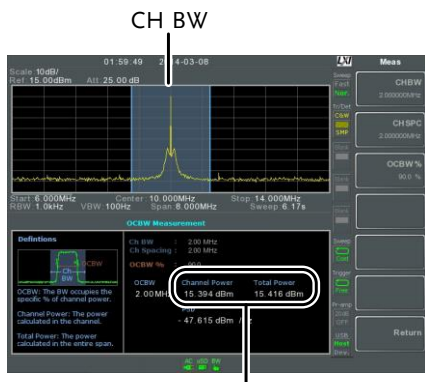

Channel power and total power results

3. Press *OCBW Setup*[F3] to enter the OCBW setup:

<i>CHBW</i> [F1]	Set the channel bandwidth.
<i>CH SPC</i> [F2]	Set the channel space between main channels.
<i>OCBW%</i> [F3]	Set the % of the OCBW to CHBW.

Move Channels Up/Down

1. Press  > *Channel Analysis*[F1] and select:
 - Channel Move Up*[F5] Next main channel.
 - Channel Move Down*[F6] Previous main channel.



Note

The channel space (CH SPC) parameter determines where the next main channel is located.

The CH SPC parameters from the ACPR and OCBW setups are independent.

AM/FM Analysis

AM Analysis

Description	When amplitude modulation is turned on, the input signal is centered on the center frequency and the span is automatically set to zero-span.	
Measurement items	AM Depth:	Current, Min, Cent, Max
	Mod. Rate:	Current, Min, Cent, Max
	Carrier Pwr:	Current, Min, Cent, Max
	Carrier Freq Offset:	Current, Min, Cent, Max

SINAD: Current, Min, Cent, Max

Operation:
configuration

1. Set the center frequency to the carrier frequency (page 41).
2. Press **Measure** > *Demod[F2]>AM Analysis[F1]>AM Analysis[F1]* and turn AM analysis on.
 - *Any other measurement mode will automatically be disabled.*
3. The display splits into two screens. The top shows the AM waveform in the time domain. The bottom screen shows the AM measurement.

AM waveform

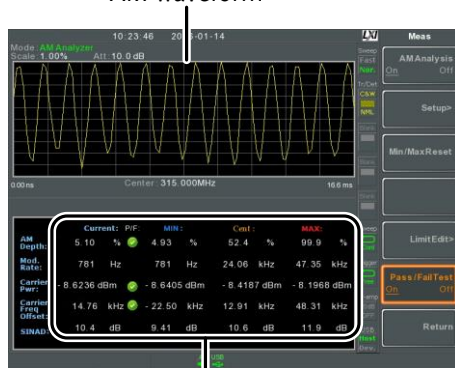

AM modulation
measurements

4. Press *Setup[F2]>IF Bandwidth[F1]* and set the Intermediate frequency bandwidth.
 - *Set with adequate bandwidth to accommodate spectrum contained in the carrier.*

5. Press *LPF[F2]* to set the low pass filter frequency, alternatively the frequency can be set to bypass:

AM Signal Frequency (Hz)

Selectable bandwidth of LPF (Hz)

≥78,125 156,250 78,125 52,083 39,063 31,250

≥39,063 78,125 39,063 26,042 19,531 15,625

≥19,531 39,063 19,531 13,021 9,766 7,813

≥7,813 15,625 7,813 5,208 3,906 3,125

≥3,906 7,813 3,906 2,604 1,953 1,563

≥1,953 3,906 1,953 1,302 977 781

≥781 1,563 781 521 391 313

≥391 781 391 260 195 156

≥195 391 195 130 98 78

≥78 156 78 52 39 31

≥39 78 39 26 20 16

≥20 39 20 13 10 8

≥8 16 8 5 4 3

6. Press *Time Axis [F3]* to set horizontal axis parameters:

Ref. Value[F1] Sets the starting time on the time axis.

Ref. Pos[F2] Shifts the waveform X number of grid subdivisions.

- Scale/Div[F3]* Sets the grid division scale when Auto Scale is Off.
- Auto Scale[F4]* Toggles auto-scaling on/off.

7. Press *Depth Axis[F4]* to set depth (vertical) parameters:

- Ref.Value[F1]* Offsets the reference position as a percentage of the vertical scale/div.
- Ref.Pos[F2]* Sets the reference position of the waveform on a vertical grid subdivision (1:10).
- Scale/Div[F3]* Sets the vertical grid division scale when Auto Scale is Off.
- Auto Scale[F4]* Toggles auto-scaling execution.

8. Press *Squelch[F6]* to set carrier squelch level. The squelch setting will suppress unwanted noise of a certain level.

Operation:
trigger
configuration

9. Press *AF Trigger[F5]>Trigger Setup[F2]* to set the triggering conditions:

- Edge Slope[F1]* Sets the trigger to rising or falling edge.
- Trigger Mode[F2]* Sets the triggering mode:
Nor.: Normal trigger
Sgl.: Single trigger
Cont.: Continuously trigger

Trigger Level[F3] Sets the trigger level as a percentage of the depth. (The displayed level will only remain for a few moments)

Trigger Delay[F4] Sets the trigger delay time:
0 to 1ks

10. Press *Return[F7]* to return to the AF Trigger menu and to set the remaining trigger options:

FreeRun[F1] Disables the trigger, this is the default setting.

Start Time[F3] Sets the start time for the x-axis for the AM waveform in the top-half of the screen.

Stop Time[F4] Sets the stop time for the x-axis for the AM waveform in the top-half of the screen.

Action Now[F5] Turns FreeRun mode off and uses the user-defined trigger settings.



Note

The MAX and MIN measurements are held until higher or lower values are found. To reset the MAX and MIN measurements, press  *Demod[F2]>AM Analysis[F1]>Min/Max Reset[F3]*.

AM Pass Fail Testing

Description The Limit Edit function puts a pass limit on the AM depth, carrier offset and carrier power.

Measurement AM Depth: 5% ~ 95%

Range	<i>Carr. Offset:</i>	1Hz ~ 400kHz
	<i>Carrier Power:</i>	-120dBm ~ 30dBm

Operation:
configuration

- Press **Measure** > *Demod[F2]>AM Analysis[F1]>Limit Edit[F5]* and set the limits.

<i>AM Depth[F1]</i>	If the measured depth is above this limit, it will be judged as Fail.
<i>Carr. Offset[F2]</i>	If the measured carrier offset is above this limit, it will be judged as Fail.
<i>Carr. Power[F3]</i>	If the measured carrier power is above this limit, it will be judged as Fail.
- Press *Pass/Fail Test* and turn Pass/Fail on.
- The AM Measurement area in the bottom half of the screen will now include Pass/Fail indicators for the AM depth, carrier offset and carrier power.

Pass: 

Fail: 

Example

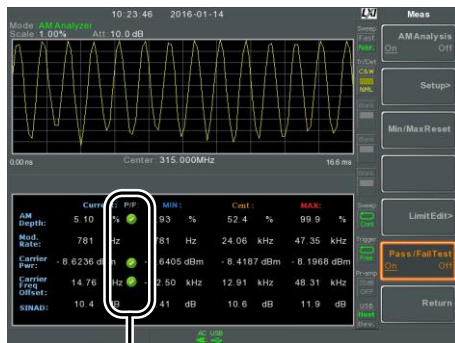

Pass/Fail judgments

FM Analysis

Description	When frequency modulation is turned on, the input signal is centered on the carrier frequency and the span is automatically set to zero-span.
-------------	---

Measurement items	Freq. Deviation:	Current, Min, Cent, Max
	Mod. Rate:	Current, Min, Cent, Max
	Carrier Pwr:	Current, Min, Cent, Max
	Carrier Freq Offset:	Current, Min, Cent, Max
	SINAD:	Current, Min, Cent, Max

- Operation: configuration
1. Set the center frequency to the carrier frequency (page 41).
 2. Press  > Demod[F2]>FM Analysis[F2]>FM Analysis[F1] and turn FM analysis on.
 - Any other measurement mode will automatically be disabled.
 3. The display splits into two screens. The top shows the FM waveform in the time domain. The bottom screen shows the FM measurement.

FM waveform

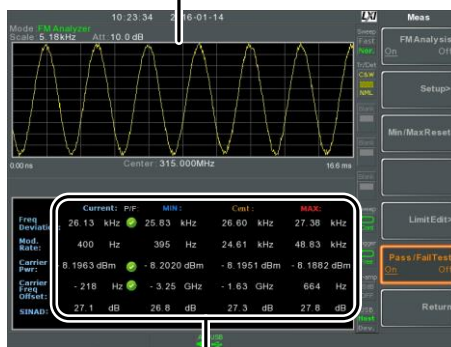

FM modulation measurements

4. Press *Setup*[F2]>*IF Bandwidth*[F1] and set the Intermediate frequency bandwidth. (10kHz, 30kHz, 100kHz, 300kHz, 1MHz,)
 - *Set with adequate bandwidth to accommodate spectrum contained in the carrier.*
5. Press *LPF*[F2] to set the low pass filter frequency, alternatively the frequency can be set to bypass:

FM Signal Frequency (Hz)	Selectable bandwidth of LPF (Hz)				
≥78,125	156,250	78,125	52,083	39,063	31,250
≥39,063	78,125	39,063	26,042	19,531	15,625
≥19,531	39,063	19,531	13,021	9,766	7,813
≥7,813	15,625	7,813	5,208	3,906	3,125
≥3,906	7,813	3,906	2,604	1,953	1,563
≥1,953	3,906	1,953	1,302	977	781
≥781	1,563	781	521	391	313

≥391	781	391	260	195	156
≥195	391	195	130	98	78
≥78	156	78	52	39	31
≥39	78	39	26	20	16
≥20	39	20	13	10	8
≥8	16	8	5	4	3

6. Press *Time Axis*[F3] to set horizontal axis parameters:

<i>Ref. Value</i> [F1]	Sets the starting time on the time axis.
<i>Ref. Pos</i> [F2]	Shifts the waveform X number of grid subdivisions.
<i>Scale/Div</i> [F3]	Sets the grid division scale when Auto Scale is Off.
<i>Auto Scale</i> [F4]	Toggles auto-scaling on/off.

7. Press *Deviation Axis*[F4] to set deviation (vertical) parameters:

<i>Ref. Value</i> [F1]	Offsets the reference position (in frequency).
<i>Ref. Pos</i> [F2]	Sets the reference position of the waveform on a vertical grid subdivision (1:10).
<i>Scale/Div</i> [F3]	Sets the vertical grid division scale.
<i>Auto Scale</i> [F4]	Toggles auto-scaling execution.

Operation:
trigger
configuration

8. Press *AF Trigger*[F5]>*Trigger Setup*[F2] to set the triggering conditions:

<i>Edge Slope</i> [F1]	Sets the trigger to rising or falling edge.
<i>Trigger Mode</i> [F2]	Sets the triggering mode: Norm.: Normal trigger Sgl.: Single trigger Cont.: Continuously trigger
<i>Trigger Level</i> [F3]	Sets the trigger level as a frequency. (The displayed level will only remain for a few moments)
<i>Trigger Delay</i> [F4]	Sets the trigger delay time: 0 to 1ks

9. Press *Return*[F7] to return to the AF Trigger menu and set the remaining triggering options:

<i>FreeRun</i> [F1]	Disables the trigger, this is the default setting.
<i>Start Time</i> [F3]	Sets the start time for the x-axis for the FM waveform in the top-half of the screen.
<i>Stop Time</i> [F4]	Sets the stop time for the x-axis for the FM waveform in the top-half of the screen.
<i>Action Now</i> [F5]	Turns FreeRun mode off and uses the user-defined trigger settings.



Note

The MAX and MIN measurements are held until higher or lower values are found. To reset the MAX and MIN measurements, press Measure > *Demod[F2]* > *FM Analysis[F1]* > *Min/Max Reset[F3]*.

FM Pass Fail Testing

Description	The Limit Edit function puts a pass limit on the FM deviation, carrier offset and carrier power.
-------------	--

Measurement Range	Frequency Deviation: 40Hz ~ 400kHz, 1Hz measurable
	<i>Carr. Offset</i> : 1Hz ~ 400kHz
	<i>Carrier Power</i> : -120dBm ~ 30dBm

- Operation: configuration
1. Press Measure > *Demod[F2]* > *FM Analysis[F2]* > *Limit Edit[F5]* and set the limits.

<i>FM Deviation[F1]</i>	If the measured deviation is above this limit, it will be judged as Fail.
<i>Carr. Offset[F2]</i>	If the measured carrier offset is above this limit, it will be judged as Fail.
<i>Carr. Power[F3]</i>	If the measured carrier power is above this limit, it will be judged as Fail.

 2. Press *Pass/Fail Test[F6]* and turn Pass/Fail on.

 3. The FM Measurement area in the bottom half of the screen will now include Pass/Fail indicators for the FM deviation, carrier offset and carrier power.

Pass: 

Fail: 

Example

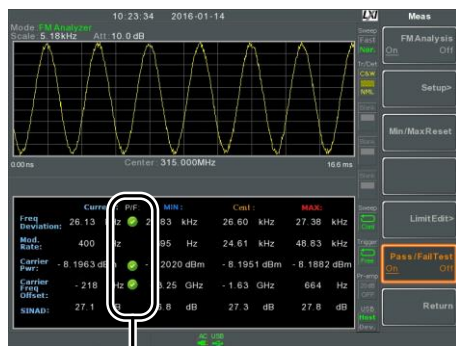

Pass/Fail judgments

AM/FM Demodulation

Description

The GSP-9330 has a convenient AM/FM demodulation function to tune into AM or FM broadcast signals and listen to the demodulated baseband signals using the ear phone out socket.

Operation: Setup

1. Set the center frequency to the desired FM/AM carrier frequency. See page 41 for details.
2. Set the span to zero. See page 46 for details.
3. Set the Preamp to Auto. See page 60.
4. Connect an antenna to the RF input.

Connection

Connect headphones or a speaker to the phone output port.



Operation

1. Press  > *Demod[F2]>Sound[F3]>Ear Phone*

Out[F1] and turn the ear phone out on.

2. Press *Volume*[F2] to set the volume output:
 Volume: 0~15, default 7

3. Press *Digital Gain Control*[F3] to change the gain:
 Gain: 0~18dB, 6dB step

4. Press *Demod Type*[F4] to choose AM or FM demodulation.

ASK Measurement

Description	The ASK function can be used to analyze ASK signals. It can either display the demodulated waveform or the symbols encoded in the signal. Manchester or Miller line codes can also be decoded.
-------------	--

Measurement items	AM Depth: Current, Min, Cent, Max
	Mod. Rate: Current, Min, Cent, Max
	Carrier Pwr: Current, Min, Cent, Max
	Carrier Freq Offset: Current, Min, Cent, Max
	SINAD: Current, Min, Cent, Max

- | | |
|--------------------------|--|
| Operation: configuration | <ol style="list-style-type: none"> 1. Set the center frequency to the carrier frequency (page 41). 2. Press  > <i>Demod</i>[F2] > <i>ASK</i>[F4] > <i>ASK Analysis</i>[F1] and turn ASK Analysis on. <ul style="list-style-type: none"> • Any other measurement mode will automatically be disabled. |
|--------------------------|--|

- The display splits into two screens. The top shows the ASK waveform in the wave view (time domain waveform) or the symbol view. The bottom screen shows the ASK measurements and Pass/Fail test results.

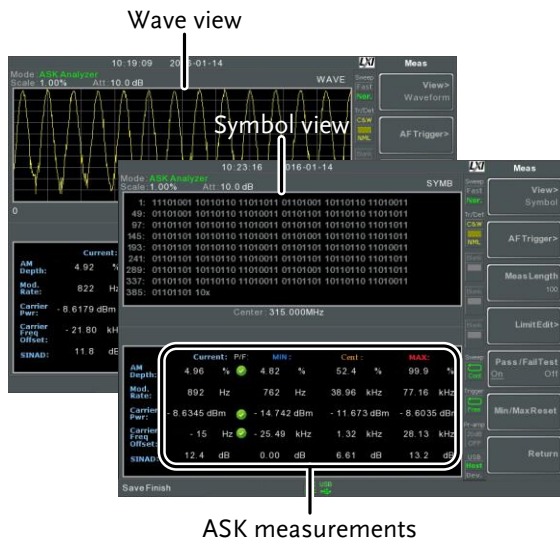

ASK measurements

- Press *Bit Rate*[F2] and set the Bit rate of the ASK signal.

Display View

- To toggle the top half of the screen between the Symbol view or Wave view, press *More*[F6]>*View*[1]>*Symbol*[F1] or *More*[F6]>*View*[1]>*Waveform*[F2].
- If the View is set to *Waveform*, press *Axis*[F4]>*Time Axis* [F1] to set the horizontal axis parameters:

Ref. Value[F1] Sets the starting time on the time axis.

<i>Ref. Pos[F2]</i>	Shifts the waveform X number of grid subdivisions.
<i>Scale/Div[F3]</i>	Sets the grid division scale when Auto Scale is Off.

7. Press *Depth Axis[F2]* to set depth (vertical) parameters:

<i>Ref. Value[F1]</i>	Offsets the reference position as a percentage of the vertical scale/div.
<i>Ref. Pos[F2]</i>	Sets the reference position of the waveform on a vertical grid subdivision (1:10).
<i>Scale/Div[F3]</i>	Sets the vertical grid division scale when Auto Scale is Off.
<i>Auto Scale[F4]</i>	Toggles auto-scaling execution.

Configuration:
Preamble/Sync

8. Press *Preamble/Sync[F5]* if any preamble or sync bits or words are configured:

<i>Preamble/Sync[F1]</i>	Toggle to On to activate the preamble/sync function.
<i>Preamble Bits[F2]</i>	Enter the number of preamble bits as integer: 0 to 16
<i>Sync Bits[F3]</i>	Enter the number of sync bits as integer: 0 to 16

	<i>Sync Words[F4]</i>	Enter the sync word in hexadecimal: 0000 to FFFF
Operation: AF trigger configuration	9. Press <i>More[F6]>Trigger[F2]></i> to set the AF(<u>A</u> SK/ <u>F</u> SK) triggering conditions:	
	<i>Free Run[F1]</i>	Disables the trigger, this is the default setting.
	<i>Trigger Condition[F2]> RF Trigger[F1]</i>	Sets the RF trigger level: -80 to +16dBm
	<i>Trigger Condition[F2]> Ext.Edge[F2]</i>	Sets the external trigger slope: Pos, Neg.
	<i>Trigger Condition[F2]> Video Edge[F3]</i>	Sets the video trigger slope: Off, Pos, Neg.
	<i>Trigger Mode[F3]</i>	Sets the triggering mode: Norm.: Normal trigger Sgl.: Single trigger Cont.: Continuously trigger
	<i>Trigger Delay[F4]></i>	Sets the trigger delay time: 0 to 1ks
	<i>Action Now[F5]</i>	Turns FreeRun mode off and uses the user-defined AF Trigger settings. Press <i>Action Now[F5]</i> to manually trigger.
	<i>Trigger Setup[F6]</i>	When the Single trigger mode succeeds, this menu will be available.

Trigger Setup[F6]>Start Bits Enter the position of the start bit as integer: 0 to 400.

Trigger Setup[F6]> Stop Bits Enter the position of the stop bit as integer: 0 to 400.



Note

The trigger icon will be replaced with the AF trigger when the AF trigger is used:



Symbol setup

10. Press *View[F1]>Symbol Setup[F3]>Decoding[F1]* to set the line decoding method. The decoded data can be seen when in the *Symbol* or *Waveform View*:

- None[F1]* No line decoding of data.
- Miller[F2]* Miller decoding (aka. Delayed Encoding).
- Manchester Encoding[F3]* Manchester encoding (aka. Phase Encoding).
- D_Manchester Encoding[F4]* Differencial Manchester encoding (aka. Phase Encoding).
- Bi-Phase[F5]* Bi-Phase Encoding (aka. Phase Encoding)



Note

Miller Encoding Definition:
Miller encoding will encode a “1” as a phase transition in the middle of a data period. A “0” is encoded the same as the previous bit. This means that only a “1” causes the data to transition from high or low.

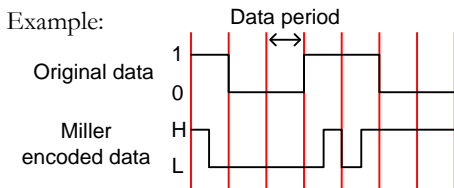

Manchester Encoding Definition:

Manchester encoding encodes a “1” or “0” on each transition in a data period. The Manchester definition used for the GSP-9330 uses a low to high transition to indicate “0”, and a high to low transition to indicate “1”.

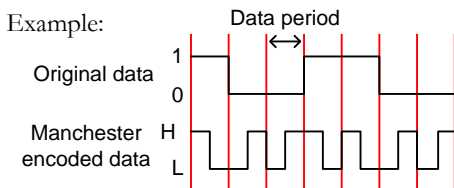

11. Press *View*[F1]>*Symbol Setup*[F3]>*Decode invert*[F2] to invert decode of decoding.

12. Press *View*[F1]>*Symbol Setup*[F3]>*Format*[F3] to set the format for the decoded data (Binary or Hexadecimal).

ASK Pass Fail Testing

Description	The Limit function puts a pass limit on the AM depth, carrier offset and carrier power.
-------------	---

Measurement Range	AM Depth:	5% ~ 95%
	<i>Carr. Offset:</i>	1Hz ~ 400kHz
	<i>Carrier Power:</i>	-120dBm ~ 30dBm

Operation:
configuration

- Press  > *Demod[F2]* > *ASK[F4]* > *More[F6]* > *Limit Edit[F4]* and set the limits.

<i>AM Depth[F1]</i>	If the measured depth is above this limit, it will be judged as Fail.
<i>Carr. Offset[F2]</i>	If the measured carrier offset is above this limit, it will be judged as Fail.
<i>Carr. Power[F3]</i>	If the measured carrier power is above this limit, it will be judged as Fail.
<i>Compare Values[F4]</i>	Compare the input value
<i>Compare Number[F5]</i>	Number of consecutive comparison
- Press *Return[F7]* to return to the previous menu.
- Press *Pass/Fail Test[F5]* to toggle the pass/fail testing on.
- The ASK Measurement area in the bottom half of the screen will now include Pass/Fail indicators for the AM depth, carrier offset and carrier power.

Pass: 

Fail: 

Example

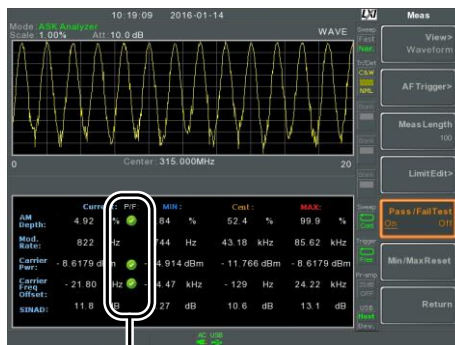

Pass/Fail judgments

FSK Measurement

Description

The FSK function can be used to analyze FSK signals. It can either display the demodulated waveform or the symbols encoded in the signal. Manchester or Miller line codes can also be decoded.

Measurement items

Freq Deviation:	Current, Min, Cent, Max
Mod. Rate:	Current, Min, Cent, Max
Carrier Pwr:	Current, Min, Cent, Max
Carrier Freq Offset:	Current, Min, Cent, Max
SINAD:	Current, Min, Cent, Max

Operation: configuration

1. Set the center frequency to the carrier frequency (page 41).
2. Press  > *Demod[F2]>FSK[F5]>FSK Analysis[F1]* and turn FSK analysis on.

- Any other measurement mode will automatically be disabled.
3. The display splits into two screens. The top shows the demodulated FSK waveform in the wave view (time domain waveform) or the symbol view. The bottom screen shows the FSK-specific measurements and pass/fail results.

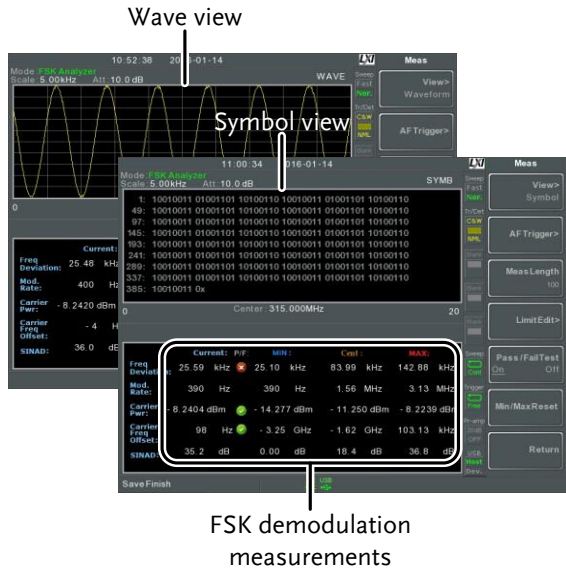

FSK demodulation measurements

4. Press *Bit Rate*[F2] and set the Bit rate of the FSK signal.

IF Bandwidth

5. Press *IF Bandwidth*[F3] to set the frequency deviation band for the FSK signal:

IF Bandwidth[F1] 10kHz, 30kHz, 100kHz, 300kHz, 1MHz.

Display View

6. To toggle the top half of the screen between the Symbol view or Wave view, press

*More[F6]>View[F1]>Symbol[F1] or
More[F6]>View[F1]>Waveform[F2].*

7. If the View is set to *Waveform*, press *Axis[F4]>Time Axis[F1]* to set the horizontal axis parameters:

<i>Ref. Value[F1]</i>	Sets the starting time on the time axis.
<i>Ref. Pos[F2]</i>	Shifts the waveform X number of grid subdivisions.
<i>Scale/Div[F3]</i>	Sets the grid division scale when Auto Scale is Off.

8. Press *Deviation Axis[F2]* to set deviation (vertical) parameters:

<i>Ref. Value[F1]</i>	Offsets the reference position (in frequency).
<i>Ref. Pos[F2]</i>	Sets the reference position of the waveform on a vertical grid subdivision (1:10).
<i>Scale/Div[F3]</i>	Sets the vertical grid division scale when Auto Scale is Off.
<i>Auto Scale[F4]</i>	Toggles auto-scaling execution.

Configuration:
Preamble/Sync

9. Press *Preamble/Sync[F5]* if any preamble or sync bits or words are configured:

<i>Preamble/Sync[F1]</i>	Toggle to On to activate the preamble/sync function.
--------------------------	--

<i>Preamble Bits[F2]</i>	Enter the number of preamble bits as integer: 0 to 16
<i>Sync Bits[F3]</i>	Enter the number of sync bits as integer: 0 to 16
<i>Sync Words[F4]</i>	Enter the sync word in hexadecimal: 0000 to FFFF

Operation:
AF trigger
configuration

10. Press *More[F6]>Trigger[F2]* to set the AF (ASK/FSK) triggering conditions:

<i>Free Run[F1]</i>	Disables the trigger, this is the default setting.
<i>Trigger Condition[F2]>RF Trigger[F1]</i>	Sets the RF trigger level: -80 to +16dBm
<i>Trigger Condition[F2]>Ext.Edge[F2]</i>	Sets the external trigger slope: Pos, Neg.
<i>Trigger Condition[F2]>Video Edge[F3]</i>	Sets the video trigger slope: Off, Pos, Neg.
<i>Trigger Mode[F3]</i>	Sets the triggering mode: Norm.: Normal trigger Sgl.: Single trigger Cont.: Continuously trigger
<i>Trigger Delay[F4]</i>	Sets the trigger delay time: 0 to 1ks

Action Now[F5] Turns FreeRun mode off and uses the user-defined AF trigger settings.

Press *Action Now[F5]* to manually trigger.

Trigger Setup[F6] When the Single trigger mode succeeds, this menu will be available.

Trigger Setup[F6]>Start Bits Enter the position of the start bit as integer: 0 to 400.

Trigger Setup[F6]> Stop Bits Enter the position of the stop bit as integer: 0 to 400.



Note

The trigger icon will be replaced with the AF trigger when the AF trigger is used:



Symbol setup

11. Press *View[F1]>Symbol Setup[F3]>Decoding[F1]* to set the line decoding method. The decoded data can be seen when in the *Symbol* or *Waveform View*:

None[F1] No line decoding of data.

Miller[F2] Miller decoding (aka. Delayed Encoding).

Manchester Encoding[F3] Manchester encoding (aka. Phase Encoding).

D_Manchester Encoding[F4] Differential Manchester encoding (aka. Phase Encoding).

Bi-Phase[F5]

Bi-Phase Encoding (aka. Phase Encoding)



Note

Miller Encoding Definition:

Miller encoding will encode a “1” as a phase transition in the middle of a data period. A “0” is encoded the same as the previous bit. This means that only a “1” causes the data to transition from high or low.

Example:

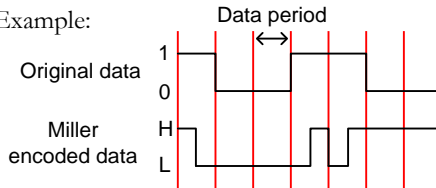

Manchester Encoding Definition:

Manchester encoding encodes a “1” or “0” on each transition in a data period. The Manchester definition used for the GSP-9330 uses a low to high transition to indicate “0”, and a high to low transition to indicate “1”.

Example:

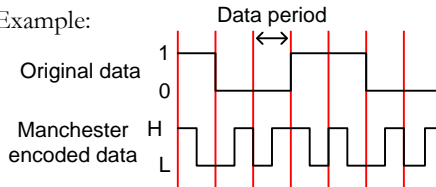

12. Press *View[F1]>Symbol Setup[F3]>Decode invert[F2]* to invert decode of decoding.

13. Press *View[F1]>Symbol Setup[F3]>Format[F3]* to set the format for the decoded data (Binary or Hexadecimal).

FSK Pass Fail Testing

Description	The Limit Edit function puts a pass limit on the FSK frequency deviation, carrier offset and carrier power.	
Measurement Range	Freq. Deviation:	40Hz ~ 400kHz, 1Hz measurable
	<i>Carr. Offset:</i>	1Hz ~ 400kHz
	<i>Carrier Power:</i>	-120dBm ~ 30dBm
Operation: configuration	1. Press  > <i>Demod</i> [F2] > <i>FSK</i> [F5] > <i>More</i> [F6] > <i>Limit Edit</i> [F4] and set the limits.	
	<i>Freq. Deviation</i> [F1]	If the measured deviation is above this limit, it will be judged as Fail.
	<i>Carr. Offset</i> [F2]	If the measured carrier offset is above this limit, it will be judged as Fail.
	<i>Carr. Power</i> [F3]	If the measured carrier power is above this limit, it will be judged as Fail.
	<i>Compare Values</i> [F4]	Compare the input value
	<i>Compare Number</i> [F5]	Number of consecutive comparison
	2. Press <i>Return</i> [F7] to return to the previous menu.	
3. Press <i>Pass/Fail Test</i> [F5] to toggle the pass/fail testing on.		

- The FSK Measurement area in the bottom half of the screen will now include Pass/Fail indicators for the frequency deviation, carrier offset and carrier power.

Pass: 

Fail: 

Example

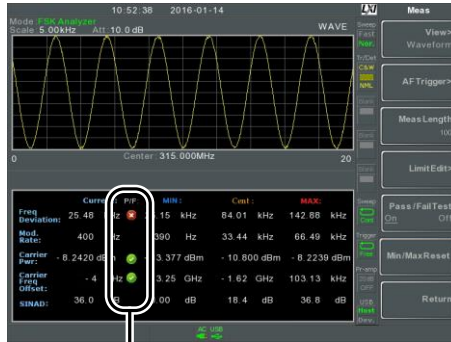

Pass/Fail indicators

2FSK Measurement

Description

2FSK is a binary FSK (frequency shift keying) form of modulation. 2FSK is commonly used to transmit data where an FSK modulated signal is composed of two different frequencies, one frequency represents the “1” data and the other frequency represents the “0” data.

For 2FSK measurement 2 traces will be created, one trace will show the 2FSK spectrum (trace 1, yellow) and the other trace (trace 2, purple) will show a MAX HOLD trace type with peak markers at the FSK carrier and hop frequencies.

Measurement items

Peak 1, Peak 2: frequency, amplitude
 Frequency Deviation: hertz

Carrier Offset:	frequency
Carrier Freq Offset:	frequency
Peak Threshold:	dBm
Max Hold:	dBm

Example

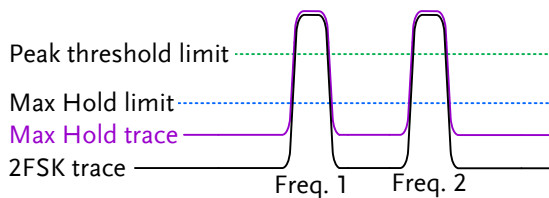

Operation

1. Set the frequency span to cover the 2FSK carrier and hop frequency. See page 41 for details.
2. Press  > 2FSK Meas[F3]>2FSK[F1] and turn 2FSK on.
 - Any other measurement mode will automatically be disabled.
3. The display splits into two screens. The top shows the trace with peak markers for the first and second FSK frequencies (carrier and hop frequency). The bottom screen shows the 2FSK measurement results in real time.

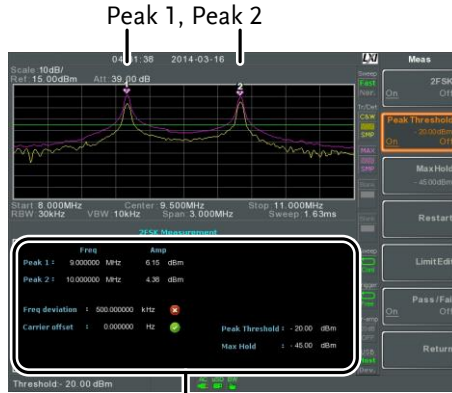

2FSK measurement

- To set the peak threshold line, press *Peak Threshold*:

Threshold range: -120dBm ~ 30.0 dBm

- To set max hold limit, press *Max Hold*:

Max Hold range: -130dBm ~ 30.0 dBm



Note

For more information about Peak Threshold and Max Hold parameters, please see the Trace chapter on page 77.

2FSK Pass Fail Testing

Description The Limit Edit function puts a pass limit on the frequency deviation and carrier power and a high/low limit on the amplitude of each peak.

Measurement Range	Freq. Deviation:	1Hz ~ 400kHz
	Carr. Offset:	1Hz ~ 400kHz
	High Limit:	-120dBm ~ 30dBm
	Low Limit:	-120dBm ~ 30dBm

Operation:
configuration

1. Press  > *2FSK Meas[F3]* > *Limit Edit[F5]* and set the limits.

<i>Freq. Deviation[F1]</i>	If the measured deviation is above this limit, it will be judged as Fail.
<i>Carr. Offset[F2]</i>	If the measured carrier offset is above this limit, it will be judged as Fail.
<i>High Limit[F4]</i>	If the amplitude of one of the peaks is above the high limit, it will be judged as Fail.
<i>Low Limit[F5]</i>	If the amplitude of one of the peaks is below the low limit, it will be judged as Fail.

2. Press *Pass/Fail Test[F6]* and turn Pass/Fail on.

3. The 2FSK area in the bottom half of the screen will now include Pass/Fail indicators for the frequency depth, carrier offset, high limit and low limit.

Pass: 

Fail: 

Example

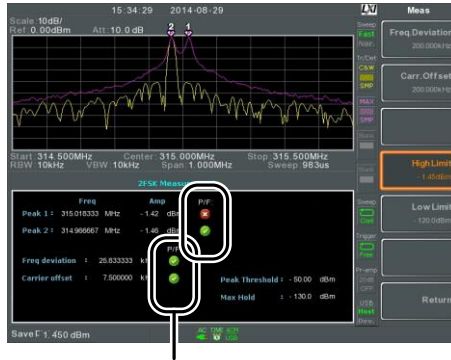

Pass/Fail judgments

Phase Jitter Measurement

Description	Phase Jitter refers to the amount of phase fluctuation and can be used to evaluate stability of a signal in the time domain.	
Parameters	Start Offset:	The start frequency with respect to the center frequency.
	Stop Offset:	The stop frequency with respect to the center frequency.
Measurement items	Carrier Power:	dBm
	Jitter in phase:	rad
	Jitter in time:	ns

Example

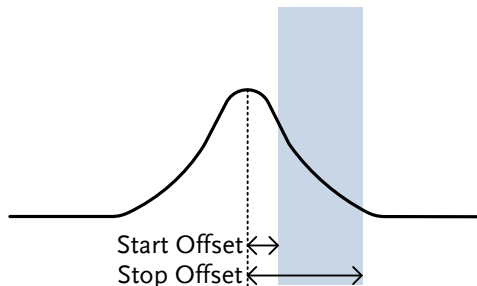

Operation:
Setting up the
main channel

1. Press **Measure** > *Phase Jitter*[F4]>*Phase Jitter*[F1] and turn Phase Jitter on.
 - Any other measurement mode will automatically be disabled.
2. The display splits into two screens. The top shows the trace with the start and stop offsets. The bottom screen shows the phase jitter measurements.



Phase jitter measurements

3. Press *Start Offset*[F2] to set the start offset:
Offset: (0Hz ~ 1/2 span freq)

4. Press *Stop Offset*[F3] to set the stop offset:

Offset: (0Hz ~ ½ span freq)



The phase jitter measurements are strongly tied to the RBW and VBW.

Spectrum Emission Mask Overview

Description

SEM measurements are used to measure the out-of-channel emissions relative to the in-channel power. SEM measurements are usually calculated for specified power bands at a number of different offsets to the carrier frequency. SEM measurements are often carried out for a number of different wireless standards.

For 3GPP, the GSP-9330 supports BS (base station) and UE (user equipment) testing standards for both FDD (frequency-division duplexing) and TDD (time-division duplexing) modes.

The GSP-9330 also supports SEM testing for 802.11b, 802.11g, 802.11n and 802.16 as well as user defined emission mask testing

Example

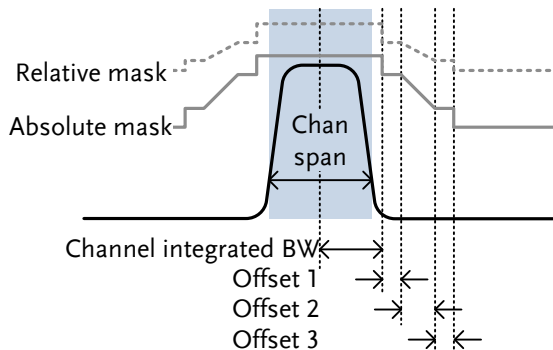

Parameters

ChanIntegBW:	Channel Integration Bandwidth. The ChanIntegBW is used to measure the in-channel power.
Chan Span:	Used to define the span of the main channel when measuring the channel power.
RBW:	Sets the resolution bandwidth for the main channel when measuring the in-channel power.
Total Pwr Ref:	The total power of the carrier that is used as the reference for calculating the offset power.
PSD Ref:	The mean power spectral density of the carrier that is used as the reference for calculating the offset power.
Select Offset:	Selects the offset pairs (1 ~ 5) used for configuration.
Start Freq:	Sets the start frequency offset

	for the selected offset number.
Stop Freq:	Sets the stop frequency offset for the selected offset number.
RBW:	Sets the resolution bandwidth of the selected offset number.
Abs Start:	Sets the absolute level limit at the Start Freq for selected offset number.
Abs Stop:	Sets the absolute level limit at the Stop Freq for the selected offset number. The Abs Stop level limit can be set to Couple or Man. Man allows Abs Stop to be user-defined, while Couple will lock Abs Stop to the Abs Start level limit.
Rel Start:	Sets the relative level limit at the Start Freq for the selected offset number.
Rel Stop:	Sets the relative level limit at the Stop Freq for the selected offset number. Rel Stop can be set to Couple or Man. Man allows Rel Stop to be user-defined, while Couple will lock Rel Stop to the Rel Start level limit.
Fail Mask:	Sets the fail conditions for measurement with regards to the level limits: Absolute, Relative, Absolute &

		Relative, Absolute or Relative.
Measurement items	Main Channel Bandwidth:	Unit: Hz
	Total Power:	Unit: dBm
	PSD (Power Spectral Density):	Unit: dBm/Hz
	Offset 1~5:	Lower dBm, Upper dBm

3GPP Operating Bands*

Operating Band	UL Frequencies UE transmit, Node B receive	DL Frequencies UE receive, Node B transmit
I	1920~1980MHz	2110~2170MHz
II	1850~1910MHz	1930~1990 MHz
II	1710~1785MHz	1805~1880MHz
IV	1710~1755MHz	2110~2155MHz
V	824~849MHz	869~894MHz
VI	830~840MHz	875~885MHz
VII	2500~2570MHz	2620~2690MHz
VIII	880~915MHz	925~960MHz
IX	1749.9~1784.9MHz	1844.9~1879.9MHz
X	1710~1770MHz	2110~2170MHz
XI	1427.9~1452.9MHz	1475.9~1500.9MHz
XII	698~716MHz	728~746MHz
XIII	777~787MHz	746~756MHz
XIV	788~796MHz	758~768MHz
XV	Reserved	Reserved
XVI	Reserved	Reserved
XVII	Reserved	Reserved
XVIII	Reserved	Reserved

XIX	830~845MHz	875~890MHz
XX	832~862MHz	791~821MHz
XXI	1447.9~1462.9MHz	1495.9~1510.9MHz
XXV	1850~1915MHz	1930~1995MHz

*for FDD, referenced from ETSI:

3GPP TS 25.101 version 10.2.0 Release 10

3GPP TS 25.104 version 10.2.0 Release 10

3GPP-FDD BS For the FDD configuration, different limits can be chosen based on the total channel power, P.

The default value for Δf_{max} is 12.5MHz. Δf_{max} can be user-defined.

The channel span is set to 5MHz.

Note: A, B, C, D, E denote offsets 1 to 5, respectively.

	Unit: MHz	Abs ^[1]	RBW
$P \geq 43$	$2.5 \leq A < 2.7$	-14dBm	30kHz
	$2.7 \leq B < 3.5$	-14 ~ -26dBm	30kHz
	$3.5 \leq C < \Delta f_{max}$	-13dBm	1MHz
$39 \leq P < 43$	Unit: MHz	Abs ^[1]	RBW
	$2.5 \leq A < 2.7$	-15dBm	30kHz
	$2.7 \leq B < 3.5$	-14 ~ -26dBm	30kHz
	$3.5 \leq C < 7.5$	-13dBm	1MHz
	$7.5 \leq D < \Delta f_{max}$	P-56dB	1MHz
$31 \leq P < 39$	Unit: MHz	Abs ^[1]	RBW
	$2.5 \leq A < 2.7$	P-53dB	30kHz
	$2.7 \leq B < 3.5$	P-53dB~ P-56dB	30kHz
	$3.5 \leq C < 7.5$	P-52dB	1MHz

	$7.5 \leq D < \Delta f_{max}$	P-56dB	1MHz
P<31	Unit: MHz	Abs ^[1]	RBW
	$2.5 \leq A < 2.7$	-22dBm	30kHz
	$2.7 \leq B < 3.5$	-22 ~ -34dBm	30kHz
	$3.5 \leq C < 7.5$	-21dBm	1MHz
	$7.5 \leq D < \Delta f_{max}$	-25dBm	1MHz

For P<31, two additional power limits (shown below) can be selected via the *Additional Max Out. Pwr* option for Home BS applications:

(The default value for Δf_{max} is 14.5 MHz. Δf_{max} can be user-defined)

$6 \leq P \leq 20$	Unit: MHz	Abs ^[1]	RBW
	$12.5 \leq E < \Delta f_{max}$	P- 56dB	1MHz
P<6	Unit: MHz	Abs ^[1]	RBW
	$12.5 \leq E < \Delta f_{max}$	-50dBm	1MHz

3GPP-FDD BS Additional Requirements

For operation in bands II, IV, V, X, XII, XIII, XIV and XXV, additional requirements (listed below) apply in addition to the minimum requirements listed above.

Bands: II, IV, X	Unit: MHz	Additional ^[3]	RBW
	$2.5 \leq A < 3.5$	-15dBm	30kHz
	$3.5 \leq B < \Delta f_{max}$	-13dBm	1MHz
Bands: V	Unit: MHz	Additional ^[3]	RBW
	$2.5 \leq A < 3.5$	-15dBm	30kHz
	$3.5 \leq B < \Delta f_{max}$	-13dBm	100kHz
Bands:	Unit: MHz	Additional ^[3]	RBW
	$2.5 \leq A < 3.5$	-13dBm	30kHz

XII, XIII, XIV	$3.5 \leq B < \Delta f_{max}$	-13dBm	100kHz
----------------	-------------------------------	--------	--------

3GPP-FDD UE The channel span is set to 5MHz.

Note: A, B, C, D, E denote offsets 1 to 5, respectively.

Unit: MHz	Rel	Abs ^[1]	RBW
$2.5 \leq A < 3.5$	-35~-50dBc	-71.1dBm	30kHz
$3.5 \leq B < 7.5$	-35~-39dBc	-55.8dBm	1MHz
$7.5 \leq C < 8.5$	-39~-49dBc	-55.8dBm	1MHz
$8.5 \leq D < 12.5$	-49~-49dBc	-55.8dBm	1MHz

3GPP-FDD UE Additional requirements for 3GPP-FDD UE.

Bands II, IV, X	Unit: MHz	Additional ^[3]	RBW
	$2.5 \leq A < 3.5$	-15dBm	30kHz
$3.5 \leq B < 12.5$	-15dBm	1MHz	
Band V	Unit: MHz	Additional ^[3]	RBW
	$2.5 \leq A < 3.5$	-15dBm	30kHz
$3.5 \leq B < 12.5$	-13dBm	100kHz	
Bands XII, XIII, XIV	Unit: MHz	Additional ^[3]	RBW
	$2.5 \leq A < 3.5$	-13dBm	30kHz
$3.5 \leq B < 12.5$	-13dBm	100kHz	

3GPP-TDD BS 3.84Mcps* For the TDD configuration, different limits can be chosen based on the total channel power,

The channel span:
3.84Mcps: 5MHz.

Note: A, B, C, D, E denote offsets 1 to 5, respectively.

P _{≥43}	Unit: MHz	Abs ^[1]	RBW
$2.5 \leq A < 2.7$	-14dBm	30kHz	
$2.7 \leq B < 3.5$	-14 ~ -26dBm	30kHz	

	$3.5 \leq C < 12$	-13dBm	1MHz
$39 \leq P < 43$	Unit: MHz	Abs ^[1]	RBW
	$2.5 \leq A < 2.7$	-14dBm	30kHz
	$2.7 \leq B < 3.5$	-14 ~ -26dBm	30kHz
	$3.5 \leq C < 7.5$	-13dBm	1MHz
$31 \leq P < 39$	$7.5 \leq D < 12$	P-56dB	1MHz
	Unit: MHz	Abs ^[1]	RBW
	$2.5 \leq A < 2.7$	P-53dBm	30kHz
	$2.7 \leq B < 3.5$	P-53~P-65dBm	30kHz
	$3.5 \leq C < 7.5$	P-52dBm	1MHz
$P \leq 31$	$7.5 \leq C < 12$	P-56dBm	1MHz
	Unit: MHz	Abs ^[1]	RBW
	$2.5 \leq A < 2.7$	-22dBm	30kHz
	$2.7 \leq B < 3.5$	-22 ~ -34dBm	30kHz
	$3.5 \leq C < 7.5$	-21dBm	1MHz
	$7.5 \leq D < 12$	-25dBm	1MHz

*referenced from ETSI:

3GPP TS 25.102 version 10.2.0 Release 10

3GPP TS 25.105 version 10.3.0 Release 10

3GPP-TDD BS
1.28Mcps

The channel span:
1.28Mcps: 1.6MHz.

$P \geq 34$	Unit: MHz	Abs ^[1]	RBW
	$0.8 \leq A < 1$	-20dBm	30kHz
	$1 \leq B < 1.8$	-20 ~ -28dBm	30kHz
	$1.8 \leq C < 3.5$	-13dBm	1MHz
$26 \leq P < 34$	Unit: MHz	Abs ^[1]	RBW
	$0.8 \leq A < 1$	P-54dB	30kHz
	$1 \leq B < 1.8$	P-54~P-62dB	30kHz
	$1.8 \leq C < 3.5$	P-47dB	1MHz

P<26	Unit: MHz	Abs ^[1]	RBW
	0.8 ≤A<1	-28dBm	30kHz
	1≤B<1.8	-28~-36dBm	30kHz
	1.8≤C<3.5	-21dBm	1MHz

3GPP-TDD BS
7.68 Mcps

The channel span:
7.68Mcps: 10MHz.

P≥43	Unit: MHz	Abs ^[1]	RBW
	5 ≤A<5.2	-17dBm	30kHz
	5.2≤B<6	-17 ~ -29dBm	30kHz
39≤P<43	6≤C<24.5	-16dBm	1MHz
	Unit: MHz	Abs ^[1]	RBW
	5≤A<5.2	-17dBm	30kHz
	5.2≤B<6	-17 ~ -29dBm	30kHz
31≤P<39	6≤C<15	-16dBm	1MHz
	15≤D≤24.5	P-59dB	1MHz
	Unit: MHz	Abs ^[1]	RBW
	5≤A<5.2	P-56dB	30kHz
P<31	5.2≤B<6	P-56~P-68dB	30kHz
	6≤C<15	P-55dB	1MHz
	15≤D≤24.5	P-59dB	1MHz
	Unit: MHz	Abs ^[1]	RBW
	5≤A<5.2	-25dBm	30kHz
5.2≤B<6	-25~-37dBm	30kHz	
6≤C<15	-24dBm	1MHz	
15≤D≤24.5	-28dBm	1MHz	

3GPP-TDD UE The channel span:
 3.84Mcps: 5MHz.
 1.28Mcps: 1.6MHz.
 7.68Mcps: 10MHz.

Note: A, B, C, D, E denote offsets 1 to 5, respectively.

3.84Mcps	Unit: MHz	Rel ^[2]	RBW
	$2.5 \leq A < 3.5$	-35~-50dBc	30kHz
	$3.5 \leq B < 7.5$	-35 ~ -39dBc	1MHz
	$7.5 \leq C < 8.5$	-39~-49dBc	1MHz
1.28Mcps	Unit: MHz	Rel ^[2]	RBW
	$0.8 \leq A < 1.8$	-35~-49dBc	30kHz
	$1.8 \leq B < 2.4$	-49~-59.2dBc	30kHz
	$2.4 \leq C < 4$	-44dBc	1MHz
7.68Mcps	Unit: MHz	Rel ^[2]	RBW
	$5 \leq A < 5.75$	-38~-46dBc	30kHz
	$5.75 \leq B < 7$	-46 ~ -53dBc	30kHz
	$7 \leq C < 15$	-38~-42dBc	1MHz
	$15 \leq D < 17$	-42~-52dBc	1MHz
	$17 \leq E < 25$	-53dBc	1MHz

802.11b* The channel span: 22MHz

Note: A, B denotes offsets 1 and offset 2.
 Here the default value of “f” is 24MHz. This can be user-defined.

Unit: MHz	Rel ^[2]	RBW
$11 \leq A < 22$	-30dBc	100kHz
$22 \leq B < f$	-50dBc	100kHz

*reference: IEEE Std 802.11b-1999

802.11g

The channel span:
 ERP-OFDM/DSSS-OFDM : 18MHz
 ERP-DSSS/ERP-PBCC/ERP-CCK: 22MHz

Note: A, B, C, D denote offsets 1 to 4, respectively.
 Here the default value of “f” is 40MHz (ERP-OFDM/
 DSSS-OFDM) or 25MHz (ERP-DSSS/ ERP-PBCC/
 ERP-CCK). This can be user-defined.

	Unit: MHz	Rel ^[2]	RBW
ERP-OFDM/ DSSS- OFDM	$9 \leq A < 11$	-0~-20dBc	100kHz
	$11 \leq B < 20$	-20~-28dBc	100kHz
	$20 \leq C < 30$	-28~-40dBc	100kHz
	$30 \leq D < f$	-40dBc	100kHz
	Unit: MHz	Rel ^[2]	RBW
ERP-DSSS/ ERP-PBCC/ ERP-CCK	$11 \leq A < 22$	-30dBc	100kHz
	$22 \leq B < f$	-50dBc	100kHz

*reference: IEEE Std 802.11a-1999

802.11n

The channel span:
 CH BW 20MHz: 18MHz
 CH BW 40MHz: 38MHz

Note: A, B, C, D denote offsets 1 to 4, respectively.
 Here the default value of “f” is 40MHz(CHBW
 20MHz) or 70MHz(CHBW 40MHz). This can be user-
 defined.

	Unit: MHz	Rel ^[2]	RBW
CH BW 20MHz	$9 \leq A < 11$	-0~-20dBc	100kHz
	$11 \leq B < 20$	-20~-28dBc	100kHz
	$20 \leq C < 30$	-28~-45dBc	100kHz
	$30 \leq D < f$	-45dBc	100kHz

	Unit: MHz	Rel ^[2]	RBW
CH BW 40MHz	$19 \leq A < 21$	0~-20dBc	100kHz
	$21 \leq B < 40$	-20~-28dBc	100kHz
	$40 \leq C < 60$	-28~-45dBc	100kHz
	$60 \leq D < f$	-45dBc	100kHz

*reference: IEEE Std 802.1n-2009

802.16* The channel span:
 CH BW 20MHz: 19MHz
 CH BW 10MHz: 9.5MHz

Note: A, B, C, D denote offsets 1 to 4, respectively.
 Here the default value of “f” is 16.75MHz(CHBW 20MHz) or 31.5MHz(CHBW 10MHz). This can be user-defined.

	Unit: MHz	Rel ^[2]	RBW
CH BW 20MHz	$9.5 \leq A < 10.9$	0~-25dBc	100kHz
	$10.9 \leq B < 19.5$	-25~-32dBc	100kHz
	$19.5 \leq C < 29.5$	-32~-50dBc	100kHz
	$29.5 \leq D < f$	-50dBc	100kHz
	Unit: MHz	Rel ^[2]	RBW
CH BW 10MHz	$4.75 \leq A < 5.45$	0~-25dBc	100kHz
	$5.45 \leq B < 9.75$	-25~-32dBc	100kHz
	$9.75 \leq C < 14.75$	-32~-50dBc	100kHz
	$14.75 \leq D < f$	-50dBc	100kHz

*reference: IEEE Std 802.16-2009



Note

[1] Abs: Absolute limit

[2] Rel: Relative limit(to the total power or the power spectral density, depending on the compliance of the main channel)

[3] Additional: Additional absolute limit

Pass Fail Criteria:

Case 1: When both Abs and Rel are used, the

highest value (Abs or Rel) is used as the Pass/Fail judgment. The trace points under the limit indicate a pass.

Case2: If the additional limit is used, the higher value from case1 is compared to the additional limit. The lowest one is used as the pass/fail judgment.

Spectrum Emission Mask Testing

Description	For spectrum emission mask testing, the GSP-9330 has pre-defined testing parameters for 3GPP, 802.11x and 802.16. The GSP-9330 also allows you to perform user-defined SEM testing.
-------------	---

- | | |
|------------|--|
| Operation: | <ol style="list-style-type: none">1. Press  > SEM[F5]>SEM[F2] and turn SEM on.<ul style="list-style-type: none">• <i>Any other measurement mode will automatically be disabled.</i>2. The display splits into two screens. The top shows the trace with the absolute and or relative masks. The bottom screen shows the SEM measurement results. |
|------------|--|
-

Absolute
limit line

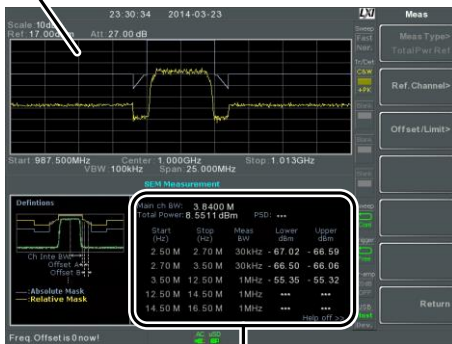

SEM measurements

User Defined Parameters

1. Press *Setup*[F1]>*User Define*[F6] to set SEM measurement to user defined parameters.
2. Press *Meas Type*[F1] choose between *TotalPwrRef*[F1] or *PSDRef*[F2].
3. Press *Ref. Channel*[F2] and set the following:

<i>ChanIntegBW</i> [F1]	Sets the channel integration bandwidth.
<i>Chan Span</i> [F2]	Sets the channel span
<i>RBW</i> [F3]	Sets the resolution bandwidth.
<i>TotalPwrRef</i> [F4]/ <i>PSDRef</i> [F4]	Sets the total power/PSD reference level.
4. Press *Return*[F7] to return to the previous menu.

5. Press *Offset/Limit*[F3] to set the offset parameters:

<i>SelectOffset</i> [F1]	Select which offset to edit.
[F2]	Toggles the selected offset on/off.
<i>StartFreq</i> [F3]	Sets the start frequency of the selected offset.
<i>StopFreq</i> [F4]	Sets the Stop Frequency of the selected offset.
<i>RBW</i> [F5]	Sets the RBW of the selected offset.

6. Press *More 1/2*[F6] to set absolute and relative level limits and conditions:

<i>Abs Start</i> [F2]	Sets the absolute start level limit for the selected offset.
<i>Abs Stop</i> [F3]	Sets the absolute stop level limit for the selected offset.
	Man: Allows a user-defined Abs Stop level
	Couple: Sets the Abs Stop level to the Abs Start level.
<i>Rel Start</i> [F4]	Sets the relative start level limit for the selected offset.

<i>Rel Stop[F5]</i>	Sets the relative stop level for the selected offset. Man: Allows a user-defined Abs Stop level. Couple: Sets the Rel Stop level to the Rel Start level.
---------------------	--

7. Press *Fail Mask[F6]* to set the Fail Mask conditions:

<i>Absolute[F1]</i>	Sets the fail condition to the Absolute level limit.
---------------------	--

<i>Relative[F2]</i>	Sets the fail condition to the relative level limit.
---------------------	--

<i>Abs AND Rel[F3]</i>	Sets the fail condition as both the absolute and relative level limits.
------------------------	---

<i>Abs OR Rel[F4]</i>	Sets the fail condition to either the absolute or relative level limits.
-----------------------	--

8. Press *Select Offset[F1]* and repeat the above steps for any other offsets.

Offset:	1~5
---------	-----

Pre-Set Test Parameters:
3GPP

For details on 3GPP SEM test parameters, please see the SEM overview on page 161.

1. Press *Setup[F1]>3GPP[F1]* to choose 3GPP measurement.
2. Press *Ref. Channel[F2]* and set the following:

RBW[F3] Sets the resolution bandwidth.

3. All other reference channel settings are pre-defined.
4. Press *Return[F7]* to return the previous menu.
5. Press *Offset/Limit[F3]>Duplexing Mode[F1]* and choose FDD or TDD duplexing:
6. For FDD, press *FDD Setup[F2]* set the FDD parameters, for TDD, press *TDD Setup[F3]*:

Transmission[F1] Toggles between BS and UE testing

Chip Rate[F2] Selects the bandwidth of the RRC filter that is used to measure the in-channel power for TDD duplexing:
3.84MHz, 1.28MHz,
7.68MHz

Max Out Pwr[F2/F3] Sets the maximum output power for BS tests:
P>=43
39<=P<=43
31<=P<=39
P<31

<i>Add.limits[F4]</i>	Selects the operating bands for FDD duplexing: None BandII BandIV BandV BandX BandX11 BandXIII BandXIV
<i>MinOffset/ Limit Value[F5]</i>	Allows you to view the parameters of each of the offsets, including start/stop frequency, RBW, Abs Start/Stop and Rel Start/Stop.

Pre-Set Test
Parameters:
802.XX

For details on 802.11x and 802.16 SEM test parameters, please see the SEM overview on page 161

1. Press *Setup[F1]>* and choose a 802.XX test:

802.11b[F2]

802.11g[F3]

802.11n[F4]

802.16[F5]

2. Press *Ref. Channel[F2]* to view the predefined settings for channel integrated bandwidth, channel span, RBW and PSD ref.

3. Press *Offset/Limit[F3]* to view the parameter values of each of the offsets, including Start and Stop Frequency, RBW, Rel Start and Stop

Third Order Intermodulation Distortion (TOI)

Description Third order intermodulation distortion measurement is used to calculate the TOI products caused by two signals that are close together in frequency in a non-linear system. Both the upper and lower third order intercept points (IP3) are calculated. Markers are placed at the frequencies of the TOI products and their respective base signals.

Limits can be placed on the upper and lower TOI products for limit testing.

Parameters	Reference Lower	Sets the reference level to lowest base signal
	Reference Upper	Set the reference level to the highest base signal
	Limit	Sets the limit in dBm for pass/fail testing
	Pass/Fail Test	Enables/disables pass/fail testing.

Measurement items	Base Upper	Frequency, dBm, dBc
	Base Lower	Frequency, dBm, dBc
	3rd Order Lower	Frequency, dBm, dBc, limit, Intercept point
	3rd Order Upper	Frequency, dBm, dBc, limit, Intercept point
	Δf	Frequency

Example

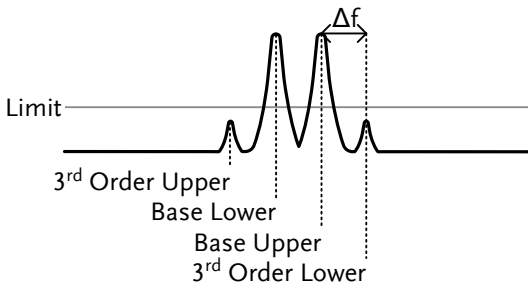

Operation:

1. Press **Measure** > **TOI[F6]** > **TOI[F1]** and turn TOI on.
 - Any other measurement mode will automatically be disabled.
2. The display splits into two screens. The top shows the trace with markers in the upper and lower base frequencies and the upper and lower 3rd order intermodulation products. The bottom screen shows the TOI measurements and pass/fail results.

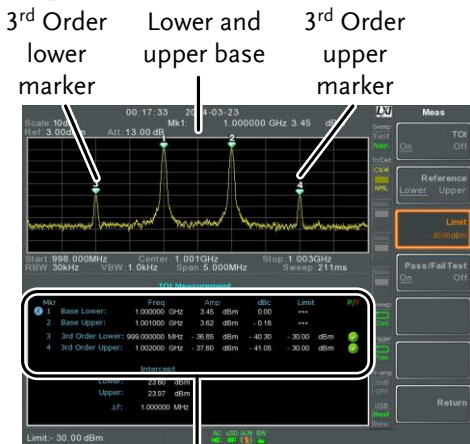



TOI measurement and results

3. Press *Reference*[F2] to set the reference to the upper or lower base frequencies.

The  icon will be displayed next to the selected upper or lower reference.

4. Press *Limit*[F3] and set the limit for the upper and lower 3rd order intermodulation product amplitude.
5. Press *Pass/Fail Test*[F4] to toggle pass/fail testing on/off.

The  pass or  fail icon will be displayed depending on the limit set above.

CNR/CSO/CTB Measurement

Carrier to Noise Ratio (CNR)

Description	Carrier to noise ratio calculates the difference in amplitude between the carrier signal and the noise level present in the transmission. CNR measurements are used for both analog and digital CATV.	
Parameters	Noise Marking	Sets the position of the delta marker ($\Delta 1$) using two options: MIN: The delta marker will search for the minimum between the carrier frequency and the carrier frequency + 4MHz.

		Δ Marker: User defined delta marker position.
Measurement items	Visual Carrier	frequency, amplitude
	CNR	amplitude difference
	Δf	frequency difference between visual carrier and noise marker.

Example

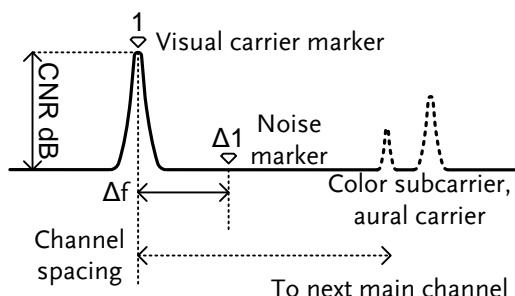

Operation:

1. Press **Measure** > More[F7] > CNR/CSO/CTB[F1] > Setup[F1] > CNR[F1] to choose CNR measurement.
2. Press *Noise Marking*[F1] and toggle the noise marker type between Min and Δ Marker.
3. If Min was selected, press *Return*[F7] to return to the previous menu.
4. If Δ Marker was selected, press **Marker** > *Delta*[F4] > *Delta*[F1] and set the delta marker position.
 - See page 92 for details on moving markers.

Press **Measure** > **CNR/CSO/CTB[F7]** to return to the previous menu.

5. Press **CNR[F2]** and turn CNR on.
 - Any other measurement mode will automatically be disabled.
 - Ensure the aural and color subcarriers are disabled before CNR is turned on.
6. The display splits into two screens. The top shows the trace with the visual carrier marker and the noise marker. The bottom screen shows the CNR measurements.

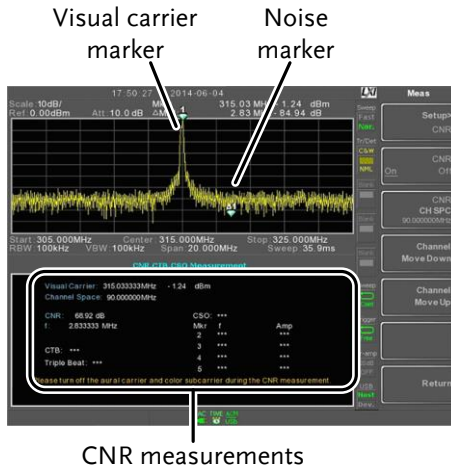

CNR measurements

7. Press **CNR CH SP[F2]** to set the channel space.

Range: 0~3.25GHz

8. Press **Channel Move Down[F4]** or **Channel Move Up [F5]** to move to the next or previous channel.



Note

Ensure the aural and color subcarriers are turned off when making CNR measurements.

Composite Second Order (CSO)

Description Composite Second Order measurement calculates the difference in amplitude between the carrier signal and the composite second order beat.

Parameters CSO CH SP: The channel space.

Measurement items Visual Carrier: frequency, amplitude
 Channel Space: frequency
 CSO: amplitude difference

Example

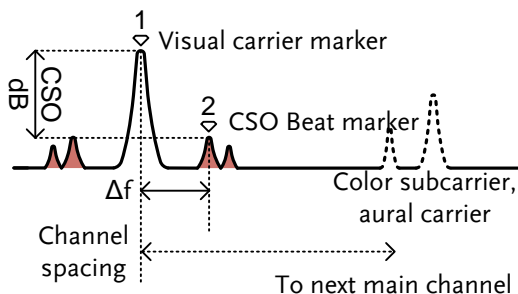

Operation:

1. Press **Measure** > **More**[F7]>**CNR/CSO/CTB**[F1]>**Setup**[F1]> **CSO**[F2] and choose CSO.
2. Press **CSO**[F2] and toggle CSO on.
 - Any other measurement mode will automatically be disabled.

- The display splits into two screens. The top shows the trace with the visual carrier marker and the CSO beat marker. The bottom screen shows the CSO measurements.

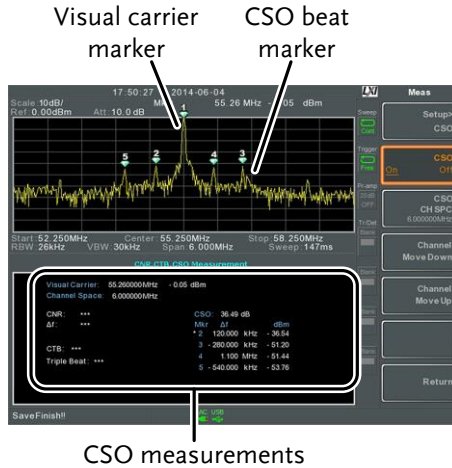

- Press *CSO CH SPC*[F3] to set the channel space.
Range: 0~3.25GHz
- Press *Channel Move Down*[F4] or *Channel Move Up* [F5] to move to next or previous channel.

Composite Triple Beat (CTB)

Description	Composite triple beat measurement calculates the difference in amplitude between the visual carrier and the composite triple beat amplitude.
Measurement items	Visual Carrier: frequency, amplitude CTB: amplitude difference from the visual carrier and the triple beat Triple Beat: amplitude

Example

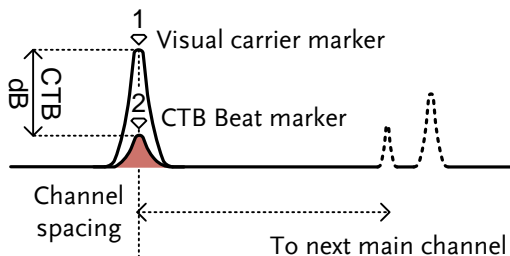

Operation:

1. Press **Measure** > **More[F7]>CNR/CSO/CTB[F1]>Setup[F1]>CTB[F3]>Return[F7]** to choose CTB measurement and return to the previous menu.
2. Press **CTB[F2]** and turn CTB on.
 - *Any other measurement mode will automatically be disabled.*
3. The display splits into two screens. The top shows the trace with the visual carrier marker. The bottom screen shows the CTB measurements.
 - *This will place a marker (1) on the visual carrier and record the amplitude.*

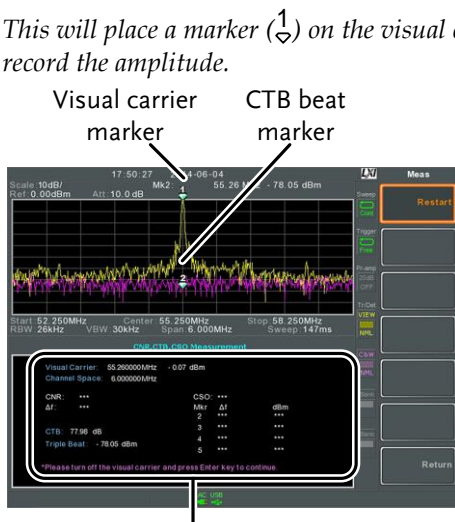

CTB measurements

4. Turn off the visual carrier signal from the input and press the  key on the front panel.
5. A second trace will appear to mark the CTB amplitude.
 - *This will place a marker ($\frac{2}{\diamond}$) on the second trace and calculate the difference ($\frac{1}{\diamond}-\frac{2}{\diamond}$).*
6. Press CTB CH SP[F2] to set the channel space.
 Range: 0~3.25GHz
7. Press *Channel Move Down*[F4] or *Channel Move Up* [F5] to move to next or previous channel.



Note

To perform the CTB measurement again, press *Setup*[F1]>*CTB*[F3]> *Restart*[F1].

Harmonic Measurements

Description	The Harmonic function can be used to easily measure the amplitude of the fundamental frequency and its harmonic frequencies up to the 10 th harmonic. The function can also measure the amplitude relative to the fundamental (dBc) and the total harmonic distortion (THD).	
Measurement items	Amplitude	Amplitude of each harmonic (dBm).
	dBc	Amplitude of each harmonic relative to the fundamental.

THD The square root of the sum of the amplitude of each harmonic frequency squared, divided by the amplitude of the fundamental frequency.

$$\text{THD} = \frac{\sqrt{V_2^2 + V_3^2 + \dots + V_n^2}}{V_1}$$

Example

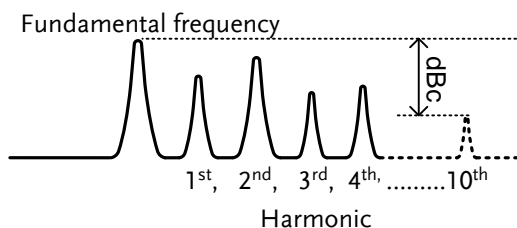

Operation

1. Press Measure > *More*[F7]>*Harmonic*[F2]>*Harmonic*[F1] and turn Harmonic on.
 - *Any other measurement mode will automatically be disabled.*
2. The display splits into two screens. The top shows a bar graph with fundamental measurement (1) and the each of the harmonic frequencies (2~ 10). The bottom screen shows the amplitude, dBc and THD results.

Fundamental frequency

Nth order harmonics



Harmonic measurement

3. Press *Fundamental Freq.*[F2] to set the fundamental frequency.
4. Press *Number of Order*[F3] to set the number of harmonic frequencies to measure.
 - *The number of harmonic frequencies set will affect the THD measurement.*
5. Press *RBW*[F4] and set the RBW to Auto or Man.
 - Set the resolution bandwidth and unit for RBW Man mode.
 - *The RBW setting will affect the THD measurement.*

Mode: Auto, Man
 Frequency Range(3dB): 10kHz~1MHz (1-3-10 step)

N dB Bandwidth

Description N dB bandwidth measurements are used to measure the frequency bandwidth that covers a specified amplitude (N dB) from the top of the peak.

Example

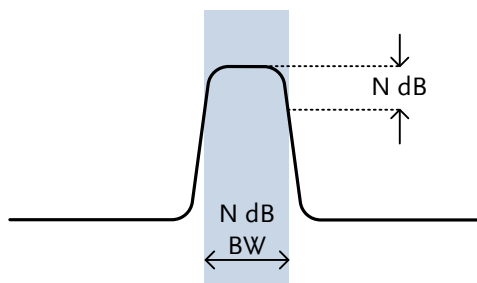

- Operation**
1. Press **Measure** > **More**[F7]>**NdB Bandwidth**[F3]>**NdB BW**[F1] and turn N dB BW on.
 - Any other measurement mode will automatically be disabled.
 2. The display splits into two screens. The top shows the trace with markers for NdB and NdB BW. The bottom screen shows the N dB measurement results in real time.

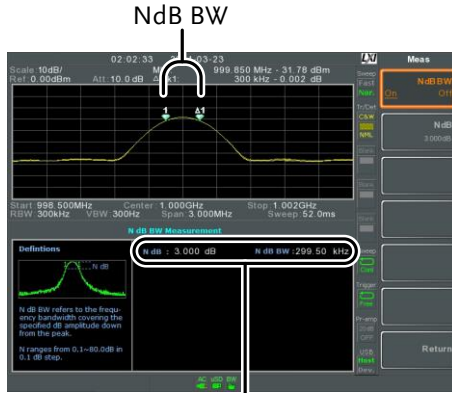

N dB BW Measurement

3. Press $NdB[F2]$ to set the NdB amplitude:

Amplitude: 0.1dB ~ 80.0 dB



Note

The NdB bandwidth measurements are strongly tied to the RBW and VBW.

P1dB Measurement

Description

The P1dB compression point describes the point at which the gain of an active DUT is 1dB less than the ideal linear gain (or small signal gain) relative to the input.

Example

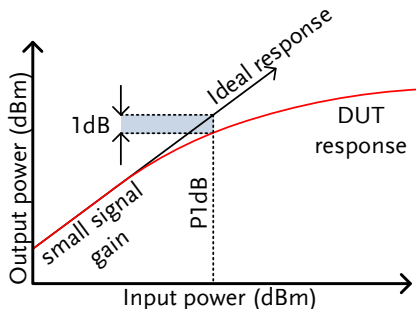

P1dB Connection Setup

Connect the DUT to the RF input. Connect the tracking generator output to the DUT input. The DC output can be used to power the DUT if necessary.

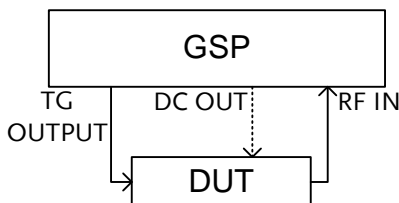

Operation

1. Press **Measure** > *More*[F7]>*P1dB*[F4]>*P1dB*[F1] and turn P1dB on.
 - Any other measurement mode will automatically be disabled.
 - It is not necessary to turn the tracking generator on.
2. The display splits into two screens. After setup has been completed (see step 3), the top shows the trace (yellow) with the ideal response in red. The P1dB measurement is shown in green. The bottom screen shows the P1dB measurement results in real time.

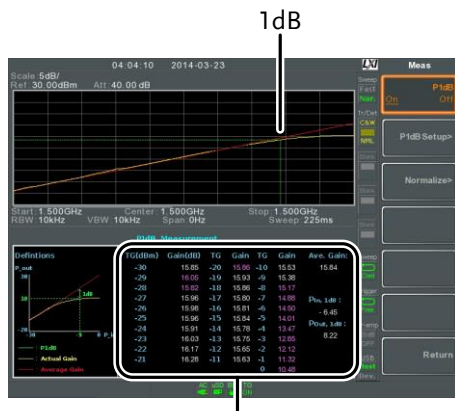

P1dB measurements

The measurement results display a total of 31 points, incremented in 1dB steps from -30dBm to 0 dBm. In each column the left side shows the input power and the right side shows the gain. Gain marked in white is effective gain, while gain marked in purple is ineffective gain. The results also list the average gain, the output power at the P1dB point ($P_{out, 1dB}$) and the input power at the P1dB point.

3. Press *P1dB Setup*[F2] to set the P1dB settings.
4. Press *Center Freq*[F1] to set the center frequency:
Frequency: 0 ~ 3.25GHz
5. Press *Gain Offset*[F2] to set the gain offset of the ideal linear response.
Gain: -99.00dB ~ 99.00 dB
6. To help smooth the actual frequency response and measure the P1dB compression point more accurately, press *Average*[F3] to set the average number. This is especially useful if *Start* is set around -50dB.
Average number: 1 ~ 200
7. Press *Start*[F4] to set the “starting” output power for the P1dB measurement.
Start: -50dB ~ -5dB
8. Press *Reset*[F5] to restart the P1dB measurement function.



If the equivalent gain exceeds 30dBm the gridicule area will be bordered in red to indicate that the input exceeds specified levels.

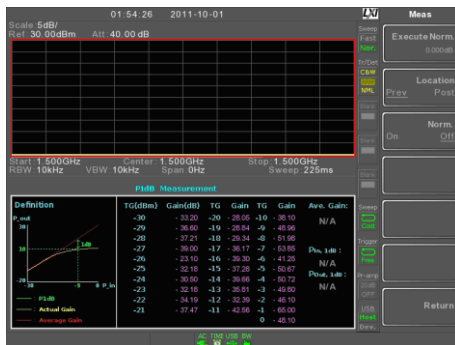

Note

The maximum power the DC output can provide is 7volts/500mA.

P1dB Normalization

Description

The normalize function is used to compensate for any loss from a long cable that may cause inaccurate measurements.

This function relies on the DUT being directly connected to either the TG or the RF input. The position of the long cable in relation to the DUT (input or output) will affect the P1dB measurement.

If the cable is at the DUT input, then the line loss of the cable will reduce the output of the TG before it is input to the DUT. This configuration (Location = Prev) can affect the position of the P1dB point if not normalized.

Likewise if the cable is connected to the output of the DUT, then the gain of the DUT will be reduced at the RF input by the line loss of the cable. In this configuration (Location = Post) the P1dB point will not be affected.



Note

If a DUT cannot be directly connected to the TG output or the RG input, try to use the shortest cable possible to reduce the effect of cable loss. The line loss from short cables cannot be measured when using the Normalize function.

Example 1

Location = PreV

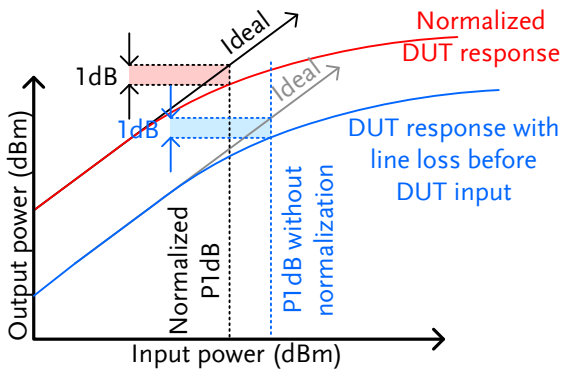

Example 2

Location = Post

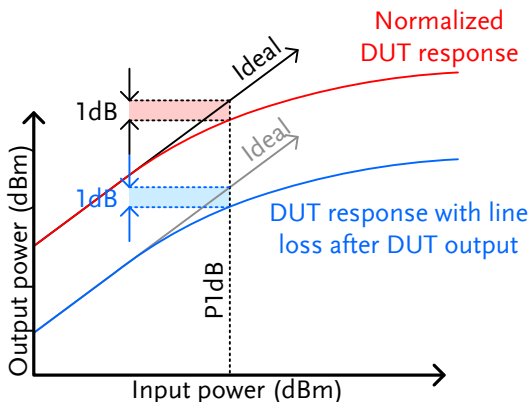

Note

This function can only be used when the P1dB is turned on.

Operation

1. Connect the cable that is to be connected to the DUT between the TG and the other cable to the RF input.

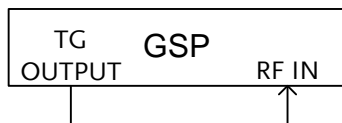

2. Press **Measure** > *More*[F7]>*P1dB*[F4] >*Normalize*[F3].
3. Press *Execute Norm*[F3]. This will normalize the cable loss. The cable loss will be shown in the *Execute Norm* icon.

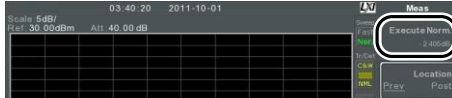

4. Next connect the DUT either directly to the TG or directly to the RF input. The location of the DUT will determine whether the cable loss is normalized before or after the DUT.

Connect the RF cable from the DUT to the either the TG or RF input, depending on where the DUT was connected.

Location = Prev

Location = Post

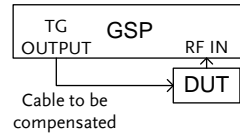
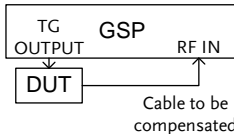

5. Set *Location*[F2] to either *PREV* or *POST*, depending on the location of the DUT, as shown above.
6. Turn *Norm.*[F3] on.
7. The cable loss will now be normalized, based on where the DUT is located.

IQ Analysis

Description IQ Analysis mode provides both 30kHz and 10kHz settings for RBW. You can capture and observe the amount of change in IQ value of signals in this mode. The maximum measurement time reaches up to one second.



Note

This mode is only applicable to software version above v3.07.



Note

This mode is only applicable to firmware version above v3.0.0.6.

Operation

1. Press  >More[F7]>Data Record[F5]>IQ Analysis[F1] and turn IQ analysis on. Any other measurement mode will automatically be disabled. Spectrum measurement is shown as the diagram below. The yellow line indicates I, while the purple on indicates Q.

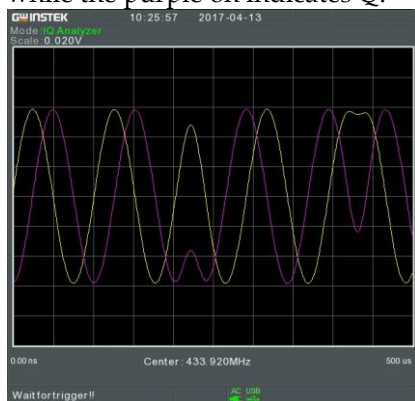

Record time

2. Press *Record Time* [F3]: Set the time interval to observe.(10us~1s) °

- Display View
3. Press *Y Axis*> [F4]: Go to the Y-axis menu
 - Ref Level*[F1] Offsets the reference position as a percentage of the vertical scale/div.
 - Ref. Pos*[F2]: Sets the reference position of the waveform on a vertical grid subdivision (1:10).
 - Scale/Div*[F3]: Sets the scale of division in Y-axis.
- AF trigger configuration
4. Press *Trigger*[F5] to set the triggering conditions:
 - Free Run*[F1] Disables the trigger, this is the default setting.
 - Trigger Condition*[F2]> *RF* -80 to +10dBm
Trigger[F1] Sets the RF trigger level:
 - Trigger Condition*[F2]> *Video Edge*[F3] Sets the video trigger slope:
Off, Pos, Neg.
 - Trigger Condition*[F2]> *Video Edge*[F4] Sets the video trigger level:
1uV ~ 5V
 - Trigger Mode*[F3] Sets the triggering mode:
Norm.: Normal trigger
Sgl.: Single trigger
Cont.: Continuously trigger
 - Trigger Delay*[F4] Sets the trigger delay time:
0 to 1ks

Action Now[F5] Turns FreeRun mode off and uses the user-defined trigger settings.

Press *Action Now[F5]* to manually trigger.



Note

The trigger icon will be replaced with the AF trigger when the AF trigger is used:



EMC Pre-Compliance Testing

The GSP-9330 EMC Pretest function is a comprehensive suite for performing, debugging or estimating radiated or conducted emissions as well as the ability to troubleshoot immunity tests.

The EMC Pretest function is divided into 5 main functions: EMI Test, Field Sensor, Source Contact Probe, AC Voltage Probe and EMS Test.

The EMI Test function is used to perform radiated or conducted emissions tests. These tests include inbuilt support for a number of EN and FCC standards to test against.

The Field Sensor functions allow you to simulate the radiated emissions at 3 meters and 10 meters for a number of different EN and FCC standards.

The Source Contact Probe function is used to debug sources of electromagnetic emissions using the GW Instek Source Contact probes. This function also allows you test against EN or FCC radiated emission standards.

The AC Voltage Probe function allows you to estimate the conducted the emissions from the power lines without having to perform conducted radiation tests with the increased cost of a LISN device. It can also be used to debug sources of conducted emissions on your DUT.

The EMS Test function allows you to debug radiated immunity (susceptibility) weakness in the DUT by outputting a source signal from the TG Output with user-defined characteristics.

- EMI Testing for Radiated Emissions → from page 202.
- Near Field Testing: Field Sensor → from page 210.
- Near Field Testing: Source Contact Probe → from page 213.
- Conducted Emissions Estimation: AC Voltage Probe → from page 216.
- Susceptibility Debugging (EMS Test) → from page 219.

EMI Test

Description The EMI Test function is used to greatly simplify the process of EMI pretesting for radiated or conductive emissions testing. You only need to specify the testing frequency, standard used and any corrective factors.

In addition, the peak table function can be used and the results can be shown logarithmically.



Note

Note the following instructions assume that you are familiar with how to conduct a radiated or conducted emissions test and are familiar with the various emissions standards.

Band A, Band B and Band A + B will judge whether the input signals of 9k ~ 30MHz frequency exceed the Ref level. If yes, a message "Power over Range" will display on the lower part of LCD screen to remind the user that input signal is too large and may damage the RF related components.

EMI Testing Overview Generally speaking, EMI testing is split into 4 different tests: radiated emissions, radiated immunity, conducted emissions and conducted immunity tests. The EMI test function is primarily concerned with radiated emissions and to a lesser extent, conducted emissions.

Radiated Emissions Tests The following is a basic overview of radiated tests. There are a number of different standards, each that have specific test configurations and methods. Most radiated tests are performed in an anechoic chamber or in an open area, where the size of the testing area and the position of the test apparatus may differ from each

standard.

An example of a possible setup is shown below.

Place the DUT and antenna on a grounding plane. Arrange the DUT on a raised non-conducting platform and position the antenna 3 or 10 meters from the DUT. Set the antenna height as specified in the applicable standard. Arrange the antenna once in the horizontal position and once in the vertical position. Rotate the DUT 45° after each test.

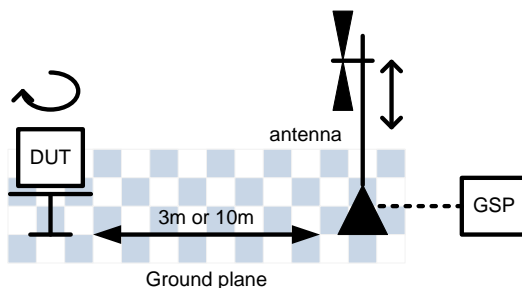

Conducted Emissions

For conducted emissions testing, a LISN (line impedance stabilization network) is required. A LISN is used for two main reasons. Firstly, it is used to filter any noise from the mains power that is fed to the DUT. Secondly, it filters RF noise from the DUT that would normally be coupled to the mains power and passes it to the spectrum analyzer.

A limiter is also usually used to attenuate the signal input to the spectrum analyzer to safe levels.

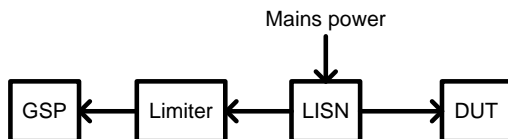

Operation

1. Press **EMC Prefest** > *EMC On*[F1] > *EMI Test*[F2] and choose a frequency band to test at. The test frequency that is chosen determines whether the test is a radiated, conducted test or user defined, based on what standard you wish to use.

EMI Test	Conducted Tests:	Radiated tests:
Frequency: 9k-150kHz,	150k-30MHz	30M-300MHz, 300M-1GHz, 30M-1GHz, 1G-3GHz.

Ambient Noise Rejection

2. Press *Amb.Noise Reject*[F2] to turn on ambient noise rejection. This function will essentially set the RBW to 9kHz and lower the noise floor for bandwidths between 30MHz and 3GHz. This will allow an open environment to emulate an anechoic chamber.

Antenna factor or LISN correction factor settings

3. Press *Correction*[F3] to apply corrective factors based on the antenna used, the LISN or the position of the antenna. The options available depend on the EMI test frequency selected previously.

None[F1]	No correction is used. Turn the Correction function off.
----------	--

Horizontal[F2] For radiated emissions tests. It is a correction set for when the antenna is in the horizontal position. This correction set is configured for use with GW Instek antennas only.

Vertical[F3] For radiated emissions tests. It is a correction set for when the antenna is in the vertical position. As with the Horizontal correction set, this correction set is configured for use with GW Instek antennas only.

Other factor[F4] Load or create a custom correction set to use with a third party antenna.

Cor.factor[F2] Load or create a custom correction set for use with a LISN device.

4. If *Other factor[F4]* or *Cor.factor[F2]* was chosen above, select a correction set or edit an existing correction set and then set *Correction[F2]* to On.

Press *Return[F7]* to return to the previous menu.

- See page 53 for details on creating or editing correction sets.

Recall Limit

5. Press *Recall Limit[F4]* to add EN55022A/B, FCC A/B or EN 55015 limit lines to the display. The limit line that is produced is matched to the selected test frequency range.

None No limit line

EN5502A Euro commercial standard

EN5502B	Euro residential standard
FCC A	American non-residential standard
FCC B	American residential standard
EN55015	Fluorescent lights/luminaries is for Band A+B only. (Only applicable to the software version above V3.07)
User Define	Customize the limit line. This function is equivalent to the related settings of original Limit line Edit & Recall. (Only applicable to the software version above V3.07)

6. Select *Average*[F1] or *Quasi-peak*[F2] or *Both*[F3] for the detector for the chosen standard. The availability of these settings depends on the EMI test frequency selected previously.

Detector: Average, Quasi-peak, Both.

7. When Recall Limit is turned on, pass/fail testing will be performed on each sweep based on the standard selected.

Pass: , with green grid border.

Fail: , with red grid border.

Display Icon



The alarm icon is shown at the bottom of the display whenever Recall Limit is turned on.

Example

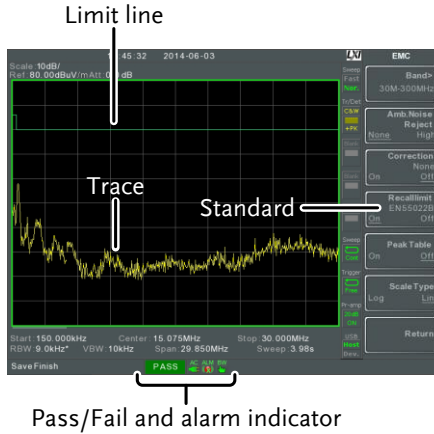

8. Press *Peak Table*[F5] to turn on the peak table function.

The peak table function will split the display and add peak markers to the top ten peaks and list them at the bottom.

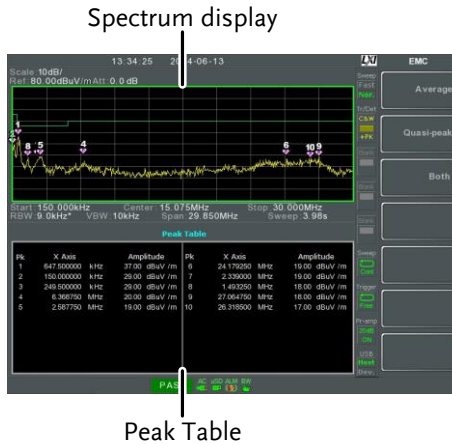

9. Press *Scale Type[F6]* to set the frequency scale to logarithmic or linear. Logarithmic frequency scaling is often used for compliance testing.
10. If any test fails, use the Field Sensor, Source Contact Probe or AC Voltage Probe functions to find the cause(s) of the test failure. Rectify the causes and then re-test.

GLN-5040A 10 dB Comp. Press *More[F6]>GLN-5040A 10 dB Comp.[F2]*. The GLN-5040A 10 dB Comp function sets an offset value to the reference level to compensate for any loss or gain from an external network or device. (Only applicable to the software version above V3.07)

ON: +10 dB

OFF: 0 dB

Limit Line Offset 12. Press *More[F6]>Limit Line Offset[F3]*. By adding a certain offset to the limit value, you can adjust the limit line so that it conforms to the device output. (Only applicable to the software version above V3.07)



QP Analysis

13. Press *More [F6]> QP Analysis> [F4]*, so that you can more accurately determine the amount of change in the signal. Originally Detection captures only the peak + (the highest value per unit time), therefore the current frequency point of the signal may be changed, QP Analysis is designed to perform Detection = QP signals measurement for nine frequency points of relatively large in signal value after Trace View. For this, you can get one more parameter of judgment.
14. Press *More[F6]>QP Analysis>[F4] >QP Analysis[F1]* to turn on QP Analysis
15. Press *More[F6]>QP Analysis>[F4] > Auto Run[F3]* .
Set the QP frequency and get the Amp value according to the peak number set by [F5] Peak Number.
16. The orange line below the Marker icon is the relative position of the Amp value after QP as shown in the diagram below. The Marker icon is the relative position of the Peak + Amp value that was originally read.

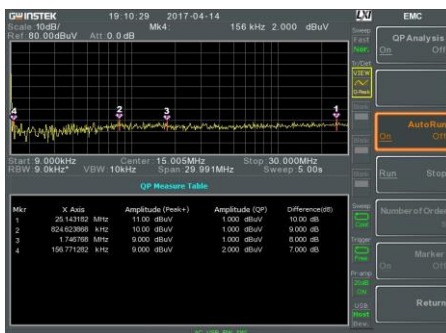

- Trace will be updated once after each run of scan. Trace Peak refreshes again, and then performs QP frequency setting and acquiring Amp value.

There will be 1 to 9 set of related information in the QP table: Frequency value of Marker icon, Peak + Amp value, QP Amp value, difference of the subtraction between Peak + and QP Amp value.

- Press *More*[F6]>*QP Analysis*>[F4] > *Run Stop*[F4] to pause F3 : Auto Run scanning function.
- Press *More*[F6]>*QP Analysis*>[F4] > *Marker*[F6] to turn on a Marker point which allow the user to operate by himself (QP Amp value data is displayed in the second area).

Near Field Testing ~ Field Sensor

Description

The Field Sensor function can be used to narrow down sources of strong magnetic fields before making a radiated compliance test as this function allows you to simulate the radiated emissions from 3 or 10 meters when using any of the GW Instek Field Sensors.

Magnetic field sources are characterized by high current, low voltage sources, such as PCB traces with high current.



Note

The 3m and 10m simulated results are based on the probe factors of the GW Instek Field Sensor antennas, and as such can only be used with a GW Instek Field Sensor.

Example Setup

With the DUT turned on, scan the DUT with the Field Sensor parallel to the DUT. The response of the probe from the DUT may fluctuate based on a number of different factors:

- The position of the probe
- The position of the DUT
- The operating state of the DUT
- The size of the probe used
- The testing frequency/bandwidth of the applied standard

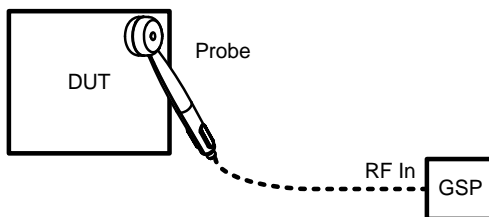

Operation

1. Press  >EMC On[F1]>Field Sensor[F3]> and choose a frequency band or user define to test at.

Field Sensor Test Frequency:	30M-300MHz, 300M-1GHz, 30M-1GHz
------------------------------	------------------------------------

Correction Set

2. Press *Correction*[F2] and choose whether to view the near-field test results as is or the simulated radiated results based on the near-field test.

None[F1]	No correction is used.
3m[F2]	Simulated 3m radiated emission based on the near field emissions.
10m[F3]	Simulated 10m radiated emissions.

Other factor[F4] Create, edit or select a correction set to use. This option is useful if a third party M-field antenna is used. See page 53 for details on creating a correction set. This option will not allow you to simulate the 3m or 10m radiated emissions.

Recall Limit

3. Press one of the limit standards to show the limit line for a standard and to start pass/fail testing. These limit lines should only be used for when the 3m or 10m correction sets are used.

EN5502A Euro commercial standard (10m)

EN5502B Euro residential standard (3m)

FCC A American non-residential standard (10m)

FCC B American residential standard (3m)

Pass/fail testing will also be performed on the simulated emissions after each sweep, based on the standard selected.

Pass:  , with green grid border.

Fail:  , with red grid border.

Display Icon



The alarm icon is shown at the bottom of the display when a standard is selected.

Example

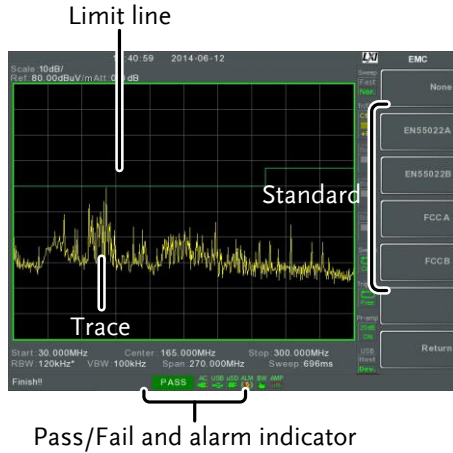

Near Field Testing ~ Source Contact Probe

Description

The Source Contact Probe function allows you to perform near field testing of electric fields (E-fields) so that you can narrow down sources of strong electric fields before compliance testing.

These types of fields are usually found on traces connected to high impedance components or on un-terminated cables or tri-state outputs from logic circuits.

Example Setup

With the DUT turned on, touch the Source Contact probe anywhere on one of the PCB traces, PCB pins, I/O cable pins or one of the other exposed conductors.

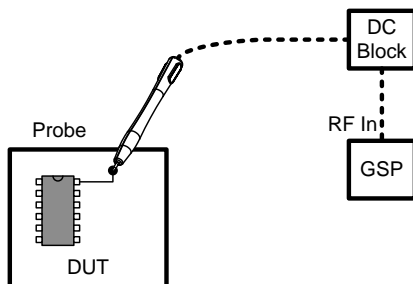

Warning

When using a Source Contact probe, please make use of a DC block or other limiter to protect the RF input of the spectrum analyzer.

Operation

1. Press **EMC Pretest** > *EMC On*[F1] > *Source Contact Probe*[F4] > and choose a frequency band or user define to test at.

Source Contact Test 30M-300MHz,
 Frequency: 300M-1GHz

2. Next select the type of e-field source that will be used with the E-field probe.

PCBtracePin[F2] For use on PCB traces/pins

I/OcablePin[F3] For use on I/O cabling/pins.



Correction Set

3. Press *Correction*[F1] and choose the length of the PCB trace/I/O cable. This will help the software to estimate the radiated emissions that would emanate from those points.

For PCBtracePIN

None[F1] No correction is used.

20cm trace[F2] For traces of approx. 20cm

	15cm trace[F3]	For traces of approx. 15cm
	10cm trace[F4]	For traces of approx. 10cm
	6cm trace[F5]	For traces of approx. 6cm
	4cm trace[F6]	For traces of approx. 4cm
For I/O Cable PIN	None[F1]	No correction is used.
	2m cable[F2]	For cables of approx. 2m
	1.5m cable[F3]	For cables of approx. 1.5m
	1m cable[F4]	For cables of approx. 1m
	0.5m cable[F5]	For cables of approx. 0.5m
Recall Limit	4.	Press one of the limit standards to show the limit line for a standard and to start pass/fail testing.
	EN5502B	Euro residential standard (3m)
	FCC B	American residential standard (3m)
		Pass/fail testing will also be performed on the simulated emissions after each sweep, based on the standard selected.
	Pass:	 , with green grid border.
	Fail:	 , with red grid border.
Display Icon		The alarm icon is shown at the bottom of the display when a standard is selected.

Example



AC Voltage Probe

Description

The AC Voltage Probe function is used to perform conducted emissions pretesting of a DUT. The unique advantage of this function is that the conducted emissions pretest can be performed without the need of a LISN.

This function is only to be used with the GW Instek EMI AC Voltage Probe (GW Instek part number PR-01).

Testing Example

To perform this test, touch the AC Voltage Probe to the Line, Neutral or Ground lines of the DUT's input power. The power must be on when this test is performed. For safety purposes a power plug adapter with a pass-through should be used.

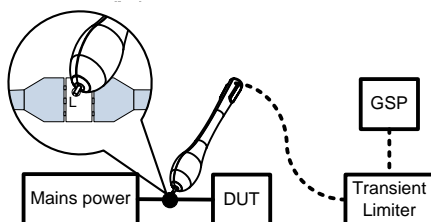



Warning

When testing the AC Voltage Probe on a line input, a power plug adapter with a pass-through to the Line, Neutral or Ground lines should be used. This adapter will allow you to safely test the input power line. This is not supplied by GW Instek and should be user-sourced.

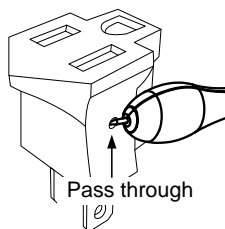

Warning

The AC Voltage Probe should only be used with general electric devices connected to mains power (AC100~240V). When testing, care must be taken to avoid conditions are not prone to lightning, flooding or other dangerous conditions.



Warning

Make sure a transient limiter or pulse limiter is used between the probe and the RF input to protect the RF input of the spectrum analyzer.

Operation

1. Press  >EMC On[F1]>AC Voltage Probe[F5]> and choose Pretest or Debug.

Pretest The pretest option is used on a live AC line. This will estimate the conducted emissions testing without the use of a LISN device. This function is only supported with the GW Instek AC Voltage Probe.

Debug Spot test potential conducted emissions on the AC power components of the DUT. This is useful to analyze the potential sources of conducted RF.

- Recall Limit
2. Press *Recall Limit*[F5] to add EN55022A/B or FCC A/B limit lines to the display. Then press one of the limit standards to show the limit line for a standard and to start pass/fail testing.

EN5502A Euro commercial standard (10m)

EN5502B Euro residential standard (3m)

FCC A American non-residential standard (10m)

FCC B American residential standard (3m)

Pass/fail testing will also be performed on the simulated emissions after each sweep, based on the standard selected.

Pass:  with green grid border.

Fail:  with red grid border.

- Scale Type
- Press *Scale Type*[F6] to set the frequency scale to logarithmic or linear. Logarithmic frequency scaling is often used for compliance testing. (Only applicable to the software version above V3.07)

- Display Icon
-  The alarm icon is shown at the bottom of the display when a standard is selected.

Example

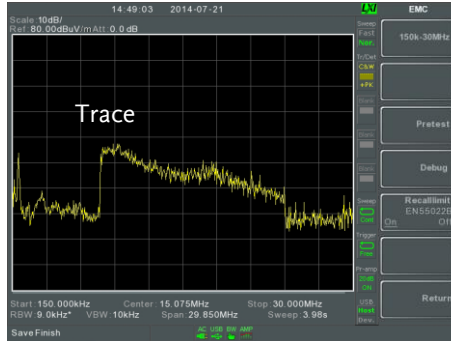

EMS Test

Description

The EMS Test function allows you to debug immunity (susceptibility) of a DUT using the GW Instek Field Sensors. The test function is designed to output a frequency sweep of a user-defined range with a user-defined signal strength.

Example Setup

The test setup is simple. Power up the DUT and scan the DUT with the probe. Observe the DUT for any abnormal response from the signal output by the probe.

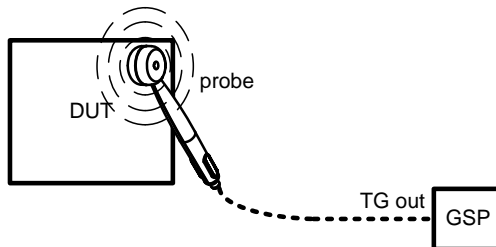

Operation

1. Press  > *EMS Test*[F6].
2. Press *80MHz-300MHz*[F3], *300MHz-1GHz*[F4] or *80MHz-1GHz*[F5] to select a pre-defined frequency range and start the sweep. Press again to stop.
3. Alternatively, press *User Define*[F6] to configure a user-defined frequency sweep range.
4. Press *SRC FreqStart*[F1] and set the start frequency of the sweep.

Start Freq. 0Hz - 3.25GHz

5. Press *SRC FreqStop*[F2] and set the stop frequency of the sweep. The stop frequency must be 100Hz greater than the start frequency.

Stop Freq. 100Hz - 3.25GHz

6. Press *Run Stop*[F3] to start the frequency sweep. Press again to stop.



Note

Frequencies are swept by 1% increase steps from the lowest to the highest value of the selected range. When the highest frequency is reached, the sweep cycle starts again from the lowest value.

7. Press *Source Strength*[F2] and set the source output power.

Power: 3V/m, 1V/m

Units: V/m

8. Press *EMS Source*[F1] and turn the source on to start testing.

9. Check to see that the DUT is operating correctly when the signal is output from the probe.

Example

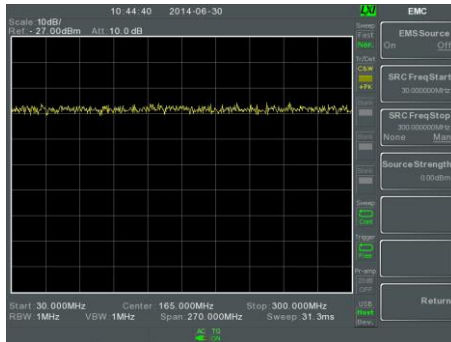

Limit Line Testing

The limit line is used to set the upper or lower amplitude limits over the entire frequency range. The limit lines can be used to detect whether the input signal is above, below or within the limit lines.

The limit lines can be manually or automatically created. The limit lines can be manually edited by frequency or from the trace data or marker points.

- Creating a Limit (Point by Point) → from page 222.
- Creating a Limit (from Trace Data) → from page 224.
- Creating a Limit (from marker data) → from page 225.
- Creating a Limit (from marker data) → from page 225
- Delete Limit Line → from page 226
- Pass Fail Testing → from page 227

Creating a Limit (Point by Point)

Description	Create a limit manually, point by point. A maximum of ten points can be used.
Operation	<ol style="list-style-type: none"> 1. Press  > <i>Edit Select Limit[F1]</i> > <i>Limit Line [F1]</i> and choose a limit line. Limit line: 1~5 2. Press <i>Point by Point[F2]</i>. <p>The GSP-9330 is split into two screens. The top screen shows the trace and limit lines and the bottom screen shows the limit line table.</p>

Spectrum display

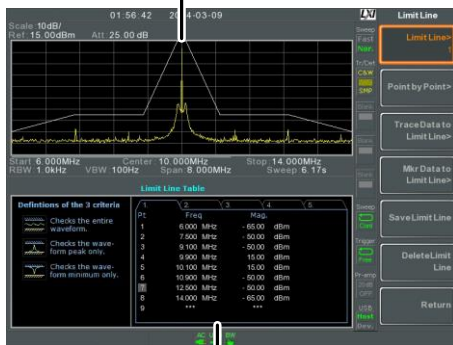

Limit Line Table

3. Press *Point Num*[F1] and choose a point number to edit with the number pad (must start at #1).
4. Press *Frequency*[F2] and set the frequency of the point.
5. Press *Limit*[F3] and set the amplitude level of the point.

All the points will be displayed in a limit line table at the bottom of the display.

6. Repeat steps 3-5 for the remaining points (maximum of 10points. Points can only be created in numerical order).
7. To delete the selected point, press *Delete Point*[F6].
8. Press *Return*[F7]>*Save Limit Line*[F5] to save the currently selected limit line.



Note

Note that the limit lines are automatically sorted by frequency (low → high).

Creating a Limit (from Trace Data)

Description Trace data can be used to create limit lines. A 10 point limit line is created from the trace data at each grid division as well as the start and stop frequencies.

- Operation**
1. Press **Limit Line** > *Edit Select Limit[F1]* > *Limit Line [F1]* and choose a limit line.
Limit line: 1~5
 2. Press *Trace Data to Limit Line[F3]*.

The GSP-9330 is split into two screens. The top screen shows the trace and limit lines and the bottom screen shows the limit line table.

Spectrum display

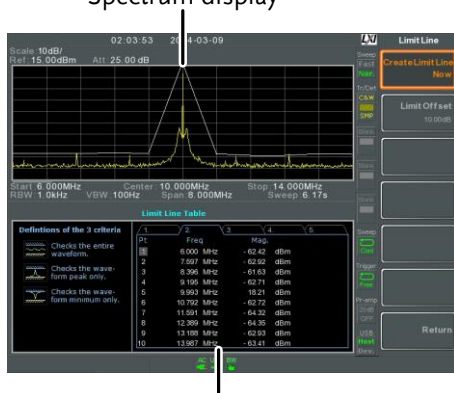

Limit Line Table

3. Press *Limit Offset[F2]* and set an offset level.
4. Press *Create Limit Line Now[F1]*.
 - A limit line will automatically be created based on the trace and offset level.

- A limit line can be created any number of times.
5. Press *Return*[F7]>*Save Limit Line*[F5] to save the currently selected limit line.

Creating a Limit (from marker data)

Description Marker data can be used to create limit lines. Please see the marker chapter on page 90 for details on markers. A maximum of 10 points can be created.

Operation 1. Press **Limit Line** > *Edit Select Limit*[F1]>*Limit Line* [F1] and choose a limit line.

Limit line: 1~5

2. Press *Mkr Data to Limit Line*[F4].

The GSP-9330 is split into two screens. The top screen shows the trace and limit lines and the bottom screen shows the limit line table.

Spectrum display

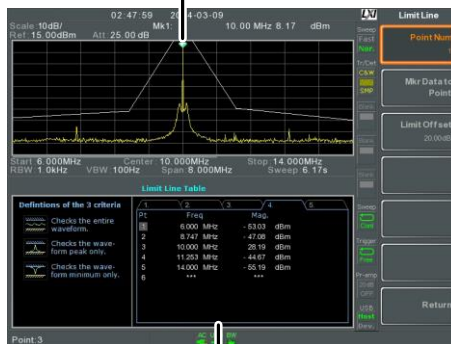

Limit Line Table

3. Press *Point Num*[F1] and choose a point number

to edit (must start at #1).

4. Press *Limit Offset*[F3] and set the offset level for the point.
 - *This will only create an offset for the currently selected point, not all the points.*
5. Press *Mkr Data to Point*[F2]. This adds the currently active marker's position to the selected point.
6. The marker position can be moved at this point using the scroll wheel. Press the Enter key to set the position.
7. Repeat steps 3-6 for any other points (max 10).
8. Press *Return*[F7]>*Save Limit Line*[F5] to save the currently selected limit line.



Note

Using this function will also change the position of marker 1 outside of the limit function.

Delete Limit Line

Description	Any one of the 5 limit lines can be deleted.
Activate Correction	<ol style="list-style-type: none"> 1. Press  > <i>Edit Select Limit</i>[F1]><i>Limit Line</i>[F1] and choose a limit line (limit line 1~5) to delete. 2. Press <i>Delete Limit Line</i>[F6]. The data from the chosen limit line will be deleted.

Pass Fail Testing

Description Before pass/fail testing can begin, limit lines for the upper and lower limits must first be saved. See page 222, 224 & 225 to save limit lines.

- Operation**
1. Press  > *Pass/Fail Test*.
 2. To set a high limit, press *High Limit[F1]* and choose one of the limit lines as the upper (high) limit.
 3. To set the low limit, press *Low Limit[F2]* and select one of the limit lines as the lower limit.
 4. Press *Pass Criterion[F3]* and select the pass criteria.

Criteria: All-In, Max-In, Min-In

5. Press *Pass/Fail Mode[F5]* to select what the GSP-9330 will do on a fail judgment. *Single* will stop testing after a single fail. *Continue* will continue testing after each fail judgment.

Pass/Fail Mode: Single, Continue

6. Press *Pass/Fail Test[F4]* and turn the testing on.
7. The test result appears in the bottom of the display, and the high and low limit lines (if enabled) appear on the display.

Pass: , with green grid border.

Fail: , with red grid border.

Display Icon



The alarm icon is shown at the bottom of the display whenever testing is turned on.

Example

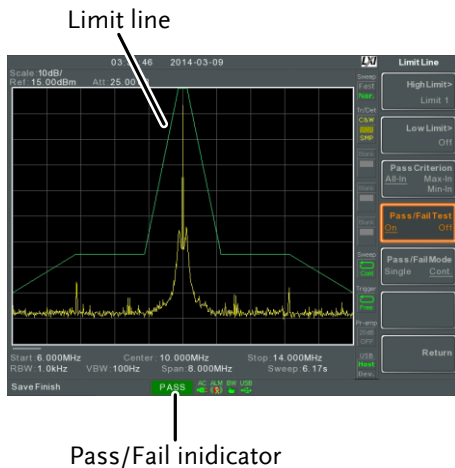

Pass/Fail indicator

 Note

At least one limit line (high or low) must be turned on to enable testing.

If the high limit or low limit is turned off, the maximum or minimum* display level is set automatically as the high or low limit, respectively.

* +30dBm+Ref level offset or -150dBm+Ref level offset



Sequence

The Sequence function records and plays back user-defined macros. There are up to 5 sequences available in repeat or single running mode, with up to 20 steps each. Delays and pauses can also be introduced into a sequence to view measurement results during a sequence. Sequences can also call other sequences to create longer sequences.

The sections below can be used to skip to the relevant section:

- Edit Sequence → from page 229
- Run Sequence → from page 233

Editing a Sequence

- Edit a Sequence
1. Press  > *Sequence[F1]* and choose a sequence to edit/create.
Sequence: 1~5
 2. Press *Edit[F2]* > *Start Edit[F1]* to start editing the selected sequence.
 3. The display splits into two screens. The top screen shows the main screen. The bottom screen shows the Sequence Editor with the sequence steps.
 - The  **Start Edit** icon appears in the sequence editor window.

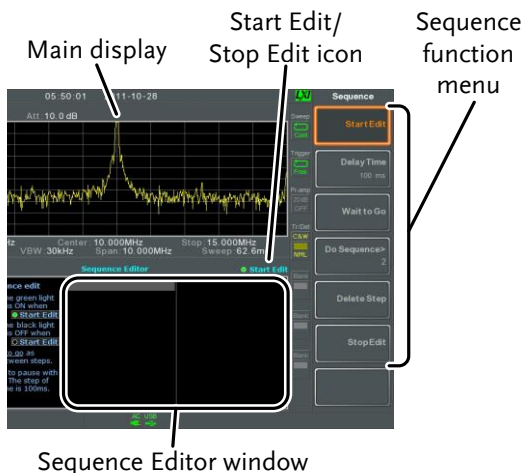

Add a Step

Up to 20 steps can be added to each sequence. Each panel operation is recorded as a step. After each panel operation is performed, press the **Enter** key to record the step (in some cases this is not necessary – check if the operation appears in the sequence editor window).

In the following example the center frequency and span are added as steps to a sequence:

1. Press **Frequency** > *Center Freq[F1]* > 20MHz > **Enter** .
2. Press **Span** > *Zero Span[F3]* > **Enter** .
3. The two operations are added to the Sequence Editor.



4. Press the **Sequence** key again to return to the sequence function menu.



Note

The arrow keys can be used to move the cursor to the desired step when in the *Sequence* menu.

Add Delay to Sequence

The delay function adds a delay between steps.

1. Press *Delay Time*[F2]> and enter the delay time.

Range: 100ms ~ 10s

2. Press  to add the delay time to the sequence editor.

- *The delay time will be inserted as a step.*

```
Center Freq: 20.000MHz
ZeroSpan
Delay Time: 500ms
```



Note

The arrow keys can be used to move the cursor to the desired step.

Pause Sequence

The Wait to Go function is used to pause a sequence until *Continue*[F1] is pressed. This is useful for observing measurements before moving onto the next step.

1. Press *Wait to Go*[F3]> .

- *Wait to Go will be inserted as a step.*

```
Center Freq: 20.000MHz
ZeroSpan
Wait to go
```

2. When a sequence is running, Press *Continue*[F1] to resume running the sequence.

Insert Sequence Inserts another sequence into the current sequence.

1. Press *Do Sequence*[F4]> and select a sequence to insert into the current sequence.
 - *The selected sequence will be inserted as a step.*

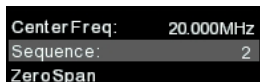

Note

The current sequence cannot be inserted into itself.

Delete Step Any step in the Sequence Editor can be deleted.

1. Use the arrow keys on the front panel to highlight the step you wish to delete.

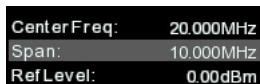

2. Press *Delete Step*[F5] > to delete the step.
 - *The selected step will be removed from the Sequence editor.*

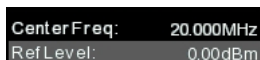

Stop Editing 1. Press *Stop Edit*[F6].

2. The  **Start Edit** icon turns off.

Save Current Sequence After a sequence has been edited (and stopped) it can be saved.

1. Press  > Save Sequence [F4] > to save the sequence.
2. The selected sequence will be saved.

Delete Current Sequence 1. Press  > Delete Sequence [F5] > to delete the current sequence.

Running a Sequence

Run Mode 1. Press  > *Sequence*[F1] and choose a sequence.

2. Press *Run Mode*[F6] and toggle the run mode:

Single Runs the sequence once only.

Cont. Runs the sequence continually until *Stop Running Sequence*[F7] is pressed (Note: the *Stop Running Sequence*[F7] option only appears when the sequence is running)

Run Sequence 3. Press *Run Now*[F7] to start running the selected sequence.

4. Press *Stop Running Sequence*[F7] to stop the sequence.

- *In single mode the sequence will stop running when all steps have finished.*

Tracking Generator

The tracking generator is a factory installed option that generates a sweep signal with its sweep time and frequency range matching the GSP-9330. The amplitude is maintained at a constant value over the entire frequency range. This is useful for testing the frequency response of a DUT.

- Activate the Tracking Generator → from page 234
- Normalize the Tracking Generator → from page 235

Activate Tracking Generator

Operation

1. Press  >Tracking Generator[F1]>TG[F1] and toggle the tracking generator on.

The TG OUTPUT will be activated.

2. Press *TG Level*[F2] to set the output level of the tracking generator.

Range: -50 to 0dBm

3. Press *TG Lvl Offset*[F3] to set the offset level of the tracking generator to compensate for system gain/loss.

Range: 0dB to 50dB

4. Press *TG Lvl Step*[F4] to set the step resolution of the TG level.

Range: Auto, Man; 0.5 to 50dB,
0.5dB step

5. Press *Power Sweep*[F5] to vary the output power of the TG to the rate of the sweep. At the beginning of the sweep, the output power is at

the set TG Level and increases/decreases linearly to the set Power Sweep level at the end of the sweep.

Range: -5dB to +5dB

Normalize the Tracking Generator

Background The normalize function subtracts the trace after each sweep with a reference trace. The resultant trace is added to a normalized reference level.

Connection When normalizing the TG output, connect the TG output directly to the RF input.

After normalization, connect the DUT to the tracking generator and connect the output of the DUT to the RF input.

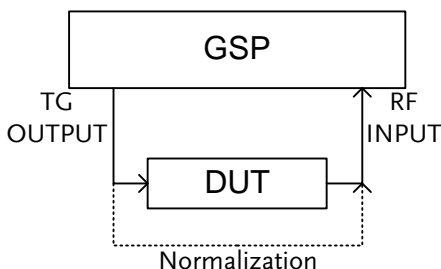

- Operation**
1. Press  > *Tracking Generator*[F1] > *TG*[F1] and toggle the tracking generator on.
 2. Press *Normalize*[F6] to enter the Normalization menu.
 3. Press *Norm. Ref. Level*[F2] to set the vertical level of the normalized reference.

Range: -100dB~100dB

4. Press *Norm. Ref. Position*[F3] offsets the normalized trace on the screen.

Range: 10~0 grid divisions.
 (top to bottom)

5. Press *Norm.[F4]* to toggle the normalized data on/off.

Alternatively, press *Exe. Norm.[F1]* to perform the normalization again.

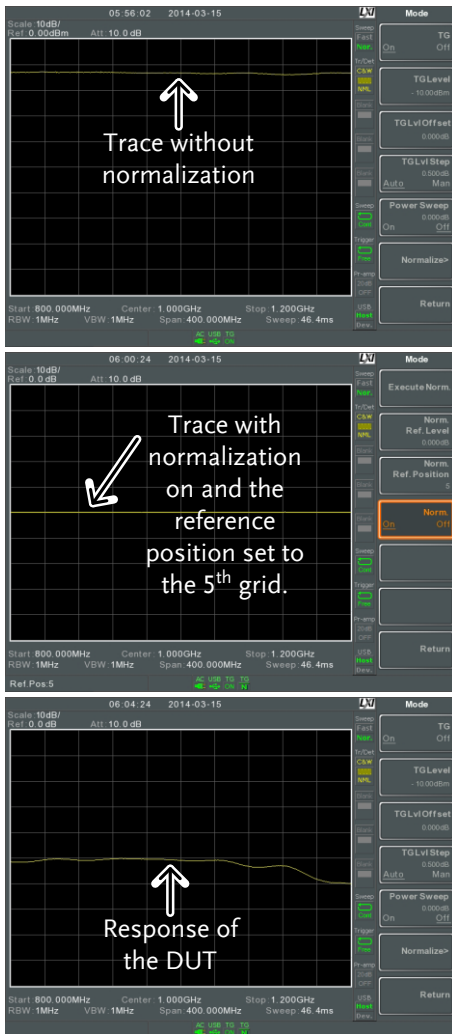

**Note**

The normalized data will be turned off automatically if any X-axis related parameters are changed or if the TG output level is changed.

The warning message, “Execute Normalization again!” will appear under these circumstances.

Power Meter

When using the optional power meter, the GSP can measure and log the average signal power level of a DUT from -32dBm ~ +20dBm over an operating frequency range of 1MHz to 6.2GHz.

- Activating Power Meter Mode → from page 239
- Data Logging Power Meter Measurements → from page 241

Activating Power Meter Mode

Connection Connect the power sensor to the front panel USB A port on the GSP-9330.

Connect the RF source to the power meter.

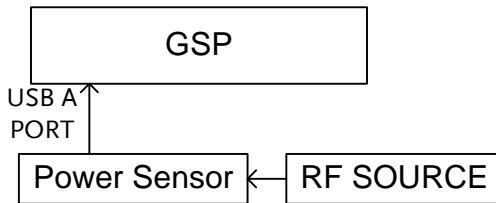

Operation 1. Press  > *Power Meter*[F2]>*Power Meter*[F1] and toggle the power meter on.

 **Note** The power meter option will not be available if the power meter is not connected properly.

2. The display splits into two screens. The top screen shows the power measurement in dBm or W. The bottom screen shows a graph of the measurements.

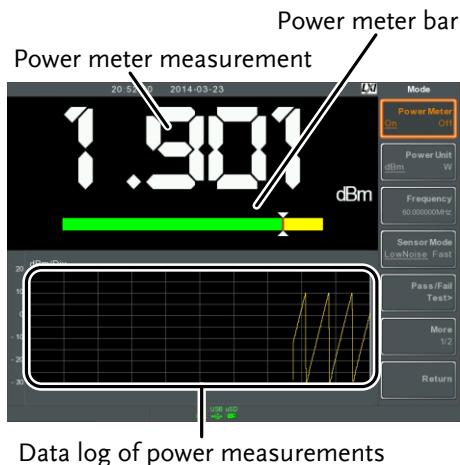

3. Press *Power Unit*[F2] and choose the unit:

Unit	dBm, W
------	--------

4. Press *Frequency*[F3] choose measurement frequency (use the number pad):

Frequency	1MHz~6200MHz
Resolution:	1MHz

5. Press *Sensor Mode*[F4] to choose measurement speed (and thus accuracy) of the power meter:

Low Noise:	100ms/sample, typical
Fast:	30ms/sample, typical

6. To create pass fail tests, press *Pass/Fail Test*[F5] and set the following parameters:

<i>High Limit</i> [F1]:	-30dBm~20dBm
<i>Low Limit</i> [F2]:	-30dBm~20dBm
<i>Pass/Fail Test</i> [F3]:	On, Off
<i>Pass Icon</i> :	PASS

Fail Icon:



- Press *More*[F6]>*Trigger*[F1] to toggle between a free run (internal) trigger and an external trigger.

Trigger: Free, Ext

Ext trigger input: 3.3V CMOS



- Press *More*[F6]> *MAX/MIN HOLD*[F2] to toggle the MAX/MIN hold measurements on/off in the power meter bar.
 - The MIN/MAX measurements will be displayed in the power bar meter in the center of the screen.*



Note

The return to the normal Spectrum Mode, turn the power meter off by pressing *Option Control* > *Power Meter*[F2]>*Power Meter*[F1] and toggle the power meter off.

Data Logging Power Meter Measurements

Description

When in Power Meter mode, the spectrum analyzer is able to log the power meter measurements over a user-defined time period at user-defined intervals.

Operation

- Press *Save* to enter the save menu.
- Press *Type*[F2] and select *Power Meter*[F7].

3. *Data Source*[F3] will automatically be set to *Power State*.

4. Press *PMET Record Option*[F4] and set the recording options:

Record Stop[F1]: Sets the recording time for automatic data logging:
 00 :00 :00 (continuous) or
 00 :00 :01 ~ 23 : 59 : 59

Record Step[F2]: 20msec ~ 999sec

5. Press *Save To*[F1] and select a destination source:

Local: Internal memory

SD Card: External micro SD card



Note

The micro SD card option will only be available when a micro SD card is inserted into the front panel port.

6. After a destination has been selected, recording options appear.

7. To name the log file, press *Name*[F1]. Name the selected file using the F1~F7 keys, as shown below or use the numeric keypad to enter numbers.

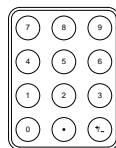

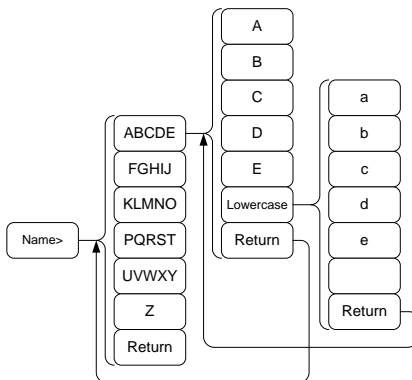

Limitations:

- *No spaces*
- *Only 1~9, A~Z, a~z characters allowed*

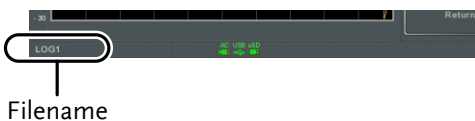

8. The filename appears on the bottom of the screen as it is created.



Press  to confirm setting the filename.



Note

If the file name is not user-defined, a file name will be automatically created in the following format:

File name: type_data source_file number.file extension

The file number parameter is incremented each time the same file type is created.

9. To start recording power meter measurements, press *Record Now*[F3].

A message “SaveFinish!!” will be displayed at the bottom of the screen when the recording has finished.

Stop Recording

To manually stop the recording, press *Record Stop*[F2].

Demo Kit

The demo kit is an ASK and FSK generator. The demo kit has three pre-set frequencies, a number of baud rates and the ability to output in normal mode, gated mode or in one of 5 selectable data sequences.

- Amplitude shift keying → from page 244.
- Frequency shift keying → from page 246.

Amplitude Shift Keying

Connection Connect the demo kit to the front panel USB A port on the GSP-9330.

Connect the demo kit output to the RF input on the GSP-9330.

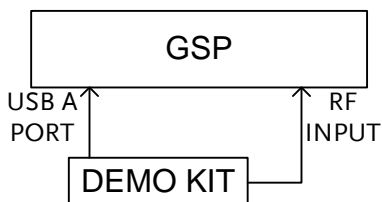

Setup 1. Press  > *Demo Kit*[F4]>*Demo Kit*[F1] and toggle the demo kit on.

 **Note**

The demo kit option will not be available if the demo kit is not connected properly.

2. Press *Modulation*[F2] and select *ASK*[F1].
3. Press *Frequency*[F3] and select the frequency:

<i>Frequency</i>	315MHz, 433MHz, 868MHz
------------------	---------------------------

4. Press *Baudrate*[F5] and select the baud:

<i>Baud</i>	4800, 9600, 20000
-------------	-------------------

5. Press *Output Mode*[F6] and select gated, normal mode or fixed data. The gated and normal modes will output random data while the fixed data option will output one of 5 pre-defined data sequences.

<i>Output mode</i>	Norm., Gated (100ms period, 16ms on, 84ms off), Fixed data.
--------------------	---

6. If fixed data was chosen for the output mode, select the data sequence.

<i>Data sequence for Fixed Data</i>	Seq1(00110101), Seq2(10100101), Seq3(00010010), Seq4(11011100), Seq5(10101010).
-------------------------------------	---



Note

The data sequence above can be decoded in the ASK/FSK demodulation function. Go to Measure>Demod>ASK/FSK>View>Symbol to see the output sequence.

Operation

The following will demonstrate how to observe the ASK signal that was generated above.

This will assume the following settings were set:

ASK modulation, frequency=315MHz,
Baudrate=4800, Output Mode=Normal

1. Press  > *Center*[F1] and set the center frequency to 315MHz.

2. Press **Span** > *Span*[F1] and set the span to 200kHz.
3. Press **Measure** > *Demod*[F2] > *ASK*[F4] and toggle ASK on.

See page 141 for setting details.

Frequency Shift Keying

Connection Connect the demo kit to the front panel USB A port on the GSP-9330.

Connect the demo kit output to the RF input on the GSP-9330.

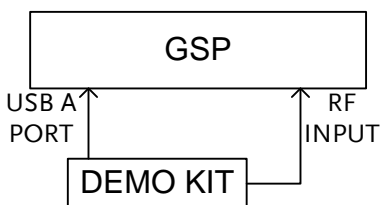

- Setup**
1. Press **Option Control** > *Demo Kit*[F4] > *Demo Kit*[F1] and toggle the demo kit on.

 **Note**

The demo kit option will not be available if the demo kit is not connected properly.

2. Press *Modulation*[F2] and select *FSK*[F2].
3. Press *Frequency*[F3] and select the frequency:

<i>Frequency</i>	315MHz, 433MHz, 868MHz
------------------	---------------------------

4. Press *Deviation*[F4] and select the frequency deviation:

Deviation 25MHz, 50MHz

5. Press *Baudrate*[F5] and select the baud:

Baud 4800, 9600, 20000

6. Press *Output Mode*[F6] and select gated, normal mode or fixed data. The gated and normal modes will output random data while the fixed data option will output one of 5 pre-defined data sequences.

Output mode Norm., Gated (100ms period, 16ms on, 84ms off), Fixed data.

7. If fixed data was chosen for the output mode, select the data sequence.

Data sequence for Fixed Data Seq1(00110101),
Seq2(10100101),
Seq3(00010010),
Seq4(11011100),
Seq5(10101010).



Note

The data sequences above can be decoded in the ASK/FSK demodulation function. Go to Measure>Demod>ASK/FSK>View>Symbol.

Operation

The following will demonstrate how to observe the FSK signal that was generated above.

This will assume the following settings were set:

FSK modulation, frequency=315MHz,
Deviation=25MHz, Baudrate=4800, Output Mode=Norm.

1. Press **Frequency** > *Center*[F1] and set the center frequency to 315MHz.
2. Press **Span** > *Span*[F1] and set the span to 200kHz.
3. Press **Measure** > *Demod*[F2] > *FSK*[F5] and toggle FSK on.

See page 148 for setting details.

FILE

File Overview

The File function is used for basic file related operations including navigation, sorting copying and deleting. The GSP-9330 has a number of different file formats for trace data, limit lines, amplitude correction, sequences and other panel operations. File source and destination locations (local, USB or micro SD) can also be chosen with the file function.

- File Type Overview → from page 250
- File Types → from page 250
- Using the File Explorer → from page 252
- Copy Files → from page 254
- Move Files → from page 255
- Delete Files → from page 256
- Rename Files → from page 257
- Save Files → from page 258
- Recall Files → from page 263
- Quick Save → from page 264

File Type Overview

Local	The GSP-9330 has 16MB of local memory to save data to.	
USB	The GSP-9330 can save to an external USB flash memory drive.	
	USB Type:	1.1/2.0 (FAT32 and NTFS formatted)
Micro SD	The GSP-9330 can save to a micro SD card.	
	Format:	SDSC, SDHC (FAT32 formatted)

File Types

Overview	The file types are listed in order as shown in the File menu.	
State	<p>State data contains the state of the each of the panel operations:</p> <ul style="list-style-type: none"> • <i>Frequency</i> • <i>Span</i> • <i>Amplitude</i> • <i>BW/AVG</i> • <i>Sweep</i> • <i>Trace</i> • <i>Display</i> • <i>Measure</i> • <i>Limit Line</i> • <i>Sequence</i> • <i>Trigger</i> • <i>Marker</i> • <i>Marker</i> ► • <i>Peak Search</i> • <i>Preset</i> • <i>System</i> 	
Trace	Trace data contains the trace data in comma separated values.	

	<ul style="list-style-type: none">• <i>Center frequency</i>• <i>Span</i>• <i>Resolution Bandwidth</i>• <i>Video Bandwidth</i>• <i>Reference Level</i>• <i>Sweep Time</i>• <i>Point number (trace data points)</i>
Screen	Contains the JPEG file of the display (800X600)
Limit Line	The limit line data contains the following in comma separated values: <ul style="list-style-type: none">• <i>Point number</i>• <i>Frequency value of point</i>• <i>Magnitude of point</i>• <i>Magnitude unit</i>
Correction	Correction data contains the following correction (line) data: <ul style="list-style-type: none">• <i>Point number</i>• <i>Frequency value of point</i>• <i>Gain offset of point</i>• <i>Unit</i>
Sequence	The sequence files contain the sequence number and step operations for that sequence. This data is not designed to be user editable.

Tracking Generator	<p>The TG data contains:</p> <ul style="list-style-type: none"> • <i>TG level</i> • <i>TG level offset</i> • <i>TG level step</i> • <i>Power sweep state and value</i> • <i>Normalized reference level</i> • <i>Normalized reference position</i> • <i>Normalized state</i>
--------------------	--

Power Meter	<p>The power meter data contains:</p> <ul style="list-style-type: none"> • <i>Date</i> • <i>Time</i> • <i>Power in dBm</i> • <i>Start time/end time</i> • <i>Step time</i>
-------------	---

Using the File Explorer

Connect External Memory	To view files on a USB flash drive or micro SD card, insert the appropriate device into the front panel port.
-------------------------	---

- Selecting files
1. Press  >File Explorer.
 2. Select memory location:

<i>Local[F1]:</i>	Internal memory
<i>USB[F2]:</i>	Front panel USB memory.
<i>SD Card[F3]:</i>	Micro SD card.

3. The up/down arrow keys or the scroll wheel can be used to move up/down the file list.



4. The left/right arrow keys can be used to move to the next/previous page of files in the file list.



Note

The USB and micro SD card options will only be available when a flash drive/SD card is inserted into the front panel ports.

View Files by Type

The file explorer can be configured to only view files of a certain type. For details on file types, please see page 250.

- Press *Type[F2]* and select a file type to view:

All	All file types can be viewed
State	View state files only
Trace	View trace files only
Screen	View screen shots only
Limit Line	View limit lines only
Correction	View correction data only
Sequence	View sequence files only
Power Meter	View power meter files only

After selecting a file type, only those types of files will be listed by the file explorer.

Sort Files Files can be sorted in ascending order by either name or by date. By default, files are sorted by name.

1. Press *Sort By*[F3] and choose the sorting type:

Name: Sort by alphabetical order

Date Sort by file creation date

Preview Image Files Image files can be previewed on the screen by enabling the preview function.

1. Press *More*[F7]>*Preview*[F2] and toggle preview on or off.

Example



 **Note**

When Preview is turned on, other file types will not be viewable.

Copy Files

Description Files from local memory can be copied to external memory such as a USB flash drive or micro SD card and vice versa.

Connect External Memory	Insert either a USB flash drive or micro SD card into the front panel ports.
-------------------------	--

- | | |
|-----------------|--|
| Selecting files | <ol style="list-style-type: none"> 1. Press  >File Explorer. 2. Select a file from local or external memory. 3. Press <i>Copy to</i>[F4]. 4. Press <i>Media</i> [F1] and select the destination to copy to (local, USB, SD card). 5. Press <i>Copy Now</i> [F2]. 6. The file is copied to the destination directory. |
|-----------------|--|
-

 Note	The USB and micro SD card options will only be available when a flash drive/SD card is inserted into the front panel ports.
---	---

Move Files

Description	Files from local memory can be moved to external memory such as USB or micro SD card and vice versa.
-------------	--

Connect External Memory	Insert either a USB flash drive or micro SD card into the front panel connectors.
-------------------------	---

- | | |
|-----------------|---|
| Selecting files | <ol style="list-style-type: none"> 1. Press  >File Explorer. 2. Select a file from local or external memory. 3. Press <i>More</i>[F7] > <i>Move to</i>[F1] . 4. Press <i>Media</i> [F1] and select the destination to move to (local, USB, SD card). |
|-----------------|---|
-

5. Press *Move Now* [F2].
6. The file is moved to the destination.



Note

The USB and micro SD card options will only be available when a flash drive/SD card is inserted into the front panel ports.

Delete Files

Description	Any files in local memory or external memory such as USB or micro SD card can be deleted.		
Connect External Memory	To delete files on a USB flash drive or micro SD card, insert the appropriate device into the front panel port.		
Delete File	<ol style="list-style-type: none"> 1. Press  >File Explorer. 2. Select a file from local or external memory. 3. Press <i>Delete</i>[F5]. 4. Press <i>Delete Now</i>[F1]. 5. By default you will be asked to confirm any files marked for deletion. Choose No[F1] to cancel or Yes[F2] to confirm the deletion. 		
Delete Warning	<ol style="list-style-type: none"> 1. To disable the prompt to confirm the deletion of a file, press <i>Delete Warning</i>[F2] and select an option: <table style="margin-left: 20px; border: none;"> <tr> <td style="padding-right: 20px;">Don't Ask</td> <td>The user won't be prompted to confirm when a file is deleted.</td> </tr> </table> 	Don't Ask	The user won't be prompted to confirm when a file is deleted.
Don't Ask	The user won't be prompted to confirm when a file is deleted.		

Ask	Will prompt for the user to confirm whether to delete the file or not.
-----	--



Note

The USB and micro SD card options will only be available when a flash drive/SD card is inserted into the front panel ports.

Rename Files

Description	Any files in local memory or external memory such as USB or micro SD card can be renamed.
-------------	---

Connect External Memory	To rename files on a USB flash drive or micro SD card, insert the appropriate device into the front panel ports.
-------------------------	--

Rename File	<ol style="list-style-type: none"> 1. Press  >File Explorer. 2. Select a file from local or external memory. 3. Press <i>Rename</i>[F6]. 4. Rename the selected file using the F1~F7 keys, as shown below or use the numeric keypad to enter numbers:
-------------	---

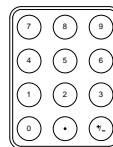

Limitations:

- *No spaces*
- *Only 1~9, A~Z, a~z characters allowed*

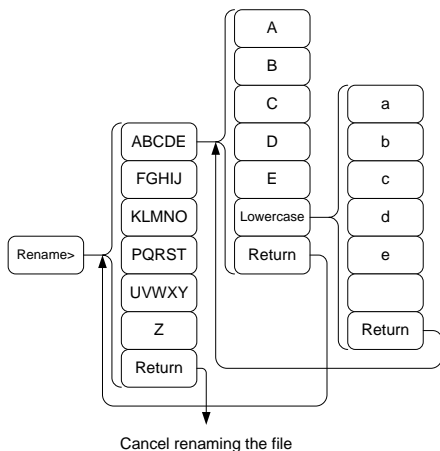

- The filename appears in the list as it is renamed.

Filename

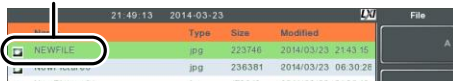

- Press to confirm the renaming of the file.



The USB and micro SD card options will only be available when a flash drive/SD card is inserted into the front panel ports.

Save Files

Description Any function settings or configurations that have been applied to the spectrum analyzer can be saved using the key.

Connect External Memory To save files on a USB flash drive or micro SD card, insert the appropriate device into the front panel ports.



Note

To save power meter data (data logging) please see page 241. Saving power meter data will not be described in this chapter.

Save File

1. Press  to enter the Save menu.
2. Press *Type[F2]* and select a file type to save. See page 250 for details on file types:

State:	State data
Trace:	Trace data
Screen:	Screen shots
Limit Line:	Limit line data
Correction:	Correction data
Sequence:	Sequence files
Power meter	Power meter data* *see page 241 for details.
A/FSK	A/FSK data
IQ	IQ data

3. Press *Data Source[F3]* to select a data source for the file type if possible:

For state data:	Local state data (fixed, not selectable)
For trace data:	Trace1~4
For screen shots:	Normal: Screen shot is saved as is Save Toner: inverts the image file color to reduce ink when printing.
For limit line:	Limit line 1~5

- For correction: Correction data 1~5
- For sequence: Sequence 1~5
- For power meter: Power state*
*see page 241 for details.
- For A/FSK ALL : Save Symbol and Trace
Symbol : Save Symbol only
Trace : Save Trace only
- For IQ IQ data

4. For trace data, press Format[F4] to select the format type to save:

- Trace: Save trace data only
- Trace+State: Save trace and state data

5. Press *Save To*[F1] and select a destination source:

- Register 1~6: Internal memory registers, these internal registers are not part of local memory
- Local: Internal memory
- USB: External memory
- SD Card: External micro SD card

6. After a destination has been selected, the file can be named or saved immediately.

7. To name the selected file, press *Name*[F5]. Name the selected file using the F1~F7 keys, as shown below or use the numeric keypad to enter numbers.:

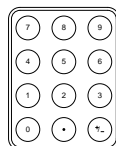

Limitations:

- No spaces
- Only 1~9, A~Z, a~z characters allowed

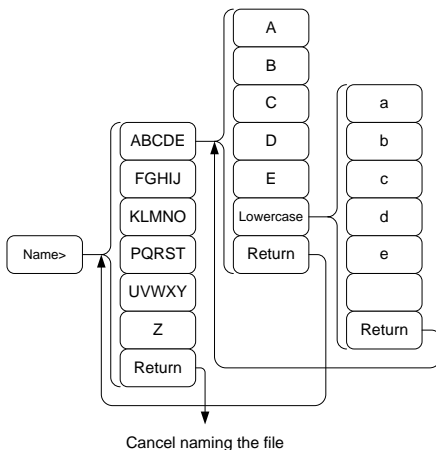

8. The filename appears on the bottom of the screen as it is created.



9. Press to confirm the naming of the file.



If the file name is not user-defined, a default naming scheme will be used. See the note below for details.

10. To save the selected file type, press *Save Now*[F7].

A message "SaveFinish!!" will be displayed at the bottom of the screen when the save is successful.



Note

When the file type is A / FSK, F7 soft key will display as Record Stop [7] on pressing Save Now [F7]. When the data is saved, press Record Stop [7] to finish saving and the display on the soft key will change back to Save Now [F7].



Note

If the file name is not user-defined, a file name will be automatically created in the following format for data files:

File name: Type_data source_XX.file extension

The image file names will be automatically created in the following format:

File name: QuickJpgX.jpg

The X parameter is incremented each time the same file type is created.



Note

The USB and micro SD card options will only be available when a flash drive/SD card is inserted into the front panel ports.

*The power meter option will only be available if the power meter option is plugged in. See the Power Meter section on page 239 for power meter details.

Recall Files

Description Most files that have previously saved a setting or state can be recalled using the  key. The exception to this are the data logging settings, see page 239.

Connect External Memory To recall files from a USB flash drive or micro SD card, insert the appropriate device into the front panel ports.

1. Press  to enter the Recall menu.
2. Press *Type*[F2] and select a file type to recall. See page 250 for details on file types:

State:	State data
Trace:	Trace data
Limit Line:	Limit line data
Correction:	Correction data
Sequence:	Sequence files
3. Press *Destination*[F3] to select the destination for the file type if possible:

For State data:	Local state data (fixed, not selectable)
For Trace data:	Trace1~4
For Limit Lines:	Limit line 1~5
For Correction:	Correction data 1~5
For Sequence:	Sequence 1~5

- Recall File
1. Press *Recall From*[F1] and select a source location:

Register 1~6:	Internal memory registers, these internal registers are not part of local memory
Local:	Internal memory
USB	External USB memory
SD Card:	External micro SD card
 2. To Recall the selected file type, press *Recall Now*[F4].
 3. A message "Finish!!" will be displayed at the bottom of the screen when the recall is successful.
-





Note

The USB and micro SD card options will only be available when a flash drive/SD card is inserted into the front panel ports.



Quick Save

Description

The  key is a hot key to save files with a single press.

The type of file that is saved is pre-configured with the  key.

By default, the  the key will save screen shots to the local memory or to an external flash drive (if inserted).

Supported File Types	Screen, trace, state, limit line, correction, sequence, power meter*. *power meter accessory must first be installed before it can be saved.
Connect External Memory	To save files to a USB flash drive or micro SD card, insert the appropriate device into the front panel ports.
Quick Save Setup	1. Press the  key and configure the file Type, Data Source and Format. See page 258 for details.
Using the Quick Save key	1. Press  at any time to save the selected file type using the settings above. 2. A “Save Finish!!” message will be shown at the bottom of the screen when the save has been completed.



Note

The file name will be automatically created in the following format for data files:

File name: Type_data source_XX.file extension

The image file names will be automatically created in the following format:

File name: Quickjpg_XX.jpg

The XX parameter is incremented each time the same file type is created.



Note

The USB and micro SD card options will only be available when a flash drive/SD card is inserted into the front panel ports.

REMOTE CONTROL

This chapter describes basic configuration of IEEE488.2 based remote control. For a command list, refer to the programming manual, downloadable from the GW Instek website, www.gwinstek.com

Interface Configuration	267
Configure to USB Remote Interface.....	267
Configure GPIB Interface.....	267
Configure the LAN and LXI Interface.....	268
Configure the WLAN Interface	271
Configure RS232C	275
RS232C Remote Control Function Check	275
LXI Browser Interface and Function Check	276
GPIB/LAN/USB Control Function Check.....	280

Interface Configuration

Configure to USB Remote Interface

USB configuration	PC side connector	Type A, host
	GSP side connector	Rear panel Type B, slave
	Speed	1.1/2.0 (full speed/high speed)
	USB Class	USB TMC (USB T&M class)

- Panel operation
1. Connect the USB cable to the rear panel USB B port. 
 2. Press **System** > *More*[F7]>*RmtInterface Config*[F1]>*USB Mode* and toggle the USB mode to *Device*.



It may take a few moments to switch USB modes.

Configure GPIB Interface

To use GPIB, the optional GPIB port must be installed.

- Configure GPIB
1. Ensure the spectrum analyzer is off before proceeding.
 2. Connect a GPIB cable from a GPIB controller to the GPIB port on the spectrum analyzer. 
 3. Turn the spectrum analyzer on.

4. Press System >More[F7]>RmtInterface
Config[F1]>GPIB Addr[F1] and set the GPIB
address.

GPIB address 0~30

GPIB constraints *Maximum 15 devices altogether, 20m cable length,
2m between each device*

Unique address assigned to each device

At least 2/3 of the devices turned On

No loop or parallel connection

Configure the LAN and LXI Interface

The GSP-9330 is a class C LXI compliant instrument. The LXI specification allows instrumentation to be configured for remote control or monitoring over a LAN or WLAN. The GSP-9330 also supports HiSlip. HiSlip (High-Speed LAN Instrument Protocol) is an advanced LAN based standard for 488.2 communications.

For details on the LXI specification, compliance classes and HiSLIP, please see the LXI website @ <http://www.lxistandard.org>.

Background The LAN interface is used for remote control over a network. The spectrum analyzer supports DHCP connections so the instrument can be automatically connected to an existing network. Alternatively, network settings can also be manually configured.

LAN configuration Settings	IP Address Subnet Mask DHCP on/off	Default Gateway DNS Server
----------------------------	--	-------------------------------

Connection Connect an Ethernet cable from the network to the rear panel LAN port.



Settings

1. Press  > More[F7] > RmtInterface[F1] > LAN[F2] > LAN Config[F1] to set the LAN settings:
 - IP Address[F1]* Sets the IP address.
 - Subnet Mask[F2]* Sets the subnet mask.
 - Default Gateway[F3]* Sets the default gateway.
 - DNS Server[F4]* Sets the DNS server address
 - LAN Config[F5]* Toggles the LAN configuration between DHCP and manual settings.

Hint: Use dotted decimal notation when entering IP addresses, ie., 172.16.20.8
2. Press *Apply[F6]* to confirm the LAN configuration settings.

Display Icon



The LXI icon turns green when connected to a LAN and will flash if the “Identification” setting is on, see page 276.

Set Password

The password on the LXI webpage can be set from the spectrum analyzer. The password is shown in the system information.

By default the password is set to: lxiWNpwd

1. Press  > More[F7] > RmtInterface Config[F1] > LAN[F2] > LXIPassword[F3] to set the password.
2. Enter the password using the F1~F7 keys, as shown below, or use the numeric keypad to enter numbers:

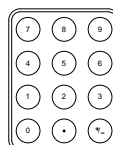

Limitations:

- No spaces
- Only 1~9, A~Z, a~z characters allowed

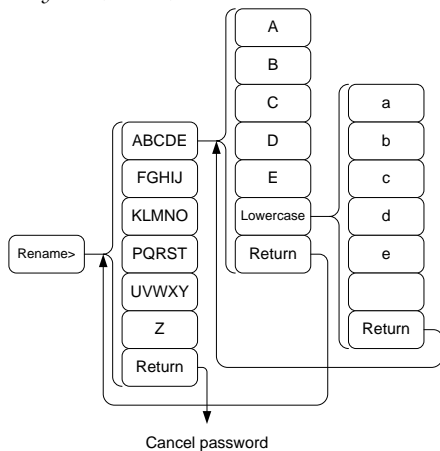

Menu tree to enter the password

3. The password appears on the bottom of the screen as it is created.

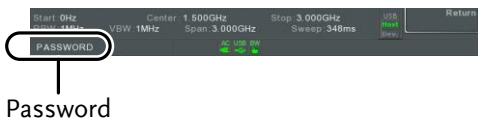

4. Press **Enter** to confirm setting the password.

Hi SLIP Port

1. Press **System** >More[F7]>RmtInterface Config[F1]>LAN[F2] >HiSLIPPort to see the Hi Slip Port number.
HiSlip port 4880

Reset LAN It may be necessary to reset the LAN configuration settings before the LAN can be used.

1. Press  >More[F7]>RmtInterface Config[F1]>LAN Reset[F3] to reset the LAN.
2. It may take a few moments before the LAN is reset.



Note

Each time the LAN is reset, the default password is restored.

Default password: lxiWNpwd

Configure the WLAN Interface

The WLAN settings operate using any standard 3G USB modem. For remote locations, using a 3G modem allows you to access the GSP-9330 web server or to control the GSP-9330 via remote control commands.



Background To use the GSP-9330 as a server using a 3G modem, you must first obtain a fixed IP address from a network provider. Each provider will assign different fixed IP addresses.

WLAN configuration Settings	IP Address Subnet Mask	Default Gateway DNS Server
-----------------------------	---------------------------	-------------------------------

Connection Connect the 3G USB modem to the front panel USB A port.

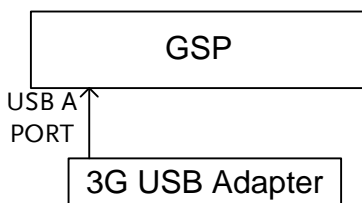
The 3G status icon  will appear when the 3G USB adapter is connected. When it is first connected it will be grayed-out to indicate that it is connected but not activated.



- Settings**
1. Insert the 3G USB modem into the front panel USB A port and wait for the 3G USB  icon to appear.
 2. Press  > More[F7] > RmtInterface[F1] > LAN[F2] > WLAN Config[F2] > Apply[F6] and wait for the 3G USB modem to establish the WLAN settings.

"Finish!!", is shown when the configuration is complete.
 3. The network settings will be displayed in the System menu icons.

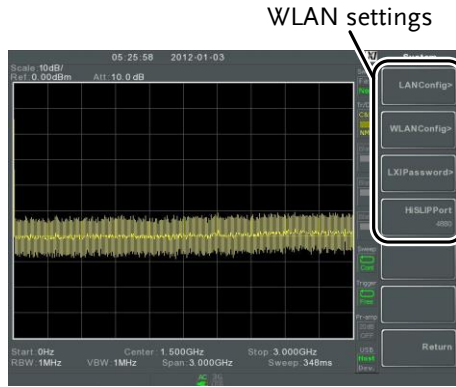

Display Icon



The 3G USB icon turns green when a successful connection has been made.

Set Password

The password on the LXI webpage can be set from the spectrum analyzer. The password is shown in the system information.

By default the password is set to: lxiWNpwd

4. Press **System** > More[F7] > RmtInterface Config[F1] > LAN[F2] > LXIPassword[F3] to set the password.
5. Enter the password using the F1~F7 keys, as shown below, or use the numeric keypad to enter numbers:

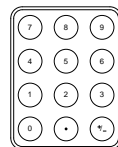

Limitations:

- No spaces
- Only 1~9, A~Z, a~z characters allowed

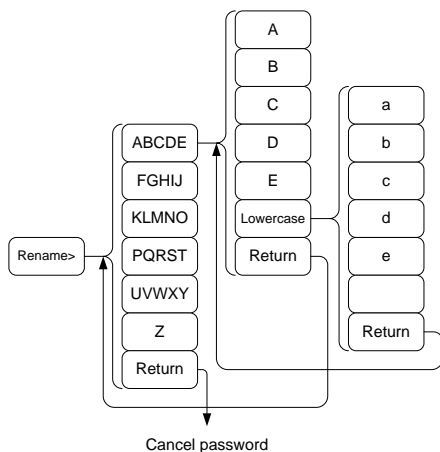

Menu tree to enter the password

- The password appears on the bottom of the screen as it is created.



- Press **Enter** to confirm setting the password.

Hi SLIP Port

- Press **System** > More[F7] > RmtInterface Config[F1] > LAN[F2] > HiSLIPPort to see the Hi Slip Port number.

HiSlip port 4880

Reset LAN

It may be necessary to reset the LAN configuration settings before the LAN can be used.

- Press **System** > More[F7] > RmtInterface Config[F1] > LAN Reset[F3] to reset the LAN.

10. It may take a few moments before the LAN is reset.



Note

Each time the LAN is reset, the default password is restored.

Default password: lxiWNpwd

Configure RS232C

Background The RS232C interface is used for remote control with a PC.

RS232C Configuration settings	Baud Rate	Stop bit: 1 (fixed)
	Parity: none (fixed)	Data bit: 8 (fixed)

Connection Connect an RS232C cable from the PC to the rear panel RS232 port.

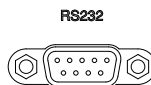

- Press  > More[F7] > RmtInterface Config[F1] > RS232 BaudRate[F4] to set the baud rate.

300	600	1200
2400	4800	9600
19200	38400	57600
115200		

RS232C Remote Control Function Check

Functionality check Invoke a terminal application such as Realterm.

To check the COM port No, see the Device Manager in the PC. For WinXP; Control panel → System → Hardware tab.

Run this query command via the terminal after the instrument has been configured for RS232 remote control (page 275).

*idn?

This should return the Manufacturer, Model number, Serial number, and Firmware version in the following format.

- *GWINSTEK,GSP9330,XXXXXXXXX,V3.X.X.X*

Manufacturer: GWINSTEK

Model number : GSP9330

Serial number : XXXXXXXX

Firmware version : V3.X.X.X



Note

For further details, please see the programming manual, available on the GW Instek web site @ www.gwinstek.com.

LXI Browser Interface and Function Check

Functionality
check

Enter the IP address of the spectrum analyzer in a web browser after the instrument has been configured and connected to the LAN (page 268) or WLAN (page 271).

`http:// XXX.XXX.XXX.XXX`

The web browser interface appears:

Welcome Page

The Welcome Page lists all the LXI and LAN/WLAN configuration settings as well as the instrument identification. The instrument identification can be disabled from this page.

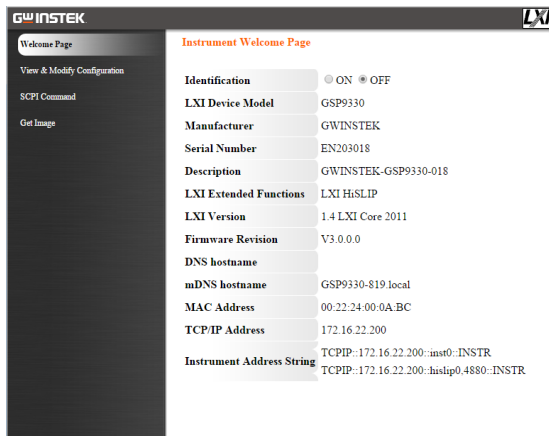

 Note



The LXI icon on the GSP-9330 display will flash when the Identification setting is turned on.

View & Modify Configuration

The View & Modify Configuration allows you to modify the LAN settings from the browser.

Press the *Modify Configuration* button to modify any of the configuration files.

A password must be entered to alter the settings.

Default password: lxiWNpwd
 [Note: password is case sensitive.]

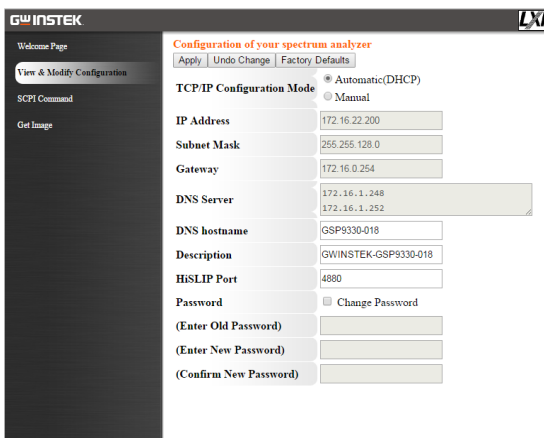

Note

If the “Factory Defaults” option is chosen, the password will be reset back to the default password

It will also be necessary to manually reset the spectrum analyzer when a message prompts you to do so on the web browser.

SCPI Command

The SCPI Command page allows you to enter SCPI commands directly from the browser for full remote control. Please see the programming manual for details. A password must be entered before remote commands can be used.

Default password: lxiWNpwd

[Note: password is case sensitive.]

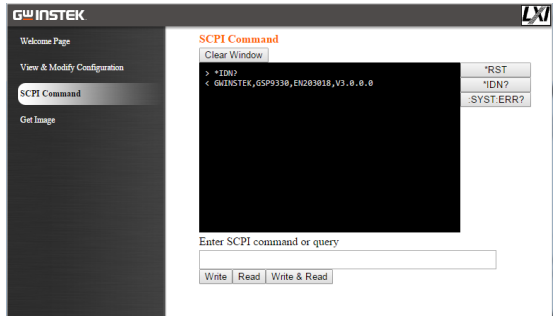

Get Image

The Get Image page allows the browser to remotely capture a screenshot of the GSP-9330 display.

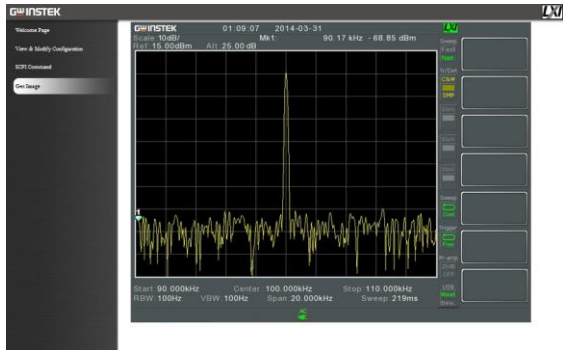

Note

For further details, please see the programming manual, available on the GW Instek web site @ www.gwinstek.com.

GPIB/LAN/USB Control Function Check

Functionality
check

Please use the National Instruments
Measurement & Automation Controller
software to confirm GPIB/LAN functionality.

See the National Instrument website,
<http://www.ni.com> for details.



Note

For further details, please see the programming
manual, available on the GW Instek web site @
www.gwinstek.com.

F FAQ

-
- I connected the signal but it does not appear on screen.
 - I want to see which optional items are installed.
 - The performance does not match the specification

I connected the signal but it does not appear on screen.

Run Autoset and let the GSP-9330 find the best display scale for your target signal. Press the Autoset key, then press Autoset[F1]. For details, see page 62.

I want to see which optional items are installed.

Check the optional items in the system information window. Press the System key → System Information[F1]. For details, see page 115.

The performance does not match the specification.

Make sure the device is powered On for at least 45 minutes, within +20°C~+30°C. This is necessary to stabilize the unit to match the specification.

For more information, contact your local dealer or GWInstek at www.gwinstek.com / marketing@goodwill.com.

APPENDIX

Replace the Clock Battery

Background

The system clock and wake-up clock keep time using a button battery.

Battery type:

CR2032, 3V, 210mAh

Connection

1. Turn off the GSP-9330 and remove the battery cover and battery (if connected).

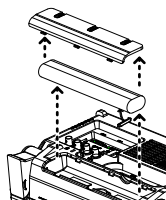

2. Replace the battery with the same type and specification.

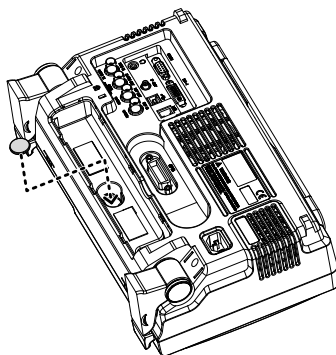

Glossary of Acronyms

Acronym	Definition
2FSK	Binary Frequency Shift Keying
3GPP	3 rd Generation Partnership Project
ACPR	Adjacent Channel Power Ratio
BS	Base Station
CF	Center Frequency
CH BW	Channel Bandwidth
CH SPC	Channel Space
CISPR	International Special Committee on Radio Interference
CNR	Carrier to Noise Ratio
CSO	Composite Second Order
CTB	Composite Triple Beat
DANL	Displayed Average Noise Level
Def.	Default
DL	Down Link
DSSS-OFDM	Direct Sequence Spread Spectrum- Orthogonal Frequency Division Multiplexing
EMC	Electromagnetic Compatibility
EMI	Electromagnetic Interference
EMS	Electromagnetic Susceptibility
ERP-CCK	Extended Rate Physical layer- Complimentary Code Keying
ERP-DSSS	Extended Rate Physical layer- Direct Sequence Spread Spectrum
ERP-OFDM	Extended Rate Physical layer- Orthogonal Frequency Division Multiplexing
ERP-PBCC	Extended Rate Physical layer- Packet Binary Convolutional Code
ETSI	European Telecommunications Standards Institute
FDD	Frequency-Division Duplexing
IF	Intermediate Frequency
HiSLIP	High Speed LAN Instrument Protocol
LOI	Local Oscillator
LPF	Low Pass Filter
LXI	LAN eXtensions for Instrumentation
OCBW	Occupied Channel Bandwidth

PSD	Power Spectral Density
P1dB	One-dB compression point
RBW	Resolution Bandwidth
REF	Reference
SEM	Spectrum Emission Mask
SINAD	Signal to Noise and Distortion Ratio
TDD	Time-Division Duplexing
TG	Tracking Generator
TOI	Third Order Intercept
UE	User Equipment
UP	Up Link
VBW	Video Bandwidth

GSP-9330 Default Settings

The following default settings are the factory configuration settings for the spectrum analyzer (Function settings/Test settings).

Frequency		
Center Frequency: 1.625GHz	Start Frequency: 0Hz	
Stop Frequency: 3.25GHz	CF Step: Auto	
Frequency Offset: 0Hz		
Span		
Span: 3.25GHz		
Amplitude		
Reference level: 0.00dBm	Attenuation: Auto	
Scale Div: 10	Scale: Off	
Y Axis: dBm	Scale Type: Log	
Reference level offset: 0.00dBm	Correction: Off	
Input Z: 50Ω	Input Z calibration: 6.000dB	
Preamp: Bypass		
Autoset		
Amp.Floor: Auto	Span: Auto	
BW/AVG		
RBW: Auto	VBW: Auto	
VBW/RBW: N/A	Average: Off	
Average Power: Log Power	EMI Filter: Off	
Sweep		
Sweep Time: Auto	Sweep: Continuous	
Gated Sweep Mode: Off	Gate Delay: 50ms	
Gate Length: 540ms	Sweep Control: Norm	
Trace		
Activated traces: trace 1	Trace Type: Clear and Write	
Trace Math: Off	Detection: Auto, Normal	
Display		
Window Setup: Spectrum	LCD Brightness: Hi	
LCD Backlight: On	Display Line, -50.0dBm, Off	

Meas		
All measurement functions: Off		
EMC Pretest		
All EMC test functions: Off		
Limit Line		
Limit lines: Off	Pass/Fail Test: Off	
Trigger		
Free Run	Trigger Condition: Video	
Trigger Mode: Norm.	Trigger Delay: 50ms	
File		
Type: All	Sort by: Name	
Quick Save		
Type: Screen	Data Source:Normal	
Save		
Type: Screen	Data Source:Normal	
Recall		
Type: State	Destination: Local State	
Marker		
Marker: Off	Data Source:Normal	
Marker▶		
N/A		
Peak Search		
Peak Track: Off	Peak Excursion: 3dB	
Peak Threshold: -50dBm	Peak Table: Off	
Mode		
Mode: Spectrum		
Sequence		
Sequence Off		
Option Control		
Tracking Generator: Off	Power Meter: Off	
System		
Language: region dependent	Power On: Preset	
Preset Type: Factory Preset	Alarm Output: Off	
Remote Interface Config		
GPIB Address: 3		
LAN: DHCP		
LXI Password: lxiWNpwd		
HiSPIP Port:4880		
RS232 BaudRate: 115200		
USB Mode: Host		

Menu Tree

Amplitude

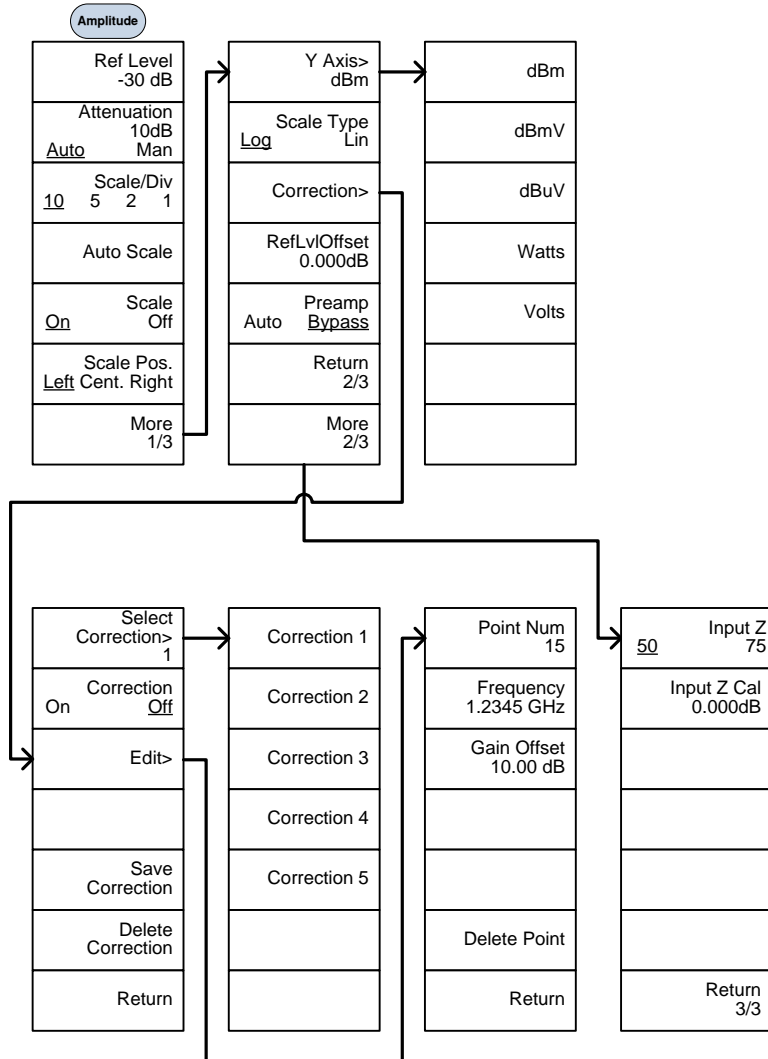

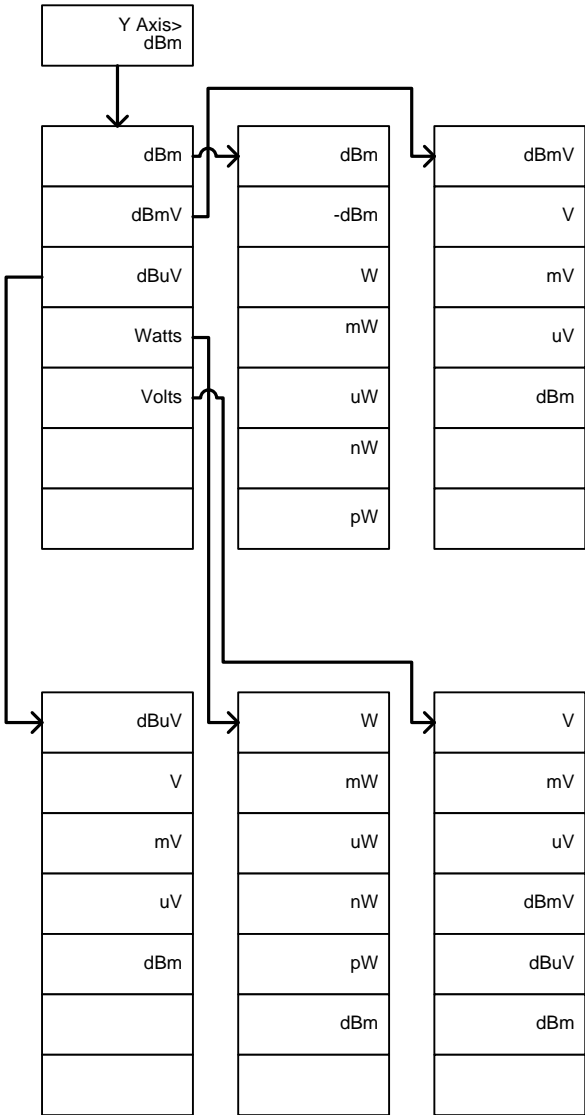

Frequency, Span, Autoset, BW Avg, Sweep

Frequency	Span	Autoset
Center Freq 1.2345GHz	Span 1.2345GHz	Autoset
Start Freq 1.2345GHz	Full Span	Amp. Floor -80.00dBm <u>Auto</u> Man
Stop Freq 1.2345GHz	Zero Span	Span 3.000000MHz <u>Auto</u> Man
CF Step 1.00000MHz <u>Auto</u> Man	Last Span	
Freq Offset 0.00Hz		

BW/Avg		Sweep
RBW 1MHz <u>Auto</u> Man	LOG Power	Sweep Time 50.00 ms <u>Auto</u> Man
VBW 1MHz <u>Auto</u> Man	Volt Average	Sweep Single
VBW/RBW 1.00000	Power Average	Sweep Cont
Average 20 On Off		Gated Sweep Mode <u>On</u> Off
Average Type> Log Power		Gate Delay 50.0 ms
EMI Filter On Off		Gate Length 540 ms
		Sweep Control <u>Norm.</u> Fast

Limit Line

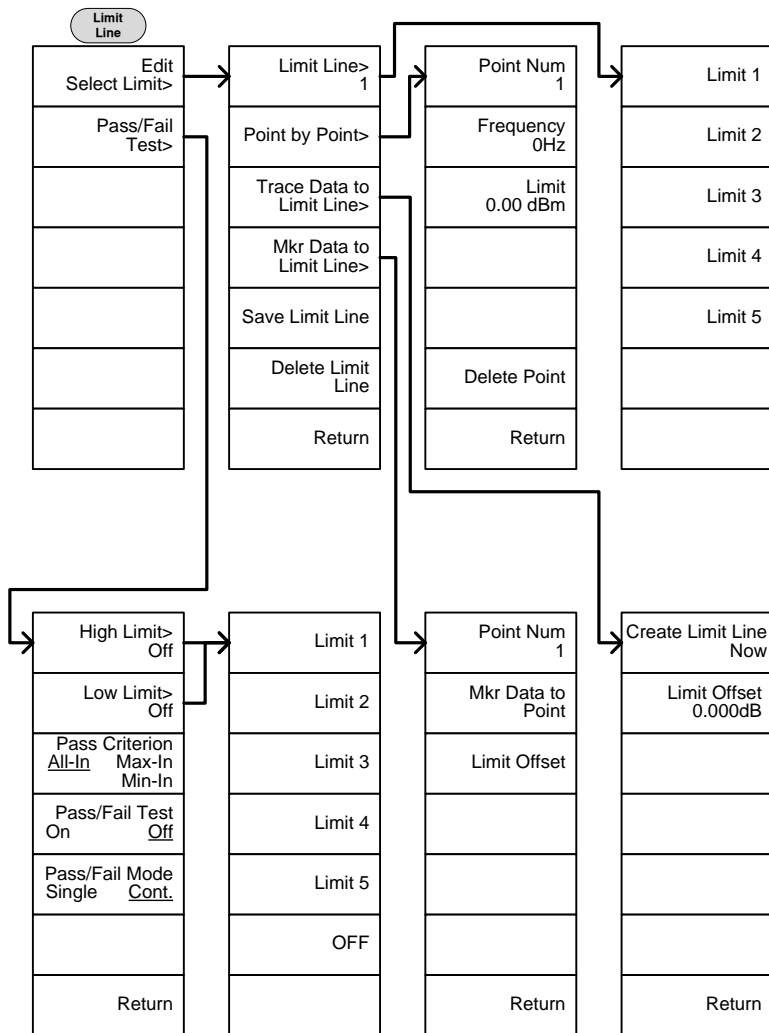

Trigger, Sequence

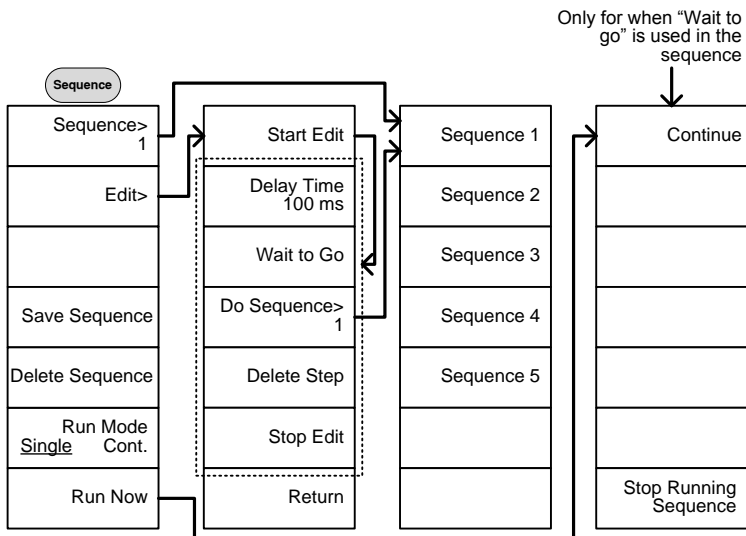
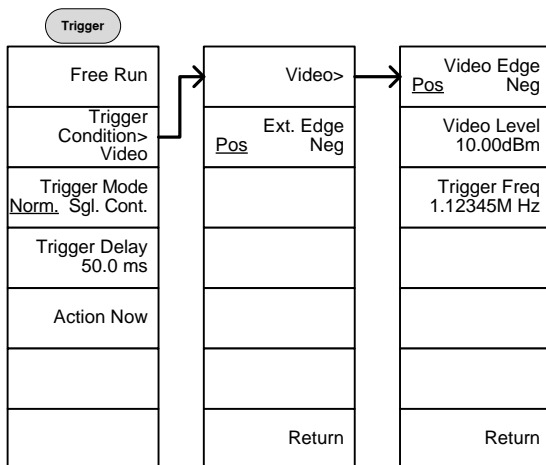

Trace

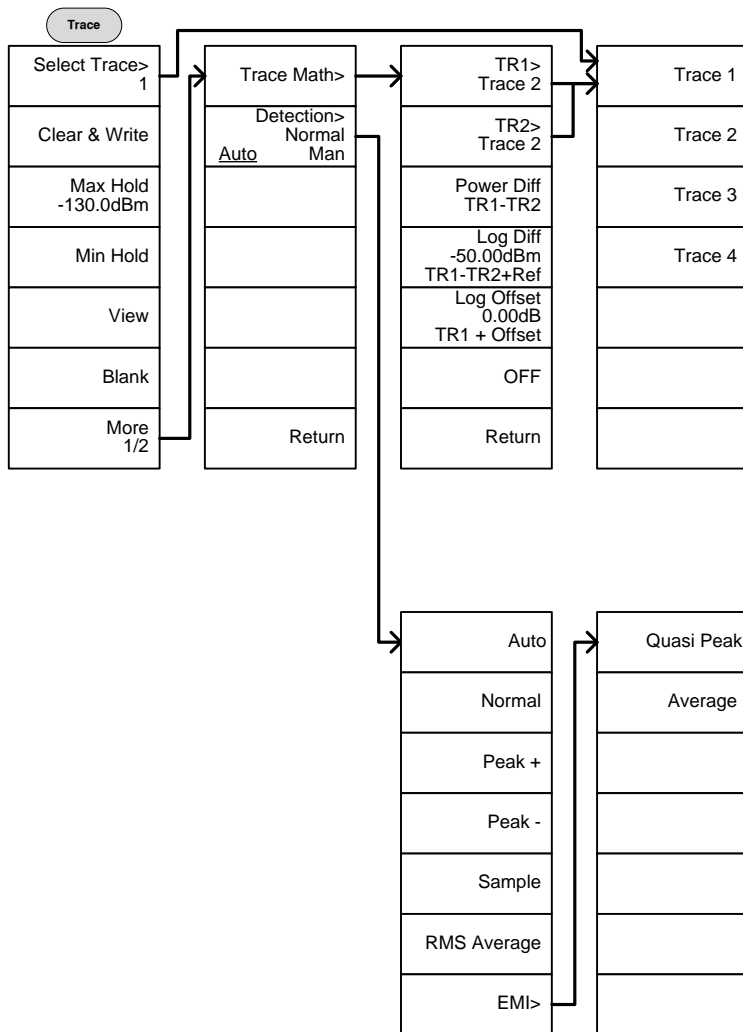

Display

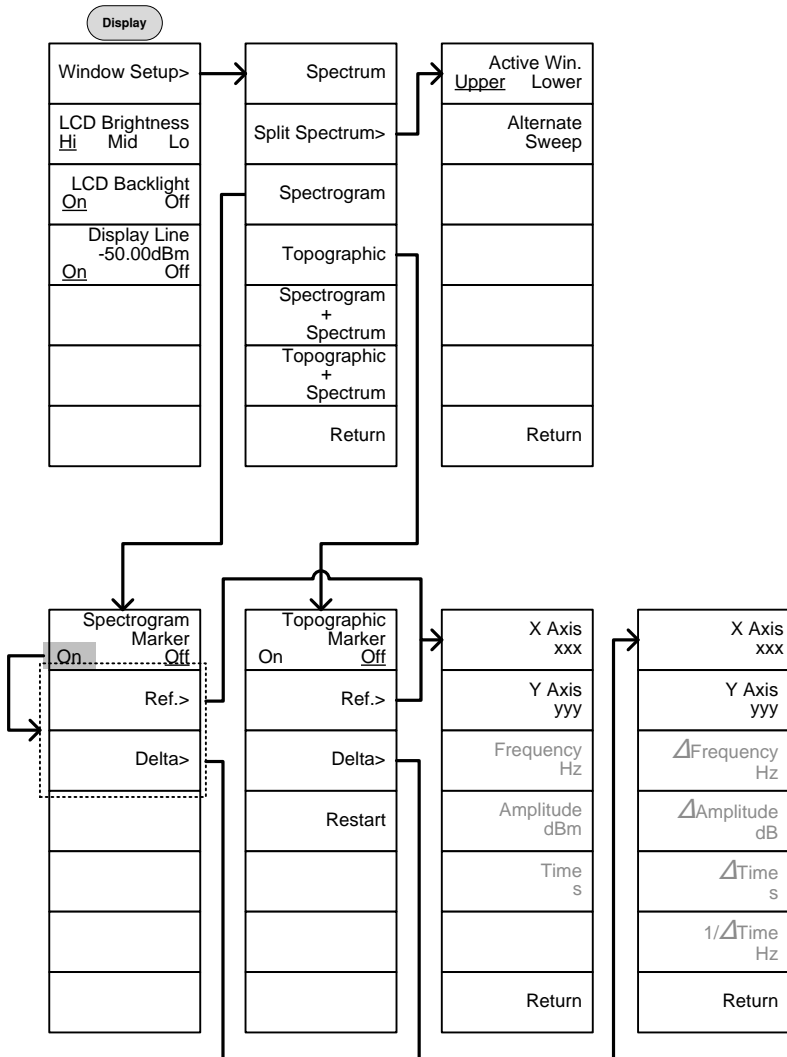

Marker

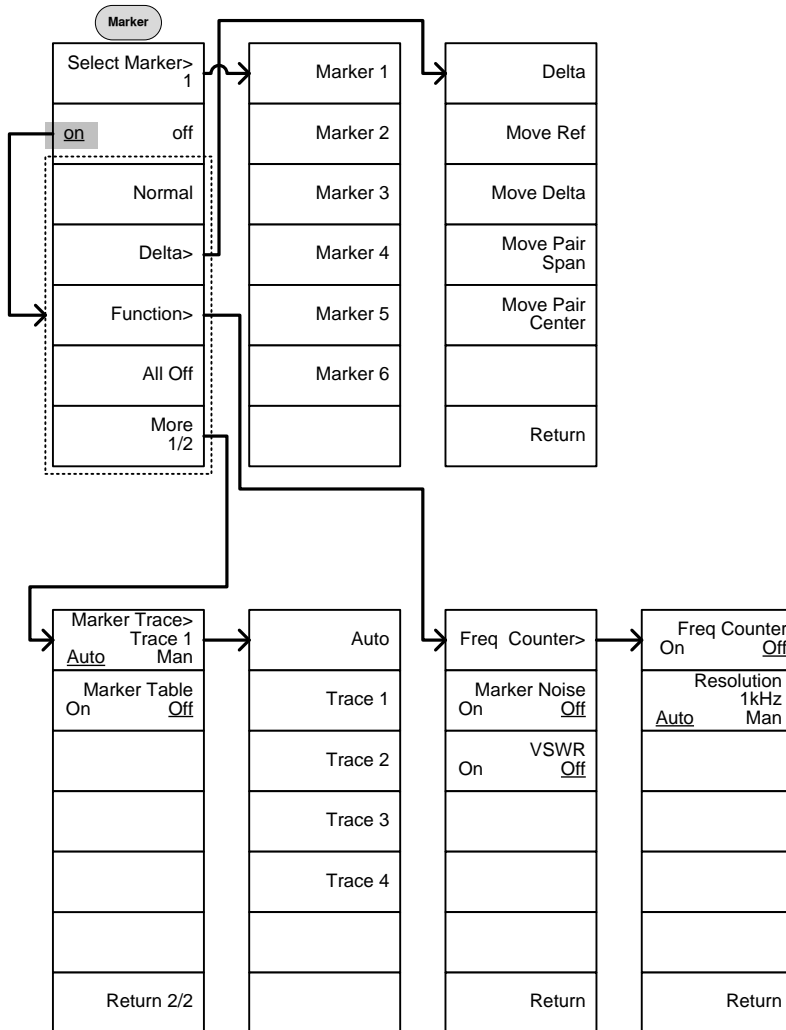

Peak Search, Marker ▶

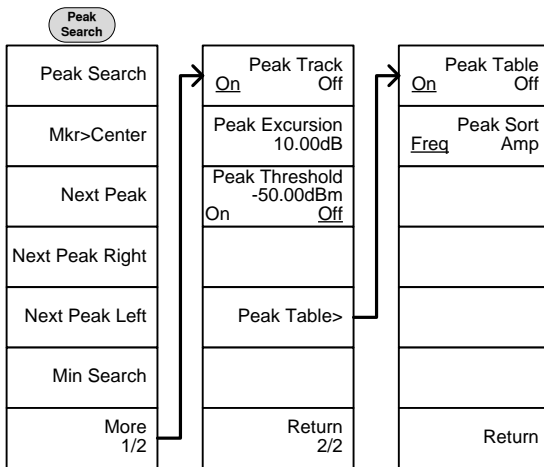

System

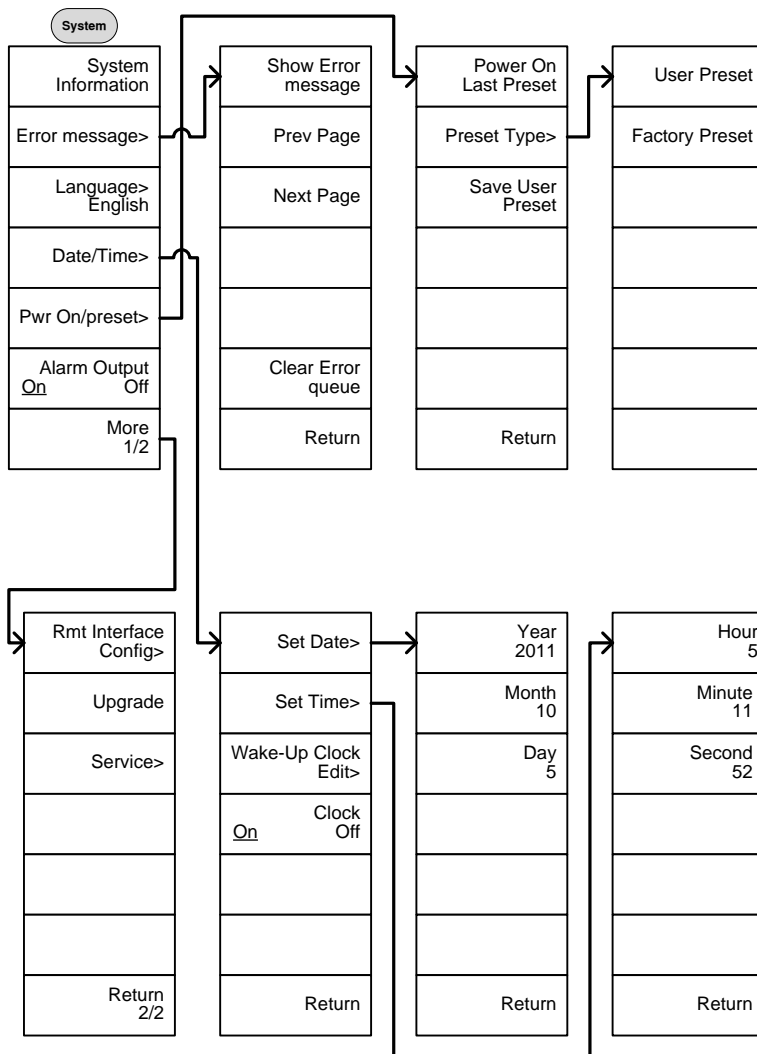

From: System>
Language

↓

English
簡體中文
繁體中文
Русский
日本語
Return

From: System>Date/
Time>Wake-Up Clock Edit>

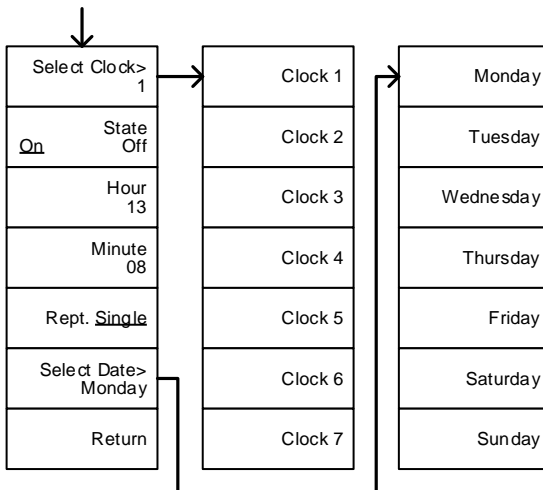

From: System>More 1/2>
Rmt Interface Config>

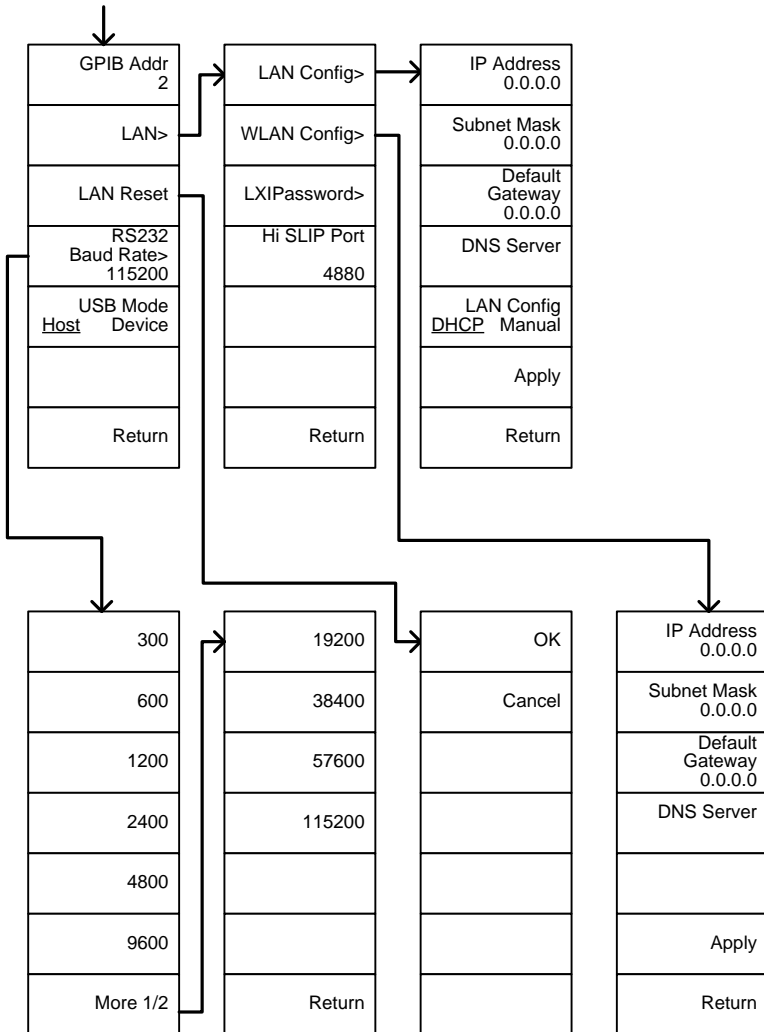

From: System>More 1/2> Rmt
Interface Config>LAN>LXIPassword

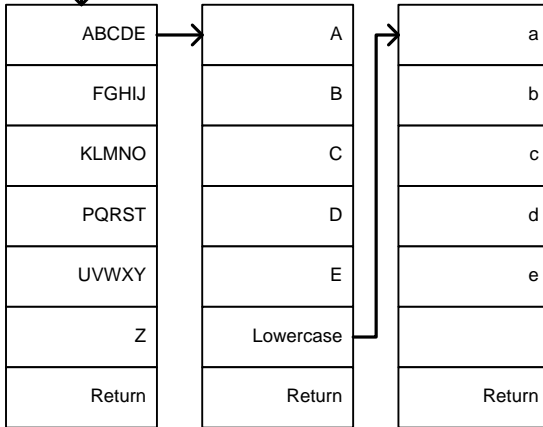

Option Control

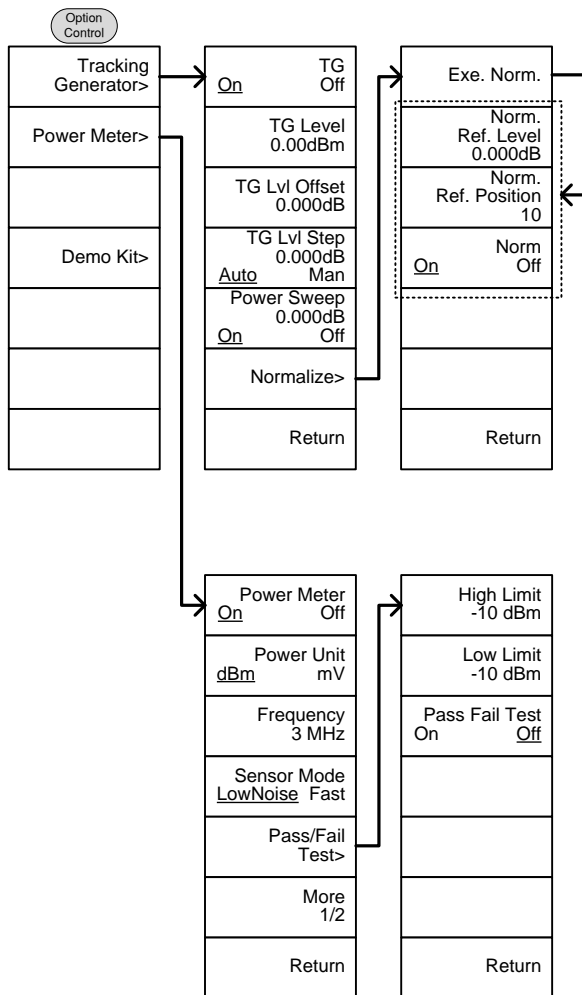

From: Option Control>Demo Kit

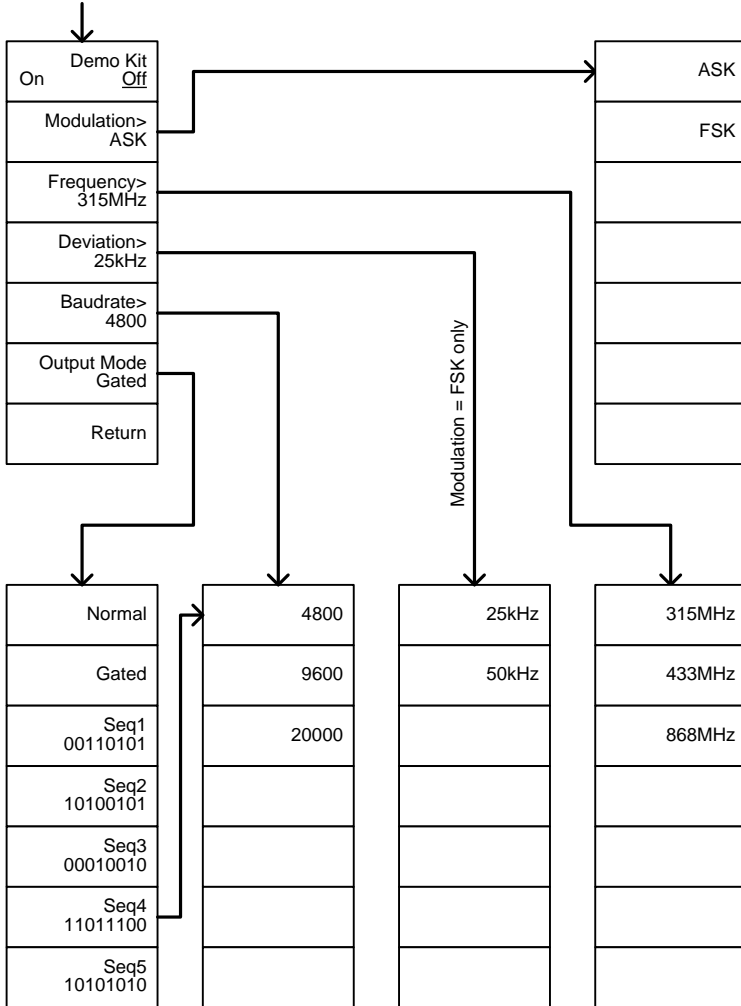

File

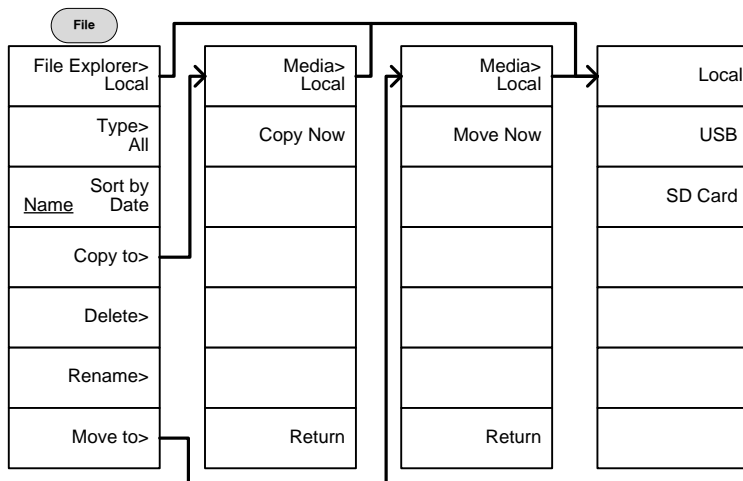

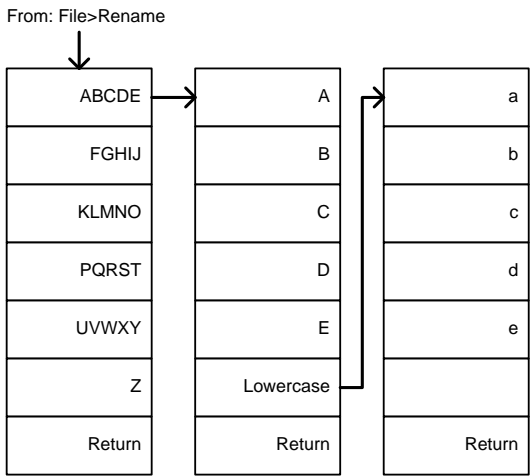
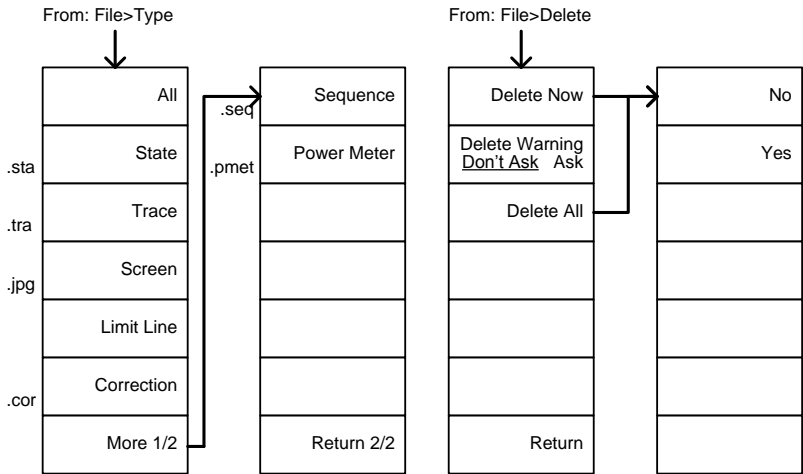

Save

(Mode = Power Meter)

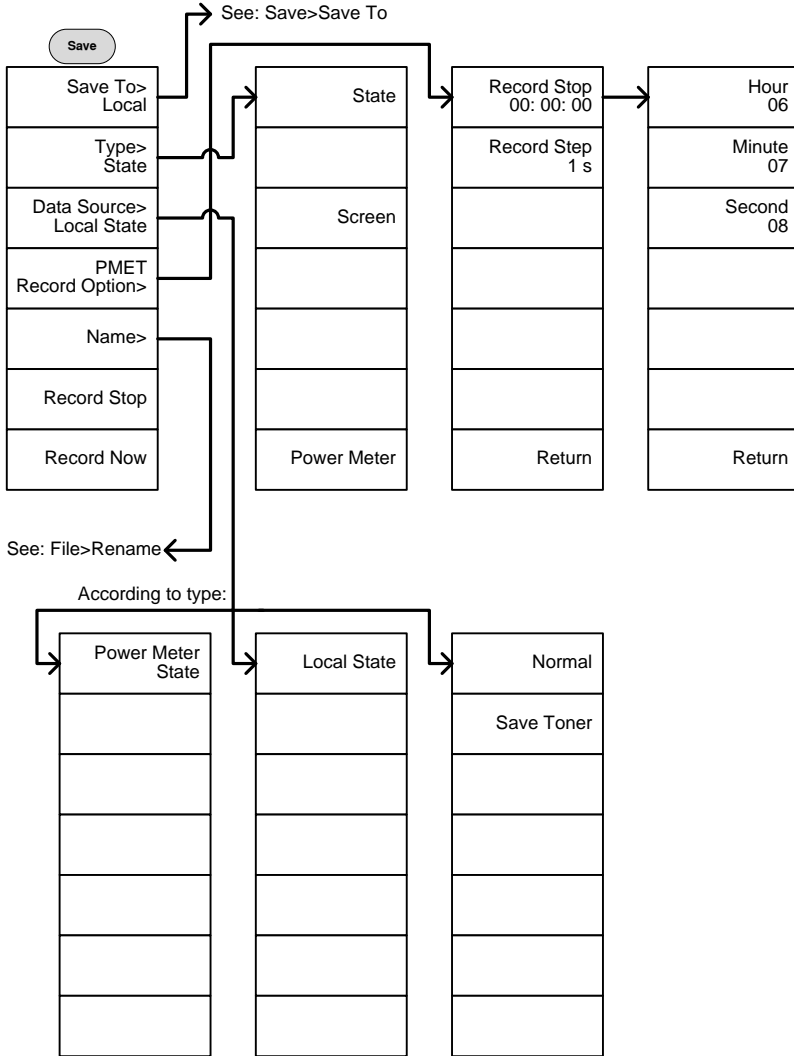

From: Save>Save To

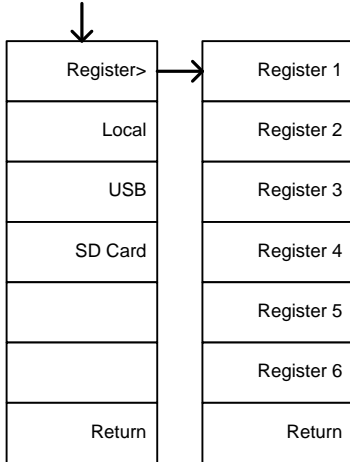

(Mode = Spectrum)

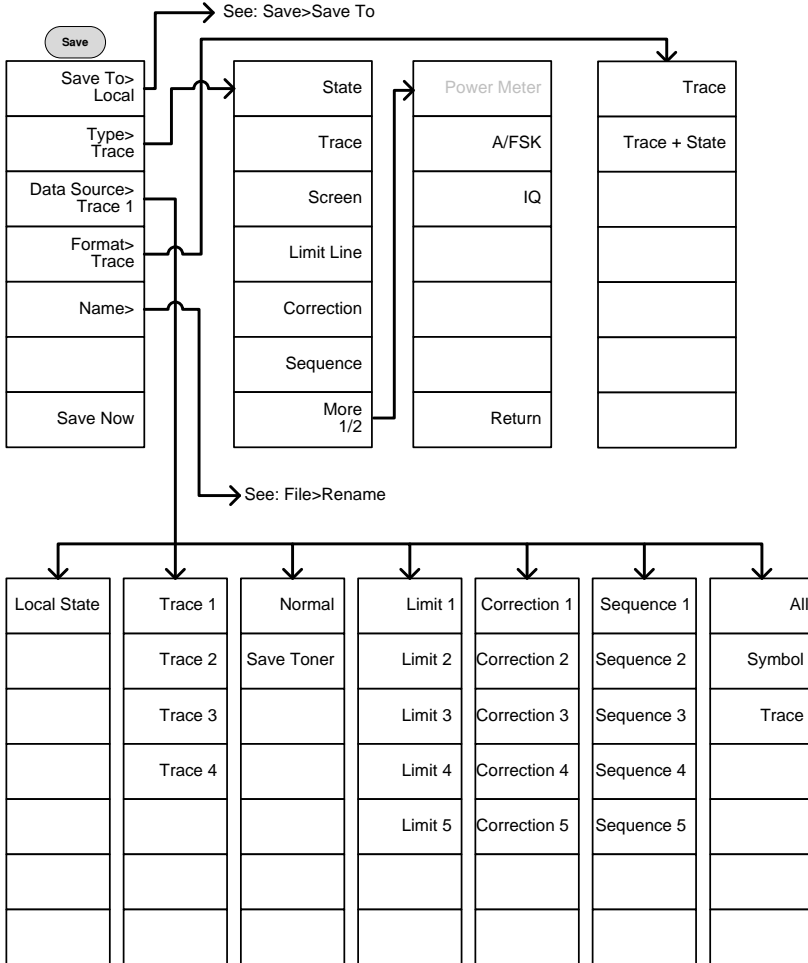

Recall

(Mode = Power Meter)

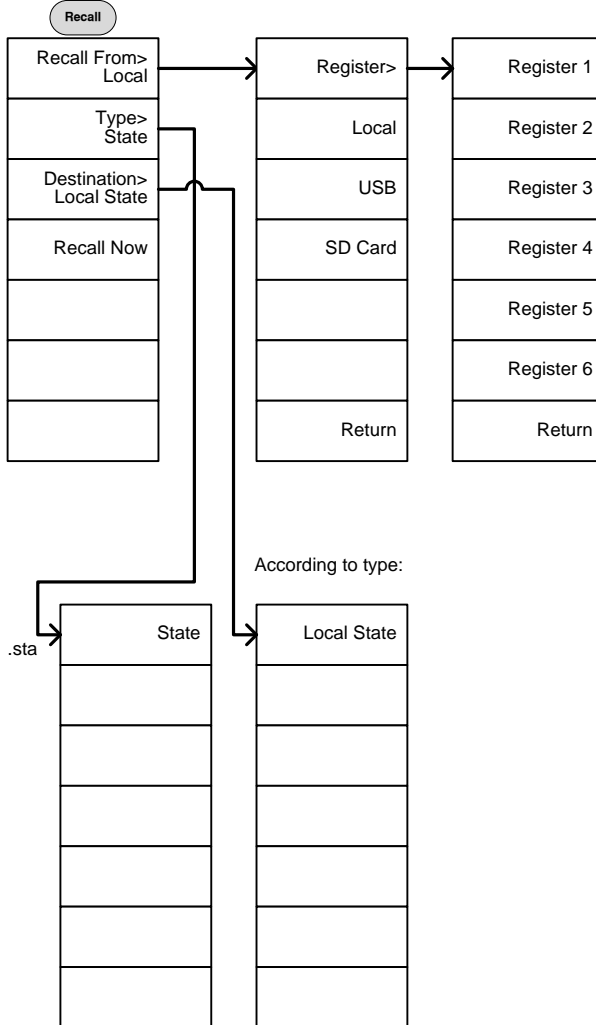

(Mode = Spectrum)

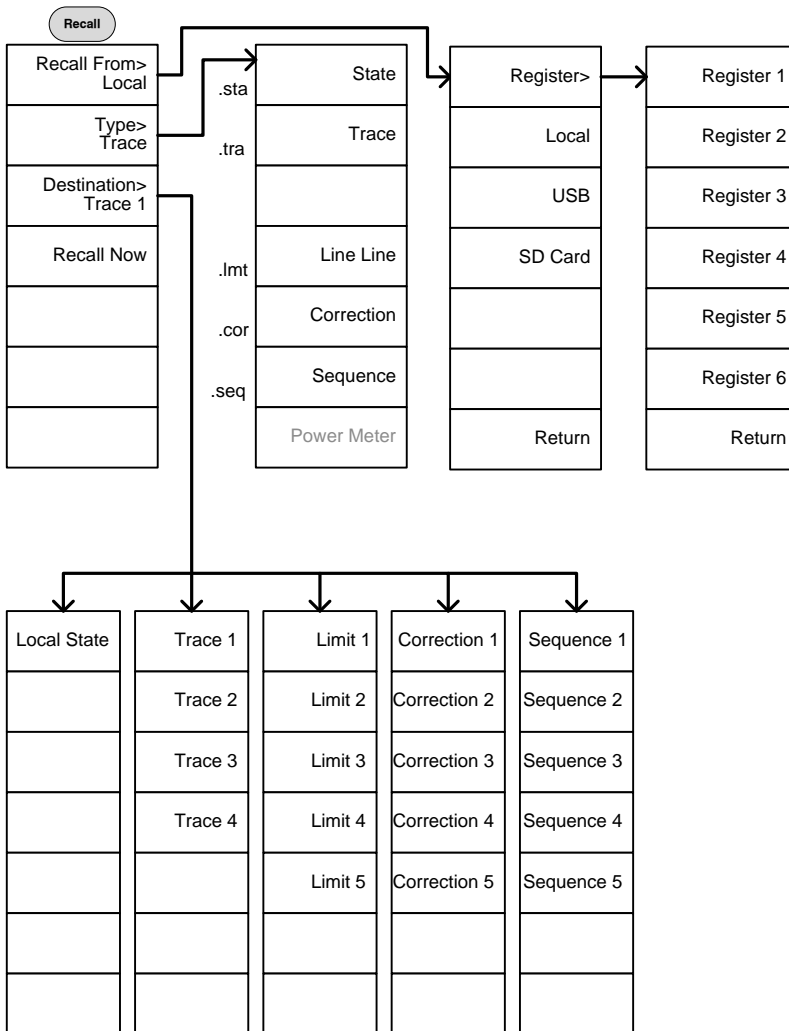

Measure

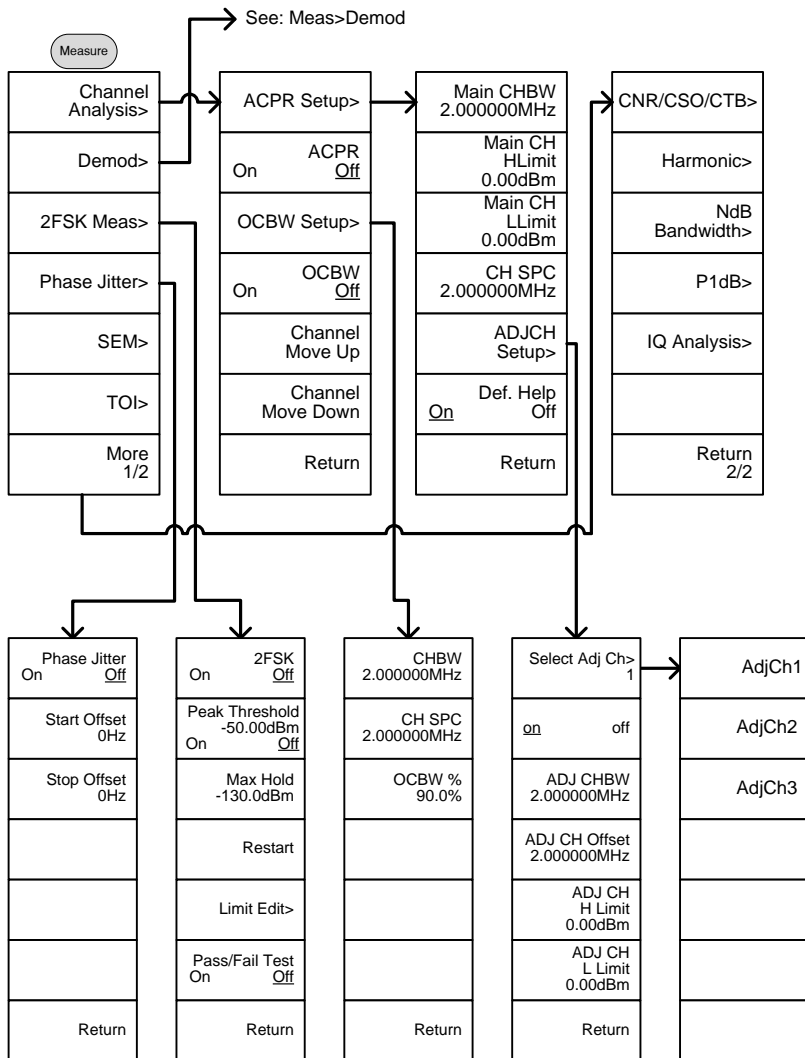

From: Measure>Demod

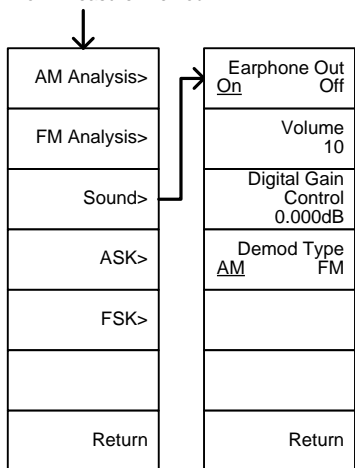

From: Measure>TOI

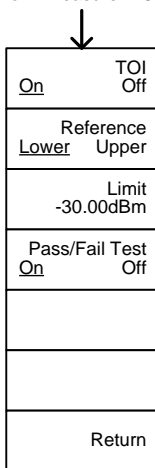

From: Measure>More>NdB Bandwidth

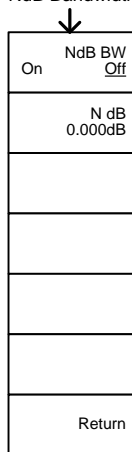

From: Measure>More>CNR/CSO/CTB

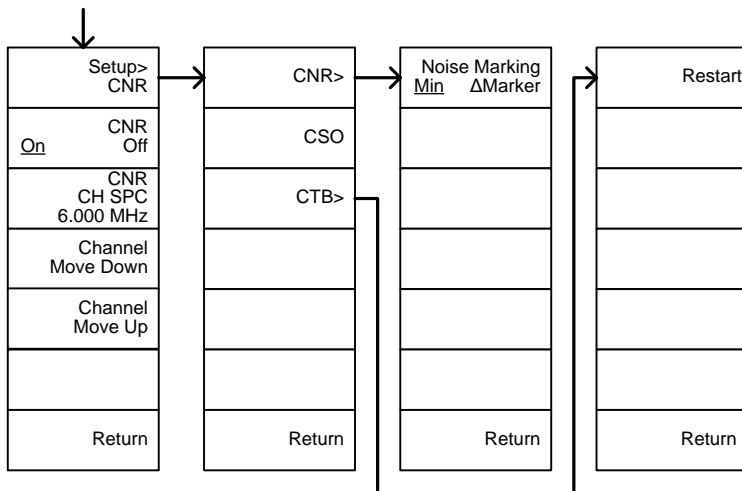

From: Measure>More>IQ Analysis

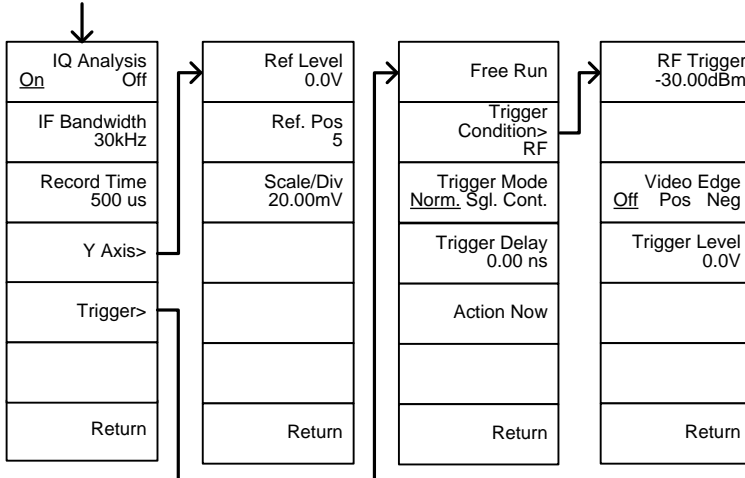

From: Measure>Demod>AM
Analysis

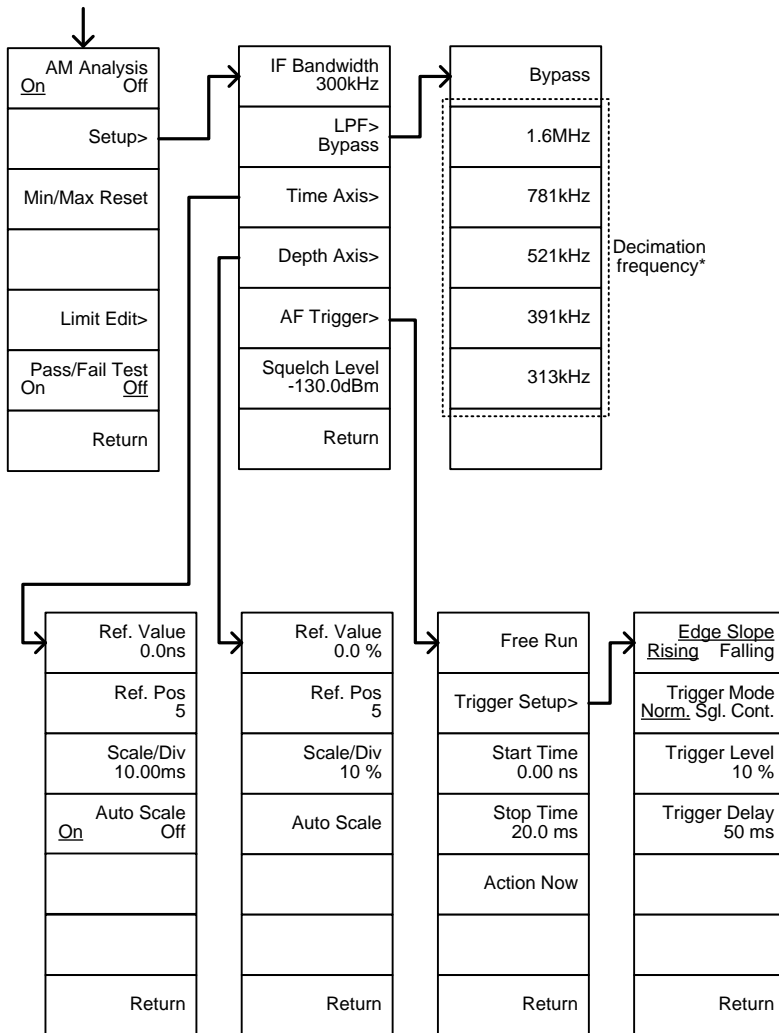

* see page 131 for the selectable LPF filter bandwidths.

From: Measure>Demod>FM
Analysis

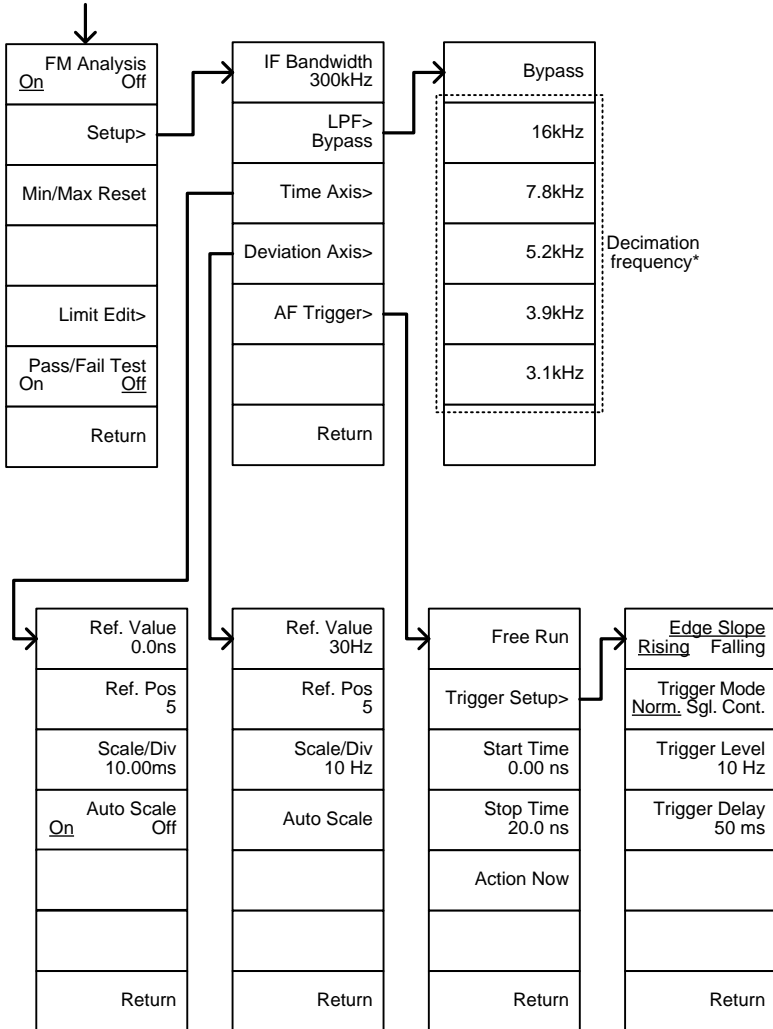

* see page 136 for the selectable LPF filter bandwidths.

From: Measure>Demod>ASK

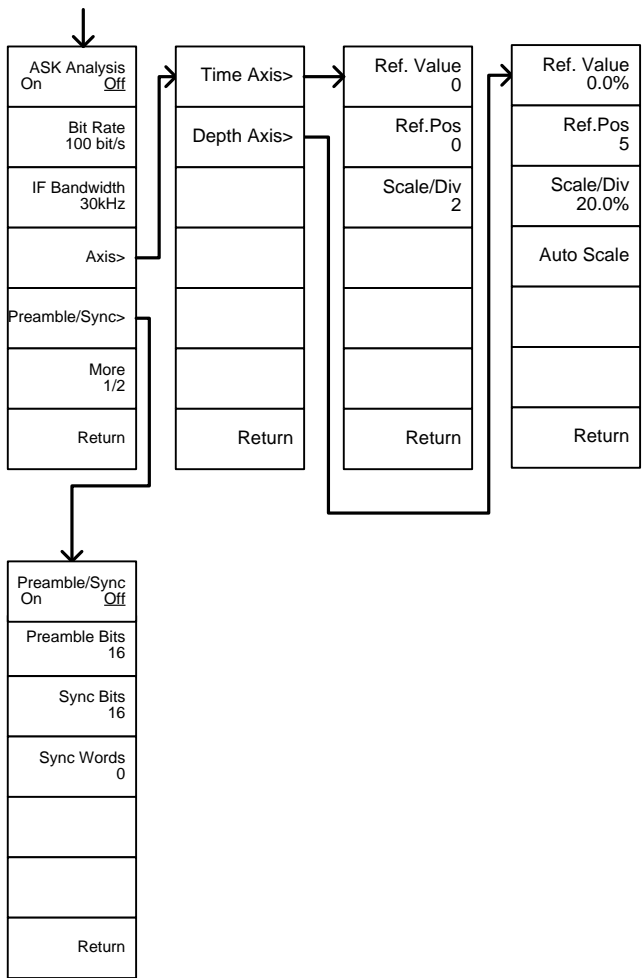

From: Measure>Demod>ASK>More 1/2

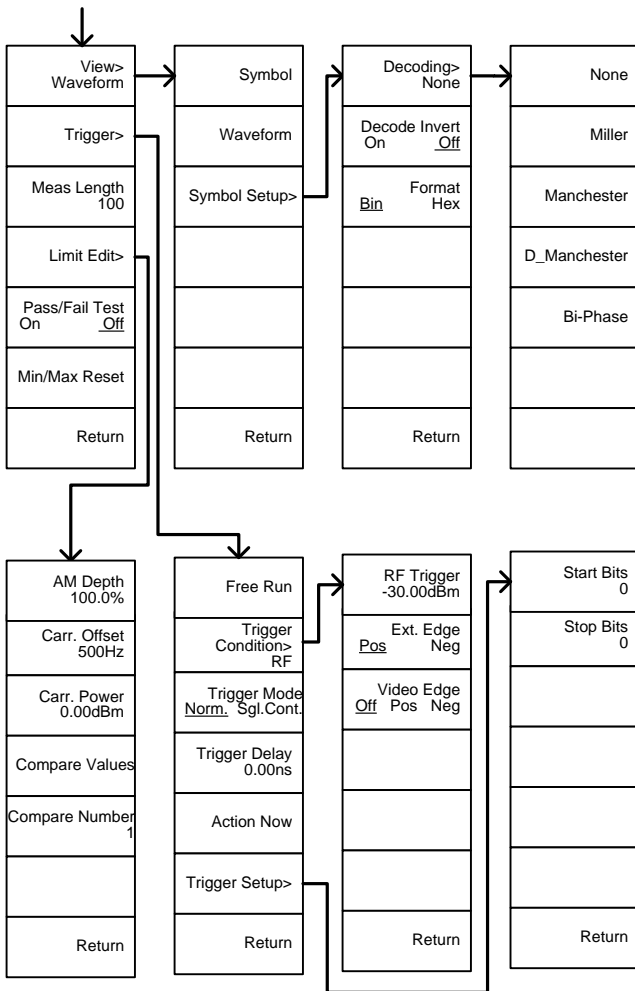

From: Measure>Demod>FSK

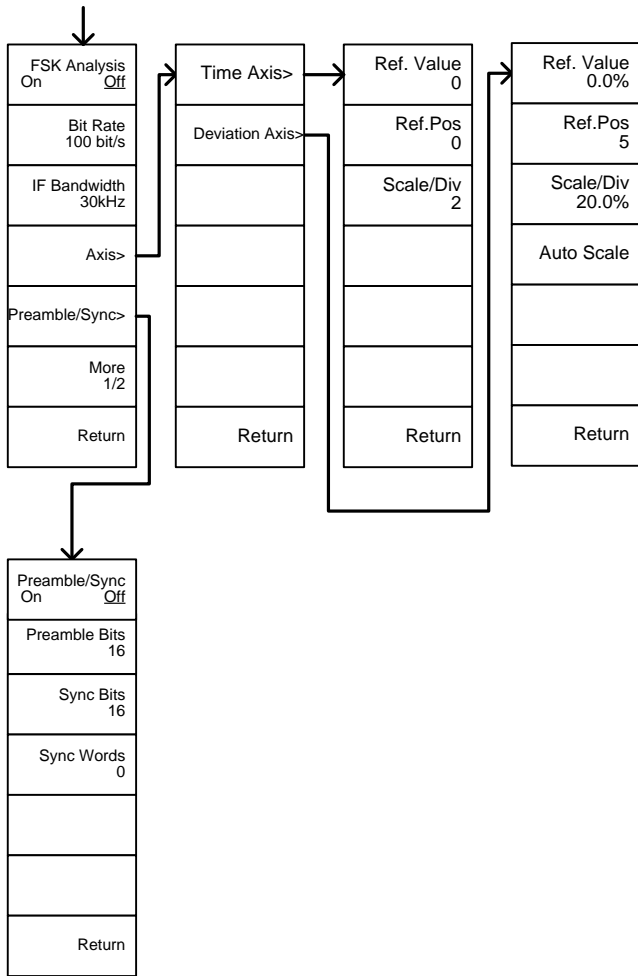

From: Measure>Demod>FSK>More 1/2

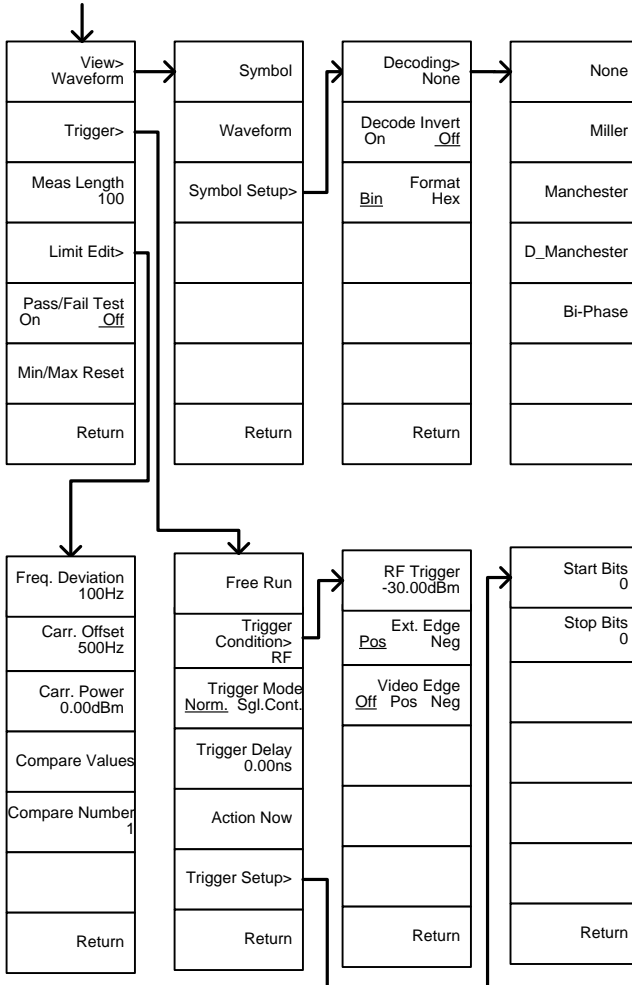

From: Measure>2FSK>Limit Edit

↓

Freq. Deviation 200.000kHz
Carr.Offset 200.000kHz
High Limit 30.00dBm
Low Limit -120.0 dBm
Return

From: Measure>Demod>AM Analysis>Limit Edit

↓

AM Depth 100.0%
Carr.Offset 200.000kHz
Carr.Power 0.00dBm
Return

From: Measure>Demod>FM Analysis>Limit Edit

↓

Freq. Deviation 200.000kHz
Carr.Offset 200.000kHz
Carr.Power 0.00dBm
Return

From: Measure>SEM

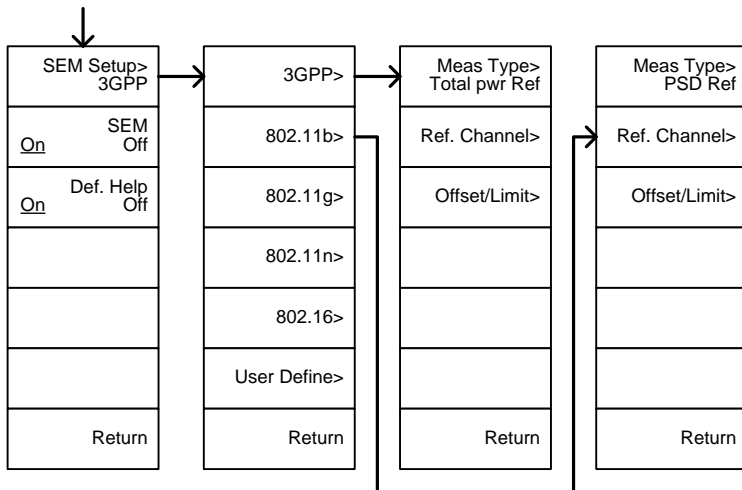

From: Measure>SEM>3GPP>
REF. Channel

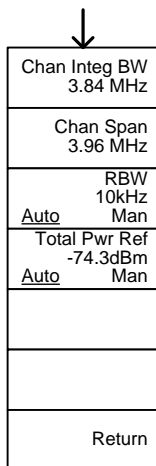

From: Measure>SEM>3GPP>
Offset/Limit

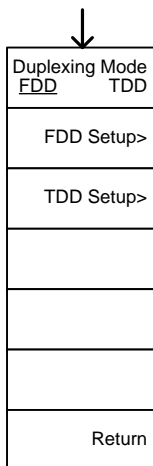

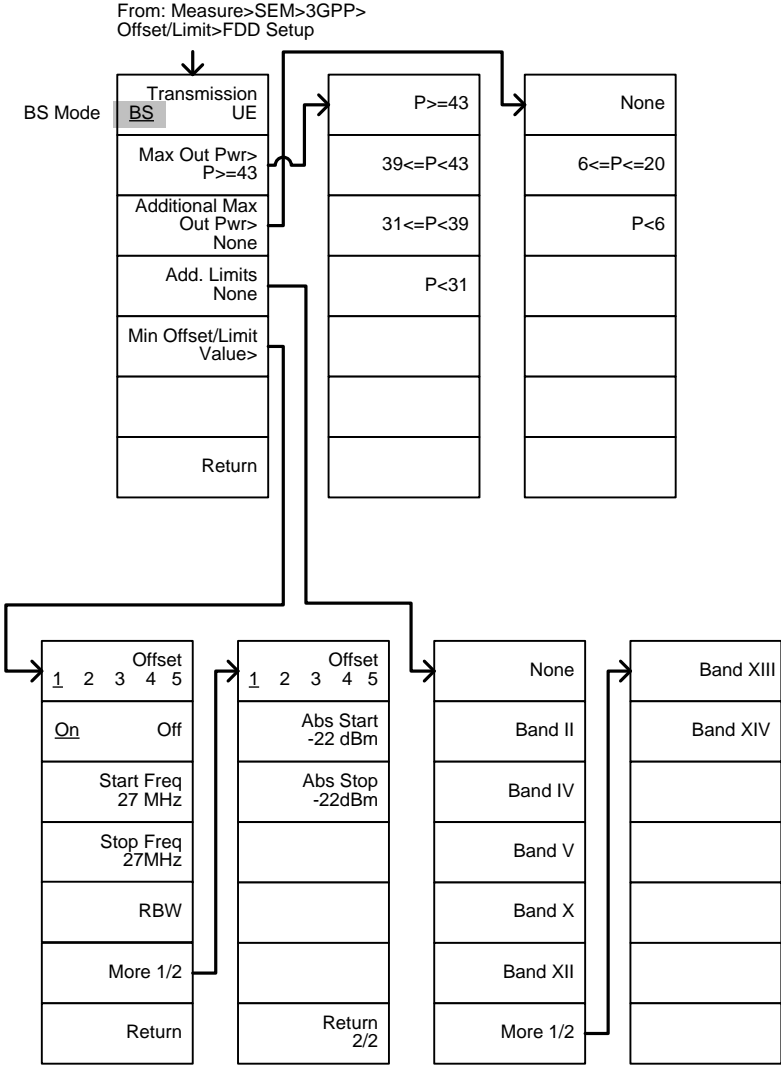

From: Measure>SEM>3GPP>
Offset/Limit>FDD Setup

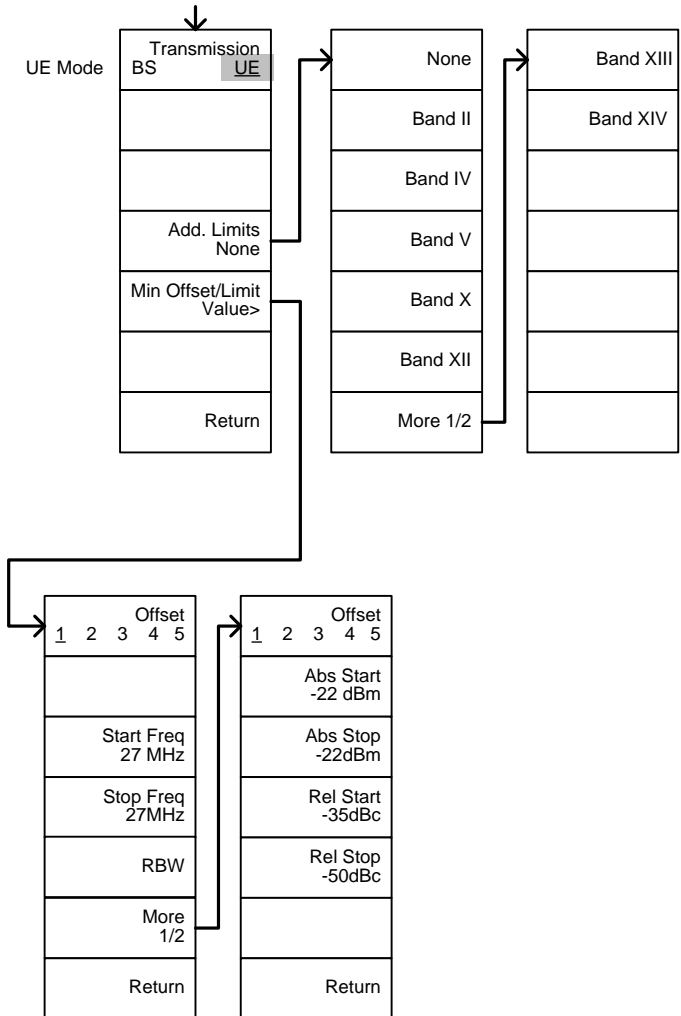

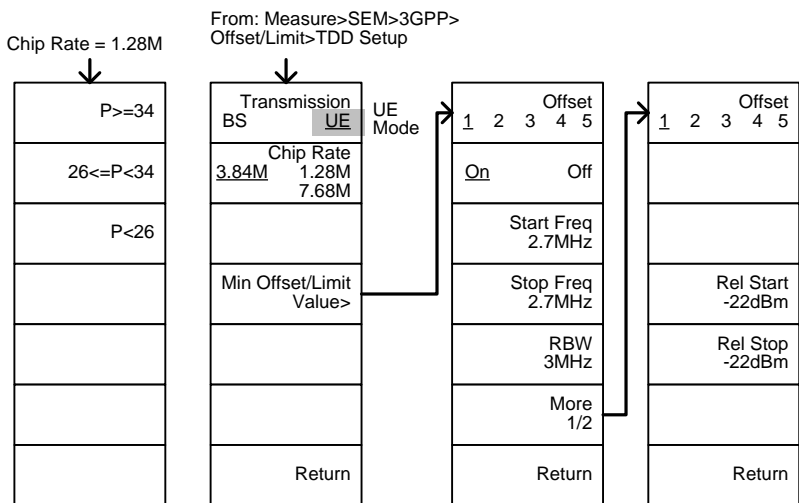
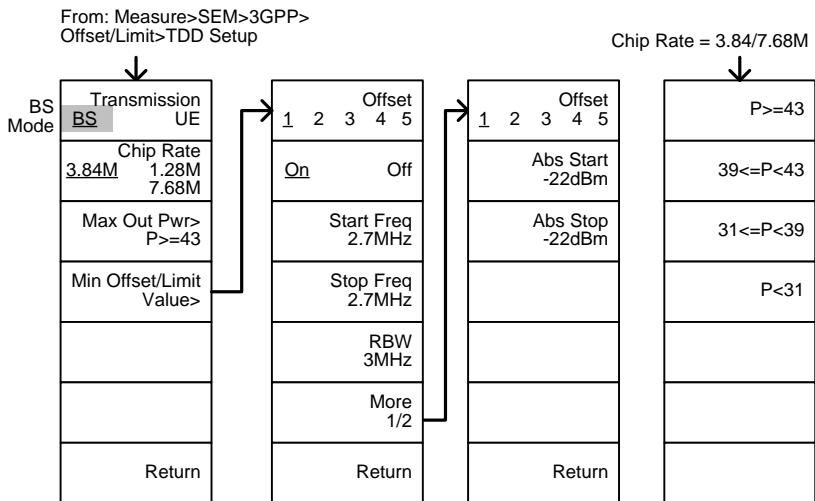

From: Measure>SEM>
User Define>

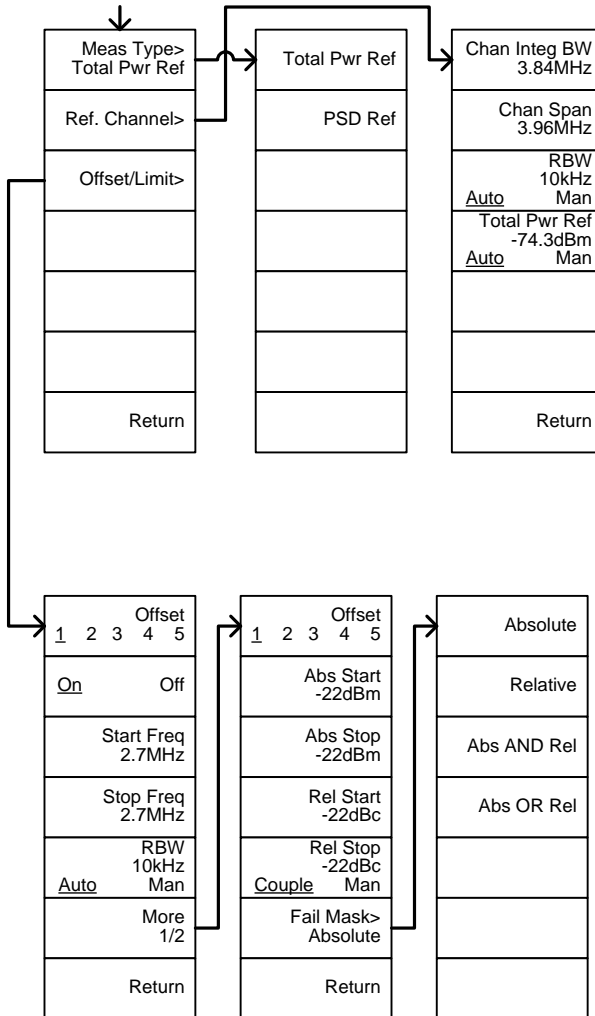

From: Measure>TOI

↓	
<u>On</u>	TOI Off
Reference	
<u>Lower</u>	Upper
Limit 0.00dBm	
Pass/Fail Test On Off	
Return	

From: Measure>More
>Harmonic

↓	
<u>On</u>	Harmonic Off
Fundamental Freq. 1.000000MHz	
Number of Order 5	
RBW 10kHz	
<u>Auto</u>	Man
Return	

From: Measure>
More>NdB Bandwidth

↓	
<u>On</u>	NdB BW Off
NdB 3.000dB	
Return	

From: Measure>More>P1dB

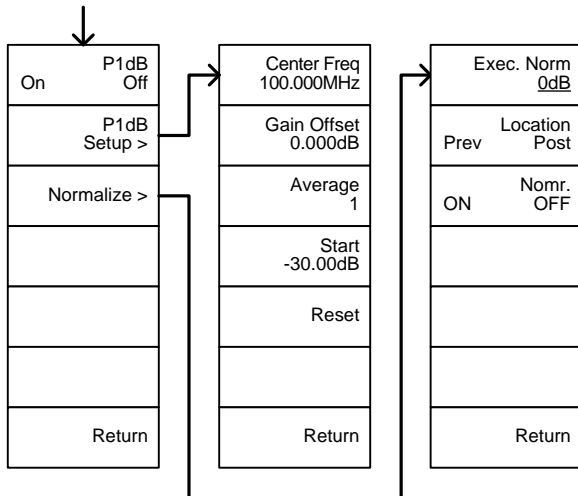

EMC Pretest

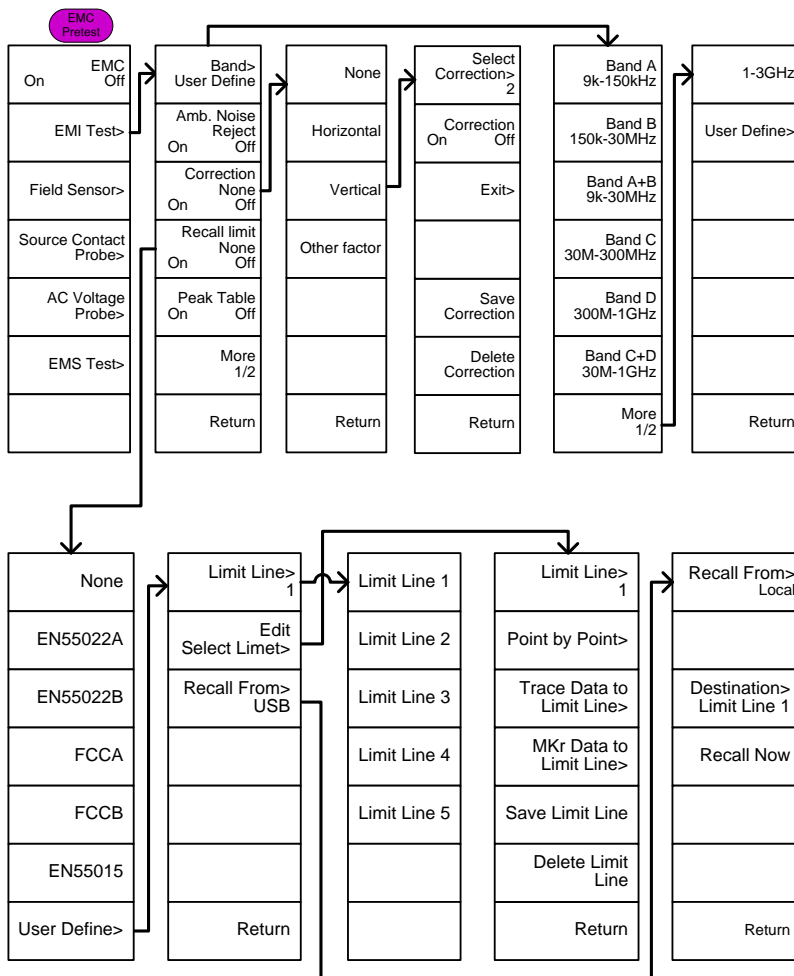

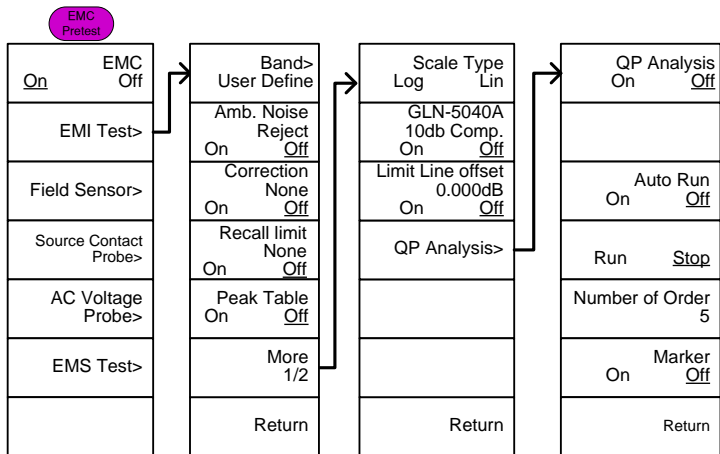

EMI test:
Band = 9k-150kHz or 150k-30MHz

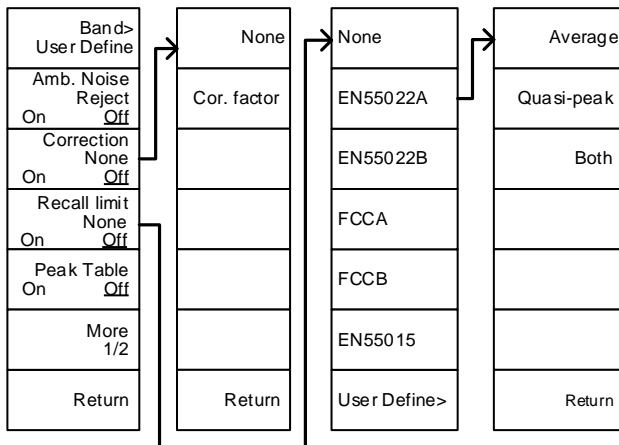

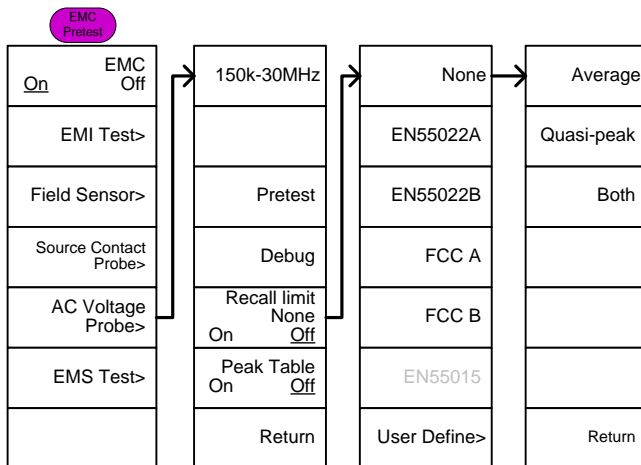
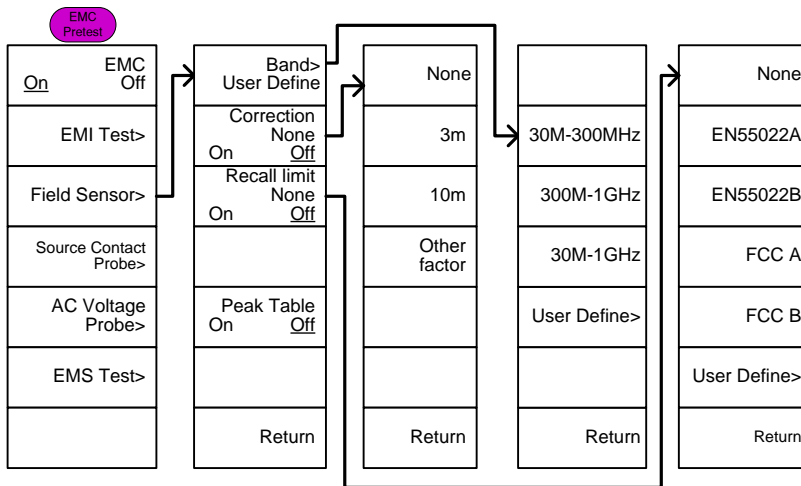

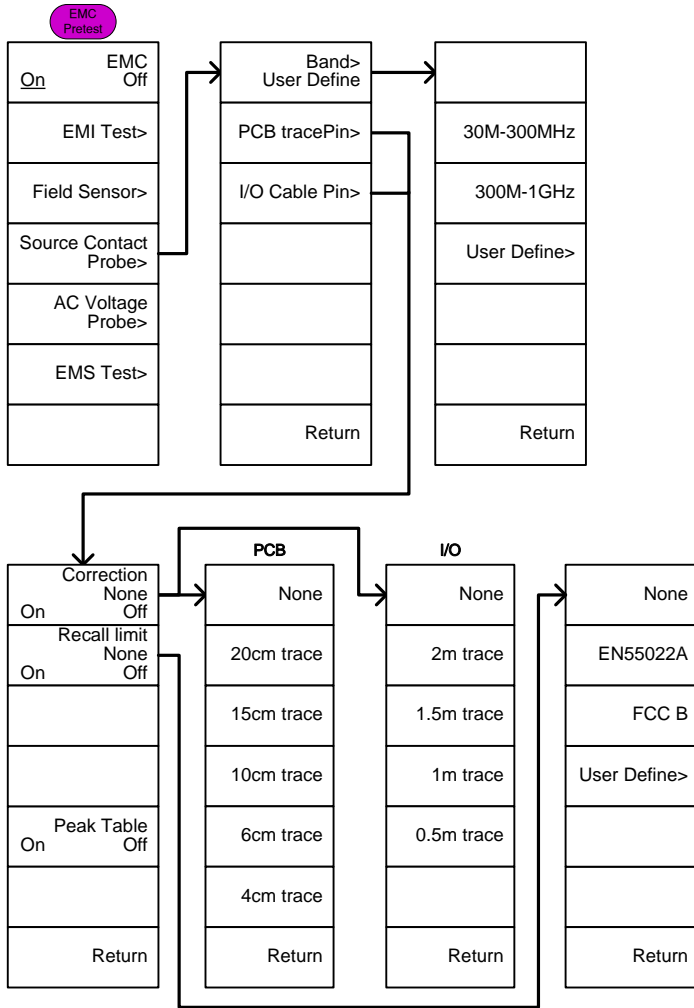

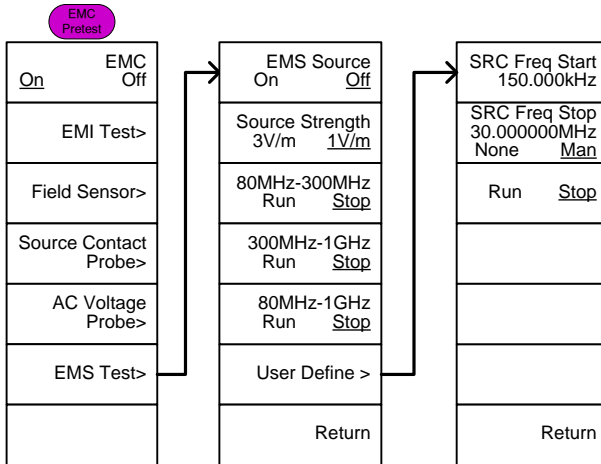

GSP-9330 Specifications

The specifications apply when the GSP is powered on for 45 minutes* to warm-up to a temperature of 20°C to 30°C, unless specified otherwise.

* 45 minutes typical, 90 minutes maximum.

Frequency

Frequency		
Range	9 kHz to 3.25 GHz	
Resolution	1 Hz	
Frequency Reference		
Accuracy	±(period since last adjustment X aging rate) + stability over temperature + supply voltage stability	
Aging Rate	±1 ppm max.	1 year after last adjustment
Frequency Stability over Temperature	±0.025 ppm	0 to 50 °C
Supply Voltage Stability	±0.02 ppm	
Frequency Readout Accuracy		
Start, Stop, Center, Marker	±(marker frequency indication X frequency reference accuracy + 10% x RBW + frequency resolution ¹)	
Trace points	Max 601 points, min 6 points	
Marker Frequency Counter		
Resolution	1 Hz, 10 Hz, 100 Hz, 1 kHz	
Accuracy	±(marker frequency indication X frequency reference accuracy + counter resolution)	RBW/Span ≥0.02 ; Mkr level to DNL>30 dB
Frequency Span		
Range	0 Hz (zero span), 100 Hz to 3.25 GHz	
Resolution	1 Hz	
Accuracy	± frequency resolution ¹	RBW: Auto;

Phase Noise

Offset from Carrier		Fc = 1 GHz; RBW = 1 kHz, VBW = 10 Hz; Average ≥ 40
10 kHz	<-88 dBc/Hz	<i>Typical²</i>
100 kHz	<-95 dBc/Hz	<i>Typical</i>
1 MHz	<-113 dBc/Hz	<i>Typical</i>

Resolution Bandwidth (RBW) Filter

Filter Bandwidth	1 Hz to 1 MHz in 1-3-10	-3dB bandwidth sequence
	200 Hz, 9 kHz, 120 kHz, 1MHz	-6dB bandwidth
Accuracy	± 8%, RBW = 1MHz	Nominal ³
	± 5%, RBW < 1MHz	Nominal
Shape Factor	< 4.5:1	Nominal ; Normal Bandwidth ratio: -60dB:-3dB

Video Bandwidth (VBW) Filter

Filter Bandwidth	1 Hz to 1 MHz in 1-3-10	-3dB bandwidth sequence
------------------	-------------------------	-------------------------

[1] Frequency Resolution = Span/(Trace points - 1)

[2] Typical specifications in this datasheet mean that the performance can be exhibited in 80% of the units with a 95% confidence level over the temperature range 20 to 30 °C. They are not covered by the product warranty.

[3] Nominal values indicate expected performance. They are not covered by the product warranty.

Amplitude

Amplitude Range

Measurement Range	100 kHz to 1 MHz	Displayed Average Noise Level (DANL) to 18 dBm
	1 MHz to 10 MHz	DANL to 21 dBm
	10 MHz to 3.25 GHz	DANL to 30 dBm

Attenuator

Input Attenuator Range	0 to 50 dB, in 1 dB step	Auto or manual setup
------------------------	--------------------------	----------------------

Maximum Safe Input Level

Average Total Power	≤ +33 dBm	Input attenuator ≥ 10 dB
DC Voltage	± 50 V	

1 dB Gain Compression		
Total Power at 1st Mixer	> 0 dBm	<i>Typical</i> ; Fc ≥ 50 MHz; preamp. off
Total Power at the Preamp	> -22 dBm	<i>Typical</i> ; Fc ≥ 50 MHz; preamp. on

mixer power level (dBm) = input power (dBm) - attenuation (dB)

Displayed Average Noise Level (DANL) ⁴		
Preamp off	0 dB attenuation; RF Input is terminated with a 50Ω load. RBW 10 Hz; VBW 10 Hz; span 500 Hz; reference level = -60dBm; trace average ≥ 40	
9 kHz to 100 kHz	< -93 dBm	
100 kHz to 1 MHz	< -90 dBm - 3 x (f/100 kHz) dB	
1 MHz to 2.7 GHz	< -122 dBm	Nominal
2.7 GHz to 3.25 GHz	< -116 dBm	
Preamp on	0 dB attenuation; RF Input is terminated with a 50Ω load ; RBW 10 Hz; VBW 10Hz; span 500 Hz; reference level = -60dBm; trace average ≥ 40	
100 kHz to 1 MHz	< -108 dBm - 3 x (f/100 kHz) dB	
1 MHz to 10 MHz	< -142 dBm	Nominal
10 MHz to 3.25 GHz	< -142 dBm + 3 x (f/1 GHz) dB	

[4] DANL spec excludes spurious response.

Level Display Range		
Scales	Log, Linear	
Units	dBm, dBmV, dBuV, V, W	
Marker Level	0.01 dB	Log scale
Readout	0.01 % of reference level	Linear scale
Level Display Modes	Trace, Topographic, Spectrogram	Single / split Windows
Number of Traces	4	
Detector	Positive-peak, negative-peak, sample, normal, RMS(not Video), Quasi-Peak, Average	Can be setup for each trace separately
Trace Functions	Clear & Write, Max/Min Hold, View, Blank, Average	

Absolute Amplitude Accuracy

Absolute Point	Center=160 MHz ; RBW 10 kHz; VBW 1 kHz; span 100 kHz; log scale; 1 dB/div; peak detector; 23°C±1°C; Signal at Reference Level	
Preamp off	± 0.3 dB	Ref level 0 dBm; 10 dB RF attenuation
Preamp on	± 0.4 dB	Ref level -30 dBm; 0 dB RF attenuation

Frequency Response

Preamp off	Attenuation: 10 dB; Reference: 160 MHz; 20 to 30°C	
100 kHz to 2.0 GHz	± 0.5 dB	
2GHz to 3.25 GHz	± 0.7 dB	
Preamp on	Attenuation: 0 dB; Reference: 160 MHz; 20 to 30°C	
1 MHz to 2 GHz	± 0.6 dB	
2 GHz to 3.25 GHz	± 0.8 dB	

Attenuation Switching Uncertainty

Attenuator setting	0 to 50 dB in 1 dB step	
Uncertainty	± 0.25 dB	reference: 160 MHz, 10dB attenuation

RBW Filter Switching Uncertainty

1 Hz to 1 MHz	± 0.25 dB	reference : 10 kHz RBW
---------------	-----------	------------------------

Level Measurement Uncertainty

Overall Amplitude Accuracy	± 1.5 dB	20 to 30°C; frequency > 1 MHz; Signal input 0 to -50 dBm; Reference level 0 to -50 dBm; Input attenuation 10 dB; RBW 1 kHz; VBW 1 kHz; after cal; Preamp Off
	± 0.5 dB	<i>Typical</i>

Spurious Response		
Second Harmonic Intercept		Preamp off; signal input -30dBm; 0 dB attenuation
	+35 dBm	<i>Typical</i> ; 10 MHz < fc < 775 MHz
	+60 dBm	<i>Typical</i> ; 775 MHz ≤ fc < 1.625 GHz
Third-order Intercept		Preamp off; signal input -30dBm; 0 dB attenuation
	> 1dBm	300 MHz to 3.25 GHz
Input Related Spurious	< -60 dBc	Input signal level -30 dBm, Att. Mode, Att=0dB; 20-30°C
Residual Response (inherent)	<-90 dBm	Input terminated; 0 dB attenuation; Preamp off

Sweep

Sweep Time		
Range	204 us to 1000 s	Span > 0 Hz
	50 us to 1000 s	Span = 0 Hz; Min Resolution = 10 us
Sweep Mode	Continuous; Single	
Trigger Source	Free run; Video; External	
Trigger Slope	Positive or negative edge	

RF Preamplifier

Frequency Range	1 MHz to 3.25 GHz	
Gain	18 dB	Nominal (installed as standard)

Front Panel Input/Output

RF Input		
Connector Type	N-type female	
Impedance	50 ohm	Nominal
VSWR	<1.6 :1	300 kHz to 3.25 GHz; Input attenuator ≥ 10 dB

Power for Option

Connector Type	SMB male	
Voltage/Current	DC +7V / 500 mA max	With short-circuit protection

USB Host

Connector Type	A plug	
Protocol	Version 2.0	Supports Full/High/Low speed

MicroSD Socket

Protocol	SD 1.1	
Supported Cards	microSD, microSDHC	Up to 32GB capacity

Rear Panel Input/Output

Reference Output

Connector Type	BNC female	
Output Frequency	10 MHz	Nominal
Output Amplitude	3.3V CMOS	
Output Impedance	50 ohm	

Reference Input

Connector Type	BNC female	
Input Reference Frequency	10 MHz	
Input Amplitude	-5 dBm to +10 dBm	
Frequency Lock Range	Within ± 5 ppm of the input reference frequency	

Alarm Output

Connector Type	BNC female	Open-collector
----------------	------------	----------------

Trigger Input/ Gated Sweep Input

Connector Type	BNC female	
Input Amplitude	3.3V CMOS	
Switch	Auto selection by function	

LAN TCP/IP Interface

Connector Type	RJ-45	
Base	10Base-T; 100Base-Tx; Auto-MDIX	

USB Device

Connector Type	B plug	For remote control only; supports USB TMC
Protocol	Version 2.0	Supports Full/High/Low speed

IF Output			
Connector Type	SMA female		
Impedance	50 ohm	Nominal	
IF Frequency	886 MHz	Nominal	
Output level	-25 dBm	10 dB attenuation; RF input: 0 dBm @ 1 GHz	
Earphone Output			
Connector Type	3.5mm stereo jack, wired for mono operation		
Video Output			
Connector Type	DVI-I (integrated analog and digital) , Single Link. Compatible with VGA or HDMI standard through adapter		
RS232 Interface			
Connector Type	D-sub 9-pin female	Tx,Rx,RTS,CTS	
GPIOB Interface (Optional)			
Connector Type	IEEE-488 bus connector		
AC Power Input			
Power Source	AC 100 V to 240 V, 50 / 60 Hz Auto range selection		
Battery Pack (Optional)			
Battery pack	6 cells, Li-Ion rechargeable, 3S2P	With UN38.3 Certification	
Voltage	DC 10.8 V		
Capacity	5200 mAh / 56Wh		

General

Internal Data storage	16 MB nominal		
Power Consumption	<82 W		
Warm-up Time	< 45 minutes		
Temperature Range	+5 °C to +45 °C	Operating	
	-20 °C to + 70 °C	Storage	
Weight	4.5 kg (9.9 lb)	Inc. all options (Basic+TG+GPIOB+Battery)	
Dimensions	210 x 350 x 100 (mm) Approximately		
	8.3 x 13.8 x 3.9 (in)		

Tracking Generator⁵ (Optional)

Frequency Range	9 kHz to 3.25 GHz	
Output Power	-50 dBm to 0 dBm in 0.5 dB steps	
Absolute Accuracy	± 0.5 dB	@160 MHz, -10 dBm, Source attenuation 10 dB, 20 to 30°C
Output Flatness	Referenced to 160 MHz, -10 dBm	
	100 kHz to 2 GHz	± 1.5 dB
	2 GHz to 3.25 GHz	± 2 dB
Output Level Switching Uncertainty	± 0.8 dB	Referenced to -10 dBm
Harmonics	< -30 dBc	Typical, output level = -10 dBm
Reverse Power	+30 dBm max.	
Connector type	N-type female	
Impedance	50 ohm	Nominal
Output VSWR	< 1.6:1	300 kHz to 3.25 GHz, source attenuation ≥ 12 dB

[5] The minimum RBW filter is 10kHz when the TG output is ON.

GSP-9330 Dimensions

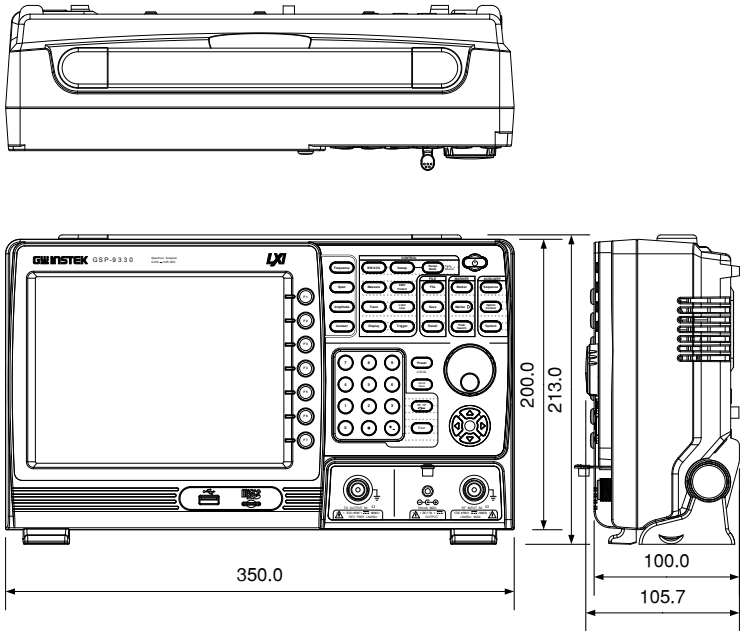

Declaration of Conformity

We

GOOD WILL INSTRUMENT CO., LTD.

declare that the below mentioned product

Type of Product: Spectrum Analyzer

Model Number: GSP-9330

is herewith confirmed to comply with the requirements set out in the Council Directive on the Approximation of the Laws of the Member States relating to the EMC: 2014/30/EU, LVD: 2014/35/EU, WEEE: 2012/19/EU and RoHS: 2011/65/EU.

For the evaluation regarding the Electromagnetic Compatibility and Low Voltage Directive, the following standards were applied:

© EMC	
EN 61326-1: EN 61326-2-1: EN 61326-2-2:	Electrical equipment for measurement, control and laboratory use -- EMC requirements (2013)
Conducted & Radiated Emission EN 55011: 2009+A1: 2010	Electrical Fast Transients EN 61000-4-4: 2012
Current Harmonics EN 61000-3-2: 2014	Surge Immunity EN 61000-4-5: 2014
Voltage Fluctuations EN 61000-3-3: 2013	Conducted Susceptibility EN 61000-4-6: 2014
Electrostatic Discharge EN 61000-4-2: 2009	Power Frequency Magnetic Field EN 61000-4-8: 2010
Radiated Immunity EN 61000-4-3: 2006+A1: 2008+A2: 2010	Voltage Dip/ Interruption EN 61000-4-11: 2004
Low Voltage Equipment Directive 2014/35/EU	
Safety Requirements	EN 61010-1: 2010 (Third Edition) EN 61010-2-030: 2010 (First Edition)

GOOD WILL INSTRUMENT CO., LTD.

No. 7-1, Jhongsing Road, Tucheng Dist., New Taipei City 236, Taiwan

Tel: +886-2-2268-0389

Fax: +866-2-2268-0639

Web: www.gwinstek.com

Email: marketing@goodwill.com.tw

GOOD WILL INSTRUMENT (SUZHOU) CO., LTD.

No. 521, Zhujiang Road, Snd, Suzhou Jiangsu 215011, China

Tel: +86-512-6661-7177

Fax: +86-512-6661-7277

Web: www.instek.com.cn

Email: marketing@instek.com.cn

GOOD WILL INSTRUMENT EURO B.V.

De Run 5427A, 5504DG Veldhoven, The Netherlands

Tel: +31(0)40-2557790

Fax: +31(0)40-2541194

Email: sales@gw-instek.eu

INDEX

2FSK	155	CNR	181
Accessories	12	Composite second order	184
ACPR	125	Composite triple beat	185
Adjacent channel power	125	Conventions	34
Alarm output	118	CSO	184
AM Analysis	129	CTB	185
AM/FM demodulation sound out	140	Date, Time, Wake-up clock	30
Amplitude		Declaration of conformity	341
Amplitude correction	53	Decoding	
Attenuation	49	ASK	145
Auto scale	50	FSK	152
Correction	54	Default settings	285
Input impedance	59	Demo Kit	244
Pre-amplifier	60	Activation	246
Reference level	48	ASK	244
Reference level offset	52	FSK	246
Scale	50	Display	
Scale/div	49	Backlight	106
Vertical scale unit	52	Brightness	106
View scale	51	Display mode	
ASK measurement	141	Setting	108
Autoset	62	Spectrogram	109
Horizontal settings	63	Topographic	110
Vertical settings	63	Reference level line	107
Average		Spectrogram markers	111
Trace	67	Spit spectrum view	113
Type	68	Topographic markers	111
Bandwidth		Video out	107
RBW	64	Display diagram	21
VBW	65	Disposal instructions	6
VBW/RBW ratio	66	Disposal symbol	3
Battery		EMC	
Safety instruction	5	AC Voltage probe	216
Battery insertion	27	EMI Test	202
Carrier to noise ratio	181	EMS Test	219
Caution symbol	3	Field Sensor	210
Cleaning the instrument	5	Overview	201
		Source Contact probe	213
		EMI Filter	69

EN61010	Deletion	226
Measurement category	Overview	222
Pollution degree.....	Pass/fail testing	227
Environment	List of features	9
Safety instruction.....	Manchester Decoding	
FAQ	ASK	145
File	FKS.....	152
Copy files.....	Marker	
Correction data	Delta markers	93
Delete files	Functions	
File explorer	Frequency counter.....	96
File types.....	Noise	95
Image preview	VSWR.....	97
Limit line data.....	Move to trace	98
Move files	Moving delta markers	94
Overview	Moving markers manually	92
Power meter data	Moving markers to preset	
Quick save.....	positions	92
Recall files.....	Moving reference markers.....	94
Rename files.....	Normal marker.....	91
Save files	Peak configuration.....	103
Screen files.....	Peak search	100
Sequence data	Peak table.....	104
Sort files	Table	99
State data	Marketing	
Trace data	Contact	281
Firmware update	Measurement	
First time use instructions	2FSK	
FM Analysis.....	pass fail	157
Frequency	2FSK.....	155
Center frequency	ACPR.....	125
Center frequency step	AM Analysis.....	129
Frequency offset	pass fail	133, 147, 154
Start frequency	AM/FM demodulation sound	
Stop frequency	out	140
Front panel diagram.....	ASK	141
FSK measurement.....	ASK decoding.....	145, 152
Glossary	CNR	181
GPIO function check	CSO.....	184
Ground	CTB	185
Symbol.....	FM Analysis.....	135
Harmonic measurement	pass fail	139
Image preview	FSK.....	148
LAN function check	Harmonics.....	187
Language	NdB bandwidth.....	190
Limit lines	OCBW.....	128
Creation	Overview.....	123
	P1dB measurement	191
	P1dB normalization	195, 198
	Phase Jitter	159

SEM.....	173	Settings.....	120
3GPP.....	176	User settings.....	119
802.XX.....	178	Quick save	264
Overview.....	161	RBW.....	64
User.....	174	Rear panel diagram	19
TOI.....	179	Remote control.....	266
Menu tree		GPIB configuration.....	267
Amplitude.....	287	Hislip.....	270
Autoset	289	LAN configuration	268
BW Avg	289	LXI password	269
Control options.....	300	RS232C configuration.....	275
Display.....	293	USB configuration.....	267
EMC Pretest	327	WLAN configuration	271
File.....	302	Remote control function check.....	275
Frequency.....	289	Replace the clock battery	282
Limit line	290	Restore default settings.....	33, 119
Marker	294	SEM	
Measure	309	3GPP.....	176
Options.....	300	802.XX	178
Recall.....	307	Overview	161
Save.....	304	User	174
Sequence.....	291	Sequeunce	
Span	289	Editing.....	229
Sweep.....	289	Overview	229
System	296	Running	233
Trace	292	Service operation	
Trigger.....	291	About disassembly	4
Miller Decoding		Contact.....	281
ASK.....	145	Span	
FSK.....	152	Full span	46
NdB bandwidth.....	190	Last span.....	47
OCBW	128	Setting	45
Occupied bandwidth	128	Zero span.....	46
P1dB measurement	191	Specifications.....	332
P1dB normalization.....	195, 198	Amplitude	333
Peak search.....	100	Dimensions.....	340
Peak table	104	Frequency	332
Phase Jitter.....	159	General.....	338
Power down.....	29	Input/output.....	336
Power meter		RF amplifier.....	336
Activation.....	239	Sweep	336
Data logging.....	241	Tracking generator	339
Power on/off		Spectrum emission mask testing.....	173
Safety instruction	5	Status icons	24
Power up	28	Sweep	
Pre-amplifier	60	Continous sweep	71
Preset.....	119	Gated sweep.....	72
Power on settings	120	Single sweep.....	71

Sweep Control.....	75	Selecting trace.....	77
Sweep Mode.....	75	Type.....	77
Sweep time.....	70	Tracking generator	
System		Activation.....	234
Alarm output.....	118	Normalization.....	235
Date & time.....	116	Trigger	
Date & time display.....	117	Delay.....	89
Set language.....	116	External trigger.....	87
System information.....	115	Free run.....	85
View error messages.....	115	Mode.....	88
Wake-up clock.....	117	Video trigger.....	85
THD.....	187	UK power cord.....	7
Third order intermodulation		USB function check.....	280
distortion.....	179	VBW.....	65
Tilting stand.....	26	VBW/RBW ratio.....	66
TOI.....	179	Video out port.....	107
Trace		Warning symbol.....	3
Detection modes.....	81	Web server function check.....	276
Icons.....	78		
Math.....	79		