

BROCHURE

PNA and PNA-L Series Microwave Network Analyzers

The standard in microwave network analysis



 **KEYSIGHT**
TECHNOLOGIES

Table of Contents

PNA Family Sets the Standard for Microwave Network Analysis.....	3
Complete Solutions for a Wide Range of Applications	4
Innovative Features Across the PNA Family.....	5
Connectivity to Match Your Application.....	6
PNA Series.....	7
Choose the Right Hardware for Your Test Needs	9
PNA Series Innovative Applications.....	10
Innovative Applications.....	12
One-box solution for high-speed serial interconnect analysis (S93011B)	23
PNA Series Innovative Applications.....	24
PNA-L: Passive and Active Device Test at Affordable Prices	26
PNA-L Series Block Diagrams.....	27
PNA-L Series:	
The Economical Choice for Signal Integrity and Material Measurements	28
On-Wafer Measurements with the PNA Family	29
Extend the Power of the PNA Family to Multiport Devices.....	30
Completing the Solution.....	31
Ordering Information	33

PNA Family Sets the Standard for Microwave Network Analysis

Choose the leader

The PNA family builds on Keysight's 45-year legacy of excellence in network analysis to deliver new standards in performance, speed, accuracy, and versatility for microwave component test. The PNA family includes:

PNA-X Series – Keysight's most advanced and flexible network analyzer, providing complete linear and nonlinear component characterization in a single instrument with a single set of connections

PNA Series – the industry's highest performing network analyzer, offering many advanced measurement applications

PNA-L Series – designed for S-parameter and simple nonlinear testing of passive components, amplifiers, and frequency converters

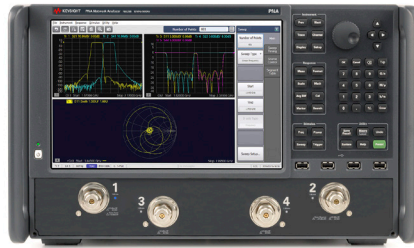

PNA-X Series Network Analyzers

- N5249B 900 Hz /10 MHz to 8.5 GHz
- N5241B 900 Hz /10 MHz to 13.5 GHz
- N5242B 900 Hz/10 MHz to 26.5 GHz
- N5244B 900 Hz /10 MHz to 43.5 GHz
- N5245B 900 Hz/10 MHz to 50 GHz
- N5247B 900 Hz/10 MHz to 67 GHz

PNA Series Network Analyzers

- N5221B 900 Hz /10 MHz to 13.5 GHz
- N5222B 900 Hz/10 MHz to 26.5 GHz
- N5224B 900 Hz /10 MHz to 43.5 GHz
- N5225B 900 Hz /10 MHz to 50 GHz
- N5227B 900 Hz/10 MHz to 67 GHz

PNA-L Series Network Analyzers

- N5239B 300 kHz to 8.5 GHz
- N5231B 300 kHz to 13.5 GHz
- N5232B 300 kHz to 20 GHz
- N5234B 10 MHz to 43.5 GHz
- N5235B 10 MHz to 50 GHz

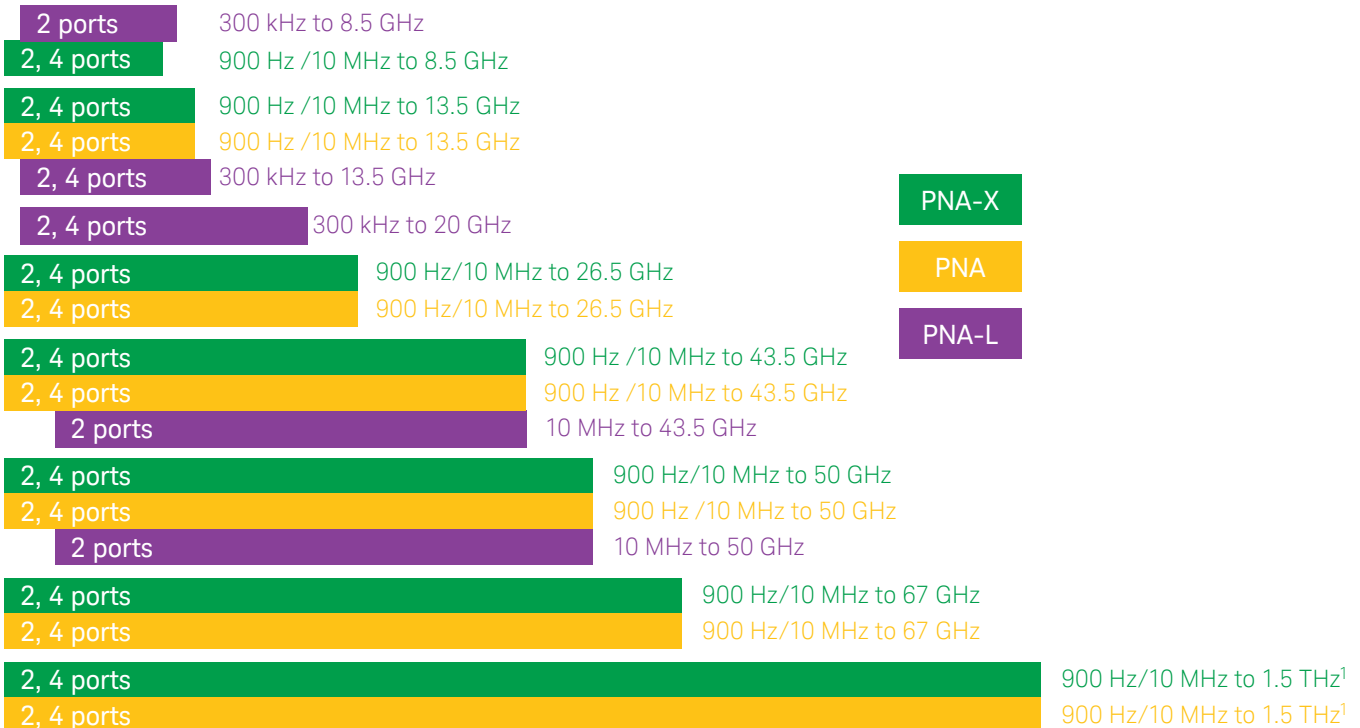

1. With frequency extenders

Complete Solutions for a Wide Range of Applications



In addition to being very capable standalone network analyzers, PNA and PNA-L instruments often form the core of more advanced measurement systems to serve a variety of microwave measurement applications.

Future-proof your microwave component testing

All members of the PNA family share a common software platform that makes it easy to choose just the right level of performance to match your budget and measurement needs. This commonality guarantees measurement consistency and repeatability and a common remote-programming interface across multiple instruments in R&D and manufacturing. All of the powerful PNA software applications can be added later to meet future test requirements.

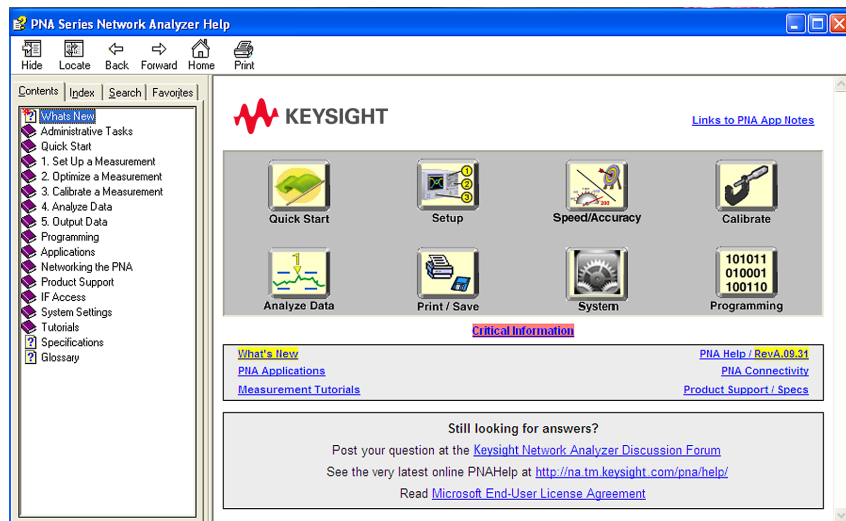

The PNA's built-in help system provides a complete user's guide, including measurement tutorials and programming documentation.

Innovative Features Across the PNA Family

Flexible, modern user interface: front panel keys, tabbed soft panel, pulldown menus, customizable toolbar, right-click shortcuts, drag-and-drop operation, and 12.1" touch screen

Up to 15 markers per trace

State-of-the-art calibration capabilities

200 measurement channels and unlimited traces

Context sensitive, built-in help

Undo/Redo cancels or restores previous entries

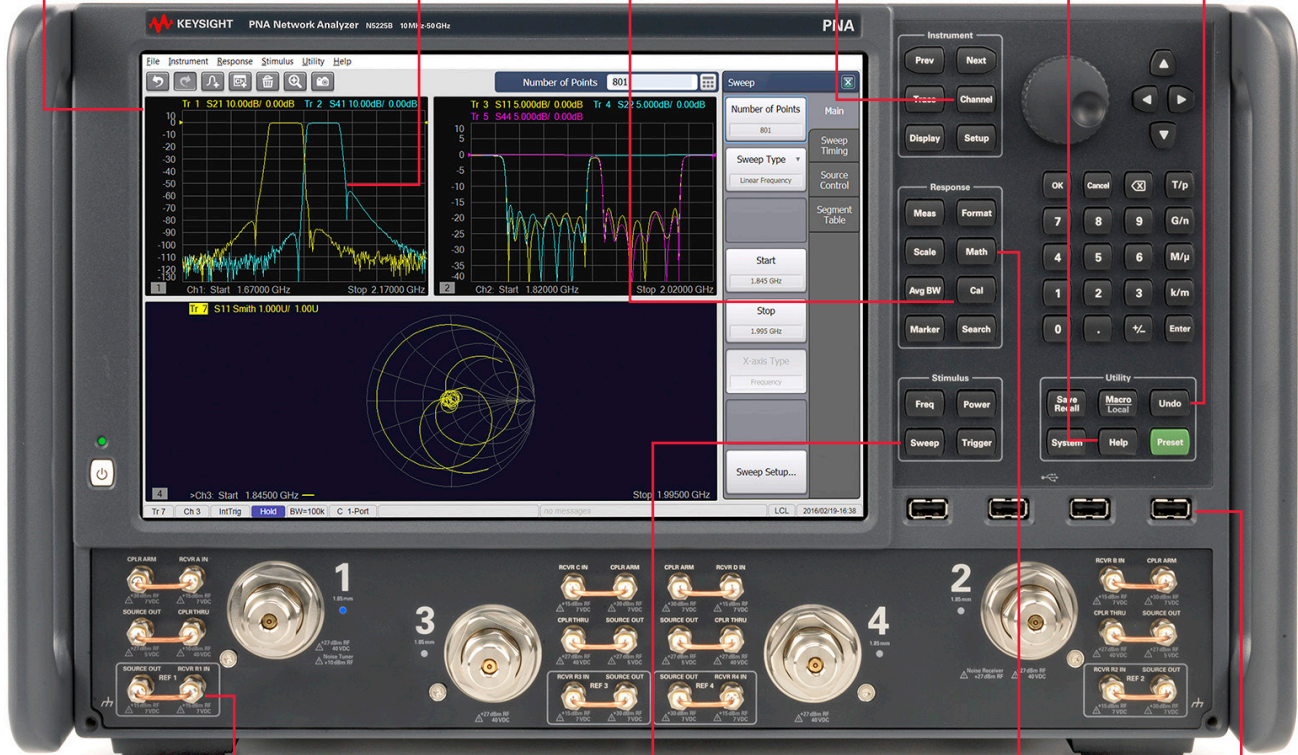

Configurable test set available on all models

Linear, log, power, CW, phase, and segment sweep

Equation editor and time-domain analysis

Quick access for ECal and other USB devices



All PNA models integrate a high resolution display with a touch screen, which provides a crisp view and easy access to all data and traces. This enhanced user interface allows intuitive operation and helps you set up complex measurements quickly.

Connectivity to Match Your Application

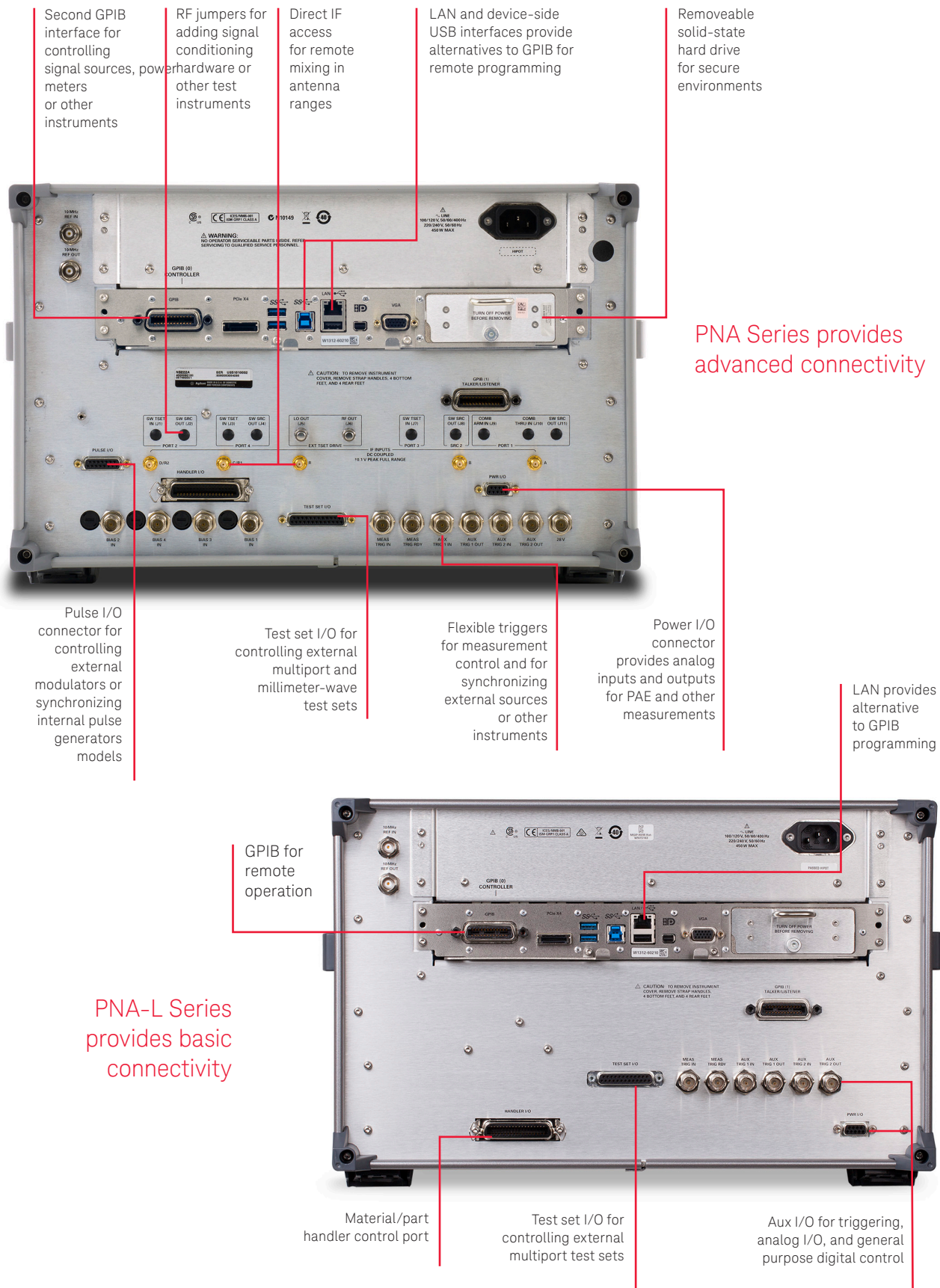

PNA Series provides advanced connectivity

PNA-L Series provides basic connectivity

PNA Series

The PNA Series of network analyzers offers industry-leading performance for testing amplifiers, mixers and frequency converters. The PNA Series provides a winning combination of excellent hardware and powerful measurement applications to measure a broad range of devices fast and accurately. All models are available in 2-port single-source and 4-port dual-source versions. Pulsed S-parameters are easy using built-in pulse modulators and pulse generators.

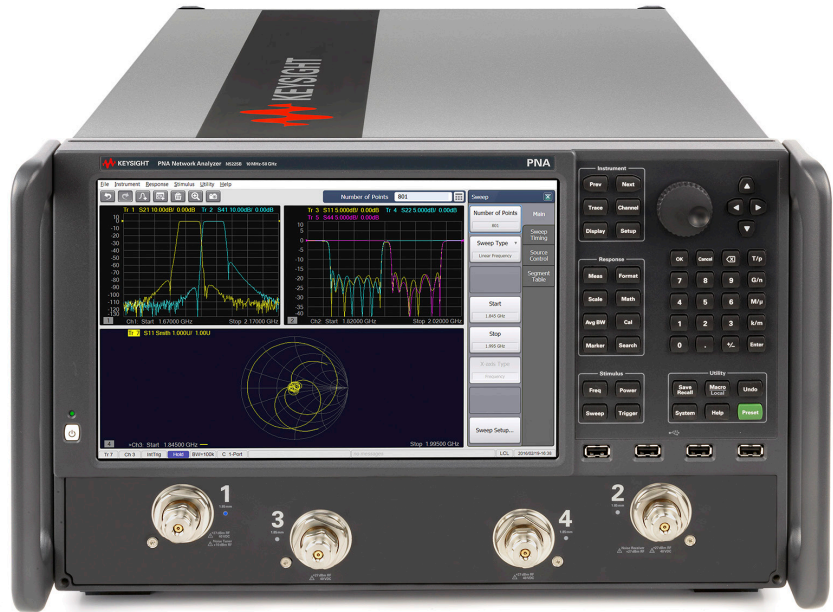

Highest performance

- High source output power of +13 dBm at 1 GHz to +11 dBm at 67 GHz
- High dynamic range: 134 dB at 20 GHz at test port
- Low trace noise: 0.002 dB rms at 1 kHz bandwidth
- Low receiver noise floor
- High receiver compression level
- Fast measurement speed: 3.6 to 23 μ sec/point
- High stability: < 0.03 dB/°C

Advanced applications

Many of the measurement applications developed for the PNA-X are now available for the PNA, such as:

- Device Measurement eXpert (DMX) (S94601B/S94602B)
- Real-time S-parameter and power measurement uncertainty (S93015B)
- Pulsed-RF (S93025/26B)
- Gain compression (S93086B)
- Intermodulation distortion (S93087B)
- Noise figure using standard receivers (S93029B)
- Source-phase control (S93088B)
- Differential and I/Q Devices (S93089B)
- True-mode stimulus (S93460B)
- Frequency converters (S93082/83B)
- Embedded-LO (S93084B)
- Automatic fixture removal (S93007B)
- Spectrum analysis (S9309xxB)

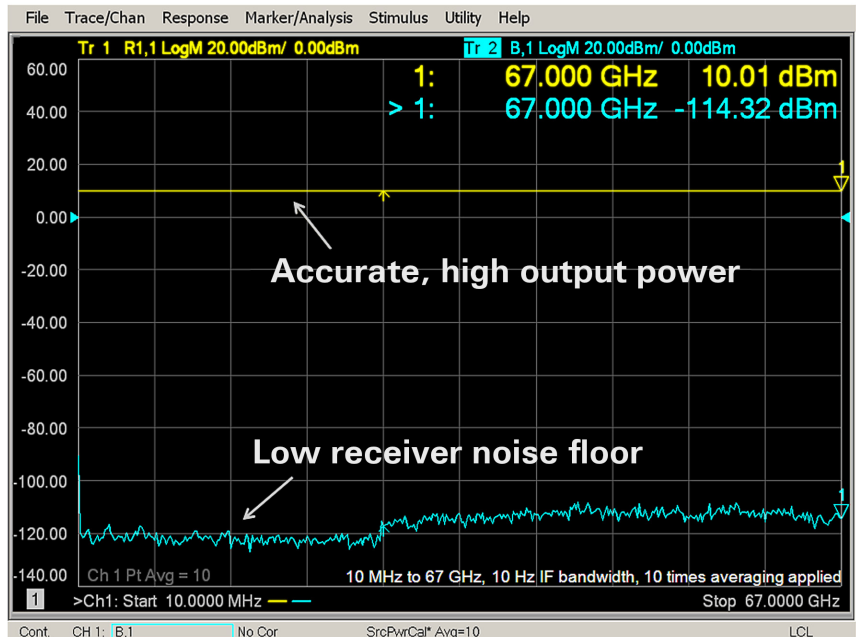

With receiver-leveled output power of +10 dBm and a receiver noise floor of -114 dBm, the PNA typically has 124 dB of dynamic range at 67 GHz, more than any other network analyzer in this frequency range.

PNA Series

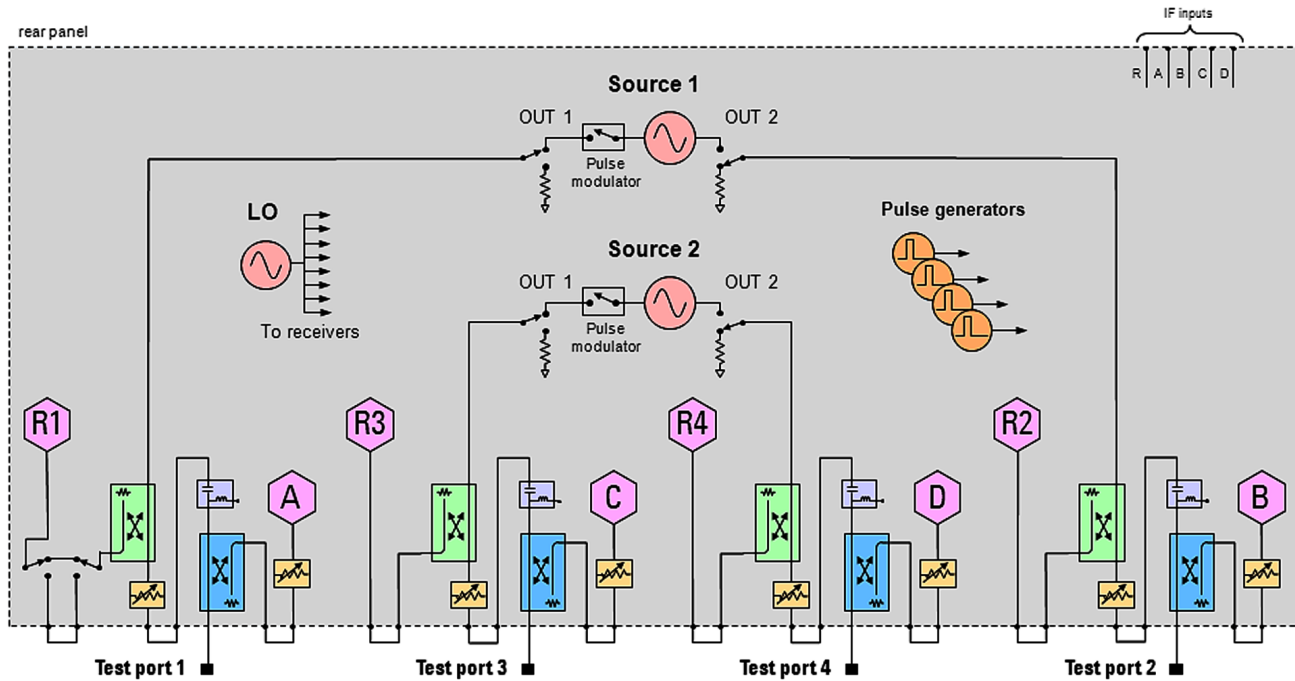

PNA Series block diagram shown with test set Option 419, plus pulse and external-IF options.

Performance	Legacy PNA E836x	New PNA N522x
Port power, 20 GHz	+3 dBm	+13 dBm
System dynamic range, 20 GHz	123 dB	127 dB
Receiver compression, 0.1 dB	-5 dBm	+12 dB
Source power sweep range	27 dB	38 dB
Minimum pulse width, wideband detection	50 us	100 ns

The new PNA Series network analyzers offer significantly better performance compared to legacy models.

Refer to the PNA family configuration guide, 5992-1465EN, for the low frequency extension diagrams and the option availability.

Choose the Right Hardware for Your Test Needs

	Legacy PNA-L N5230C/ PNA-L N523xB	Legacy PNA E836x	PNA N522xB	PNA-X N524xB
2-ports, single source	■	■	■	■
2-ports, dual source				■
4-ports, dual source	■ ¹		■	■
Low-harmonic sources (< -60 dBc)				■
Test set without front-panel RF loops	■	■	■	
Test set with front-panel RF loops	■	■	■	■
Switchable rear-panel RF loops				■
Source attenuators	■	■	■	■
Receiver attenuators		■	■	■
Bias tees		■	■	■
Low frequency extension to 900 Hz			■	■
External IF inputs		■	■	■
RF, LO outputs for millimeter extenders		■	■	■
Internal pulse modulators			■	■
Internal pulse generators			■	■
IF gates for narrowband pulse detection		■	■	■
R1 reference receiver switch		■	■	■
Internal signal combiner				■
Noise figure using standard receivers			■	■
Noise figure using low-noise receivers				■
Nonlinear vector network analyzer applications				■

1. Dual source is only available on legacy PNA-L N5230C 13.5 and 20 GHz, 4-port.

More information about the PNA-X can be found online at www.keysight.com/find/pna-x or in the PNA-X Series brochure, 5990-4592EN

PNA Series Innovative Applications

Powerful measurement setup assistance, Device Measurement eXpert (DMX) (S94601B/S94602B)

Measurement challenges

- Inexperienced users find it difficult to setup complex measurements
- PNA is so flexible/capable that the users need to have a lot of knowledge/experience to optimally set up the measurement.
- When making a number of different measurements for active devices (noise figure, gain compression, IMD...), there are many common settings that the users have to repeatedly configure for each measurement.
- The users need to know the limits of the instrument performance as well as the operating conditions of their DUTs to set up measurements in a safe and optimal manner.

Device Expert and S94601B DMX (Device Measurement eXpert) application

- Helps the users to set up the measurements automatically based on selected DUT. Device Expert, included with the base PNA software, provides three DUT types: low noise amplifier, mixer, and bandpass filter. The S94601B DMX provides many more DUT types than the built-in Device Expert. Once a DUT is selected the measurements and parameters configured in the template are listed. The users can modify the measurements and parameters using S94601B DMX or the DMX template editor.
- Assists the users in consistently configuring measurement settings throughout the design and test workflow by using a common template.
- Allows the users to create customized templates for their measurement needs.
- Provides intelligent algorithms that optimize measurement setups based on instrument and DUT performance limitations, protecting both the DUT and the instrument.

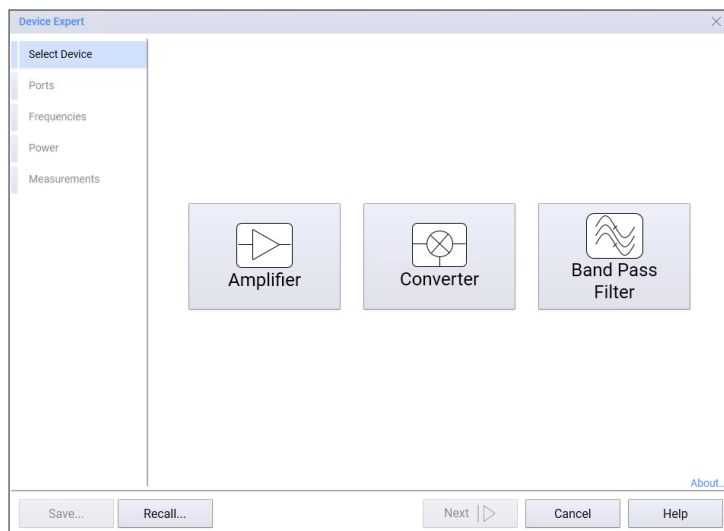
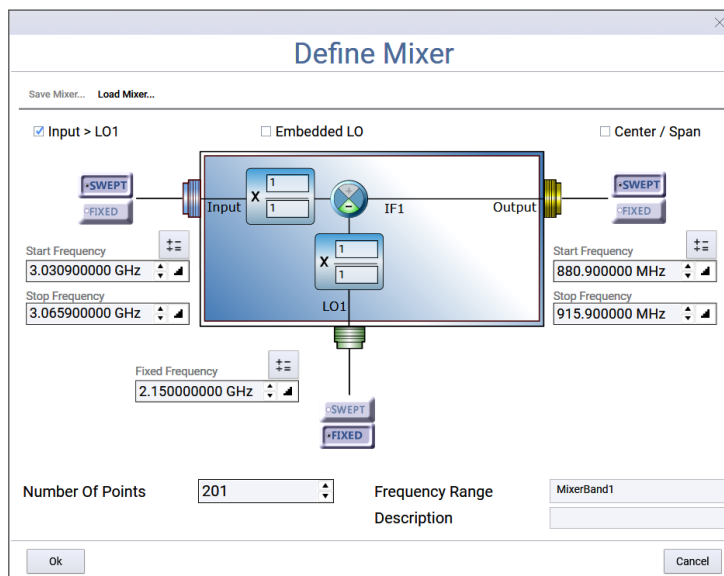
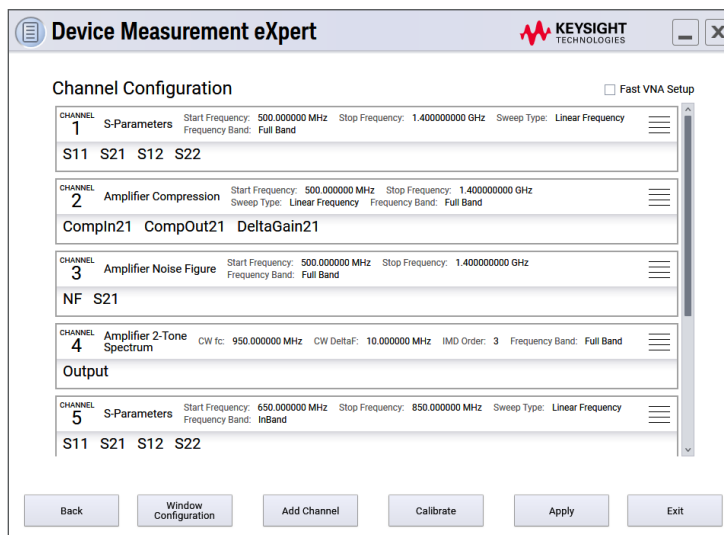

S96402B DMX Limit Assistant application

- Provides an intuitive and convenient graphical interface where users can create limit masks for complex limit test conditions for production test applications using data from a PNA or data file in csv, s2p, or prn format.



Innovative Applications

Real-time S-parameter and power measurement uncertainty (S93015B)

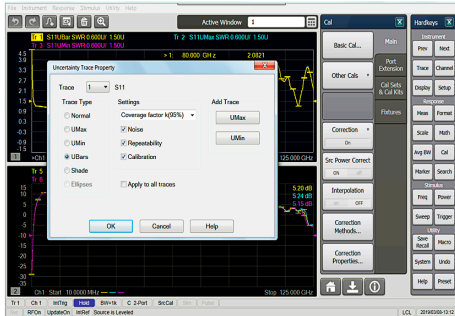

S93015B uncertainty model includes multiple uncertainty factors: noise, calibration standards, power sensor, and repeatability.

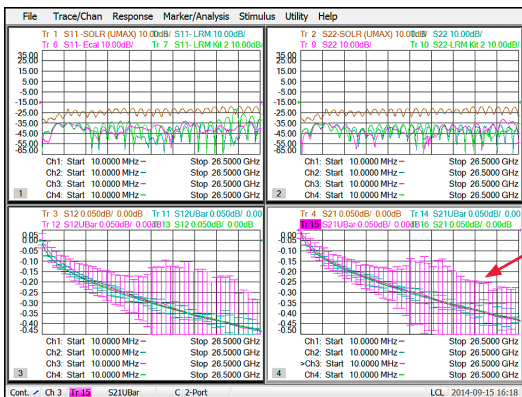

Real time uncertainty with measurement traces and uncertainty bars

Product performance verification challenges

- Need to calculate the measurement uncertainty including multiple uncertainty factors
- Hard to optimize limit lines for pass/fail tests
- Quality control procedure is not simple due to complexity of quantifying the quality of the measurement process.

PNA/PNA-L's real-time S-parameter and power measurement solution

- Provides real-time S-parameters and power measurements uncertainty on the display
- Enables more realistic limit lines and reduce the defect percentage on the finished products for better production yield rates
- Includes the calibration standard uncertainty and provides the national metrology institute traceability
- Establishes a metric to quantify the quality of the measurement process for quality-control-procedure simplification
- Helps to include uncertainty information to the users' product specifications and datasheets
- Allows users to save measurement data and evaluate other parameters with fully correlated uncertainty

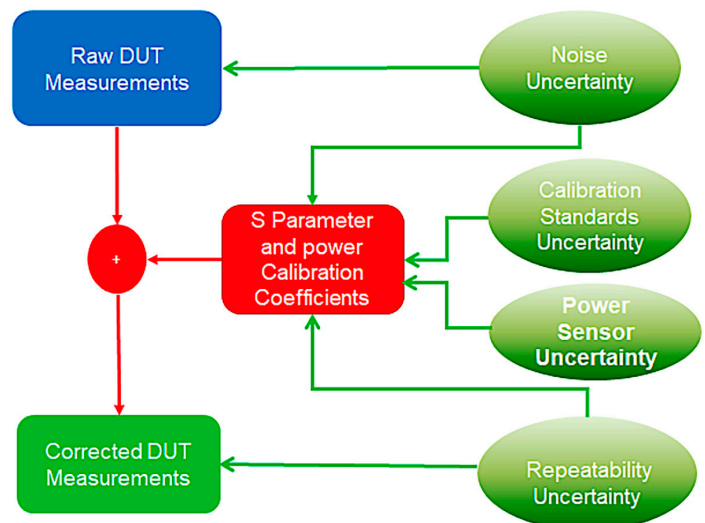

Error (uncertainty) bars are given on the measurement traces

The users can select the uncertainty factors and the coverage factors depending on the application.

Tips from the experts

- Prior to using the uncertainty calibration, ensure that you have set up the correct number of points, IFBW and power for the device you want to measure. This will avoid invalidation of your uncertainties as a result of changing any of these parameters after doing a calibration.
- It is recommended that you do a standard calibration prior to using the Uncertainty Manager, as this will make it more efficient when you start the repeatability-characterization process.
- When using the uncertainty manager to characterize the repeatability of the measurement, consider providing a unique label for each port. This way you can save the noise and repeatability for each of the ports you will be using in the final measurement. As an example, use "Lab System Port 1" as the cable name, and assign the appropriate connector.
- When viewing 1-port uncertainties, it is best to use the linear format as opposed to the log format.

PNA Series Innovative Applications

Simple, fast, and accurate pulsed-RF measurements (S93025/026B, Options 021, 022)

Pulsed-RF measurement challenges

- Pulse generators and modulators required for pulsed-RF measurements add complexity in test setups
- For narrow pulses:
 - Maximum IF bandwidth of analyzer is often too small for wideband detection
 - Narrowband detection is slow, and measurements are noisy for low duty cycle pulses



The PNA is a one-box pulsed-RF test solution that is simple to use and provides fast, accurate pulsed-RF characterization.

PNA pulsed-RF measurements provide:

- S93025B provides a simple user interface for full control of two internal pulse modulators (Options 021 and 022), and four internal independent pulse generators, and point-in-pulse measurements with pulse widths as narrow as 200 ns, and pulse-profile measurements with 50 ns minimum resolution.
- S93026B adds point-in-pulse measurements with 20 ns minimum pulse width, and pulse profile measurements with 10 ns minimum resolution
- Improved measurement speed and accuracy for narrowband detection using hardware filters and patented spectral-nulling and software IF-gating techniques
- Measurements using wideband detection with pulse widths as narrow as 100 ns
- Receiver leveling for accurate source-power control
- Pulse I/O connector on rear panel for synchronization with external equipment and DUT
- Accurate active-component characterization using unique application measurement classes for gain compression, swept-frequency/power IMD, and noise figure

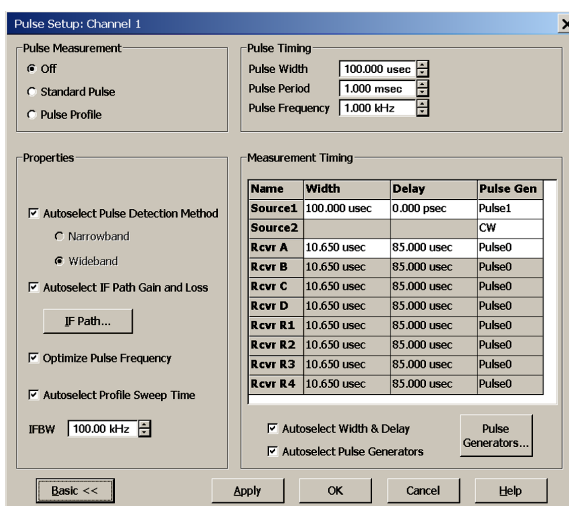

The pulsed-RF measurement application automatically optimizes the internal hardware configuration for specified pulse conditions to dramatically simplify test setups. Alternately, users can choose to manually set up the hardware for unique test requirements.

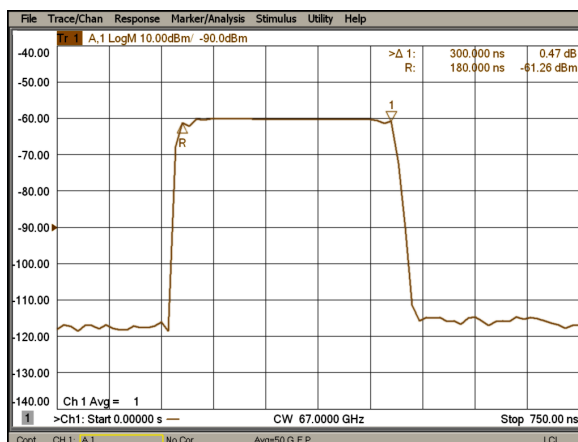

Pulse profile measurement using narrowband detection method allows 300 ns sweep time with 30 data points.

PNA Series Innovative Applications

Fast, accurate gain compression versus frequency measurements of amplifiers and converters (S93086B)

Gain compression measurement challenges

- Characterizing amplifier or frequency converter compression over its operating frequency range requires measurements at many frequency and power points, so setting up the measurements, calibration, and data manipulation takes a lot of time and effort
- A variety of errors degrade measurement accuracy, such as mismatch between the test port and the power sensor and DUT during absolute power measurements, and using linear S-parameter error correction in nonlinear compression measurements

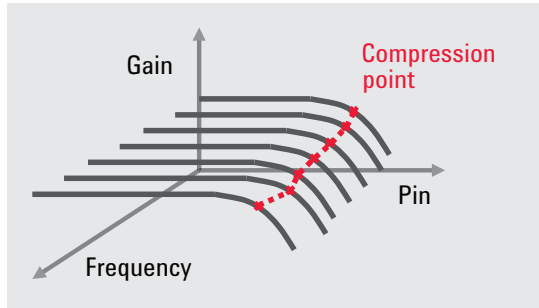

A network analyzer is commonly used for gain compression measurements by performing power sweeps at multiple CW frequencies. The PNA's GCA makes it easy to characterize compression over the DUT's operating frequency range with extreme speed and accuracy, and a simple setup.

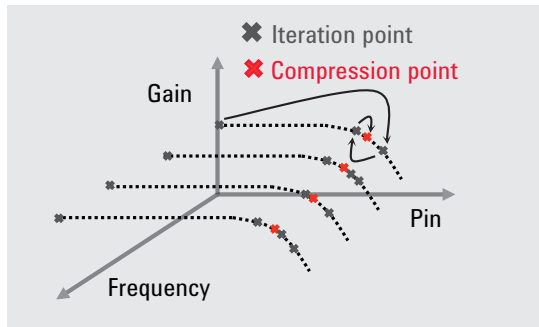

Instead of a linear power sweep with many points, GCA's SMART Sweep uses an adaptive algorithm to find the desired compression point at each frequency with just a few power measurements, thus significantly reducing test times.

PNA gain compression application (GCA) provides:

- Fast and convenient measurements with SMART Sweep, which greatly reduces the number of power points required to fully characterize compression versus frequency
- Highly accurate results using a guided calibration that provides power and mismatch correction
- Complete device characterization with two-dimensional (2D) sweeps, with the choice of sweeping power per frequency, or frequency per power
- Flexibility with a variety of compression methods—compression from linear gain, maximum gain, X/Y compression, compression from back-off, or compression from saturation

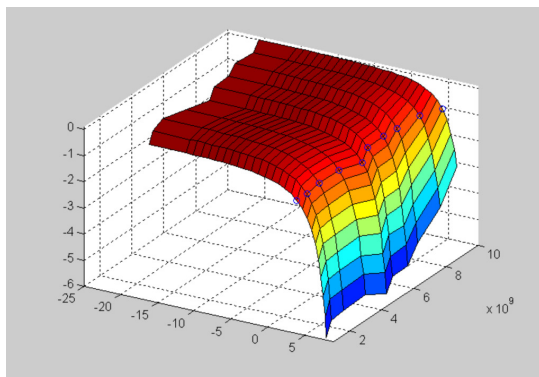
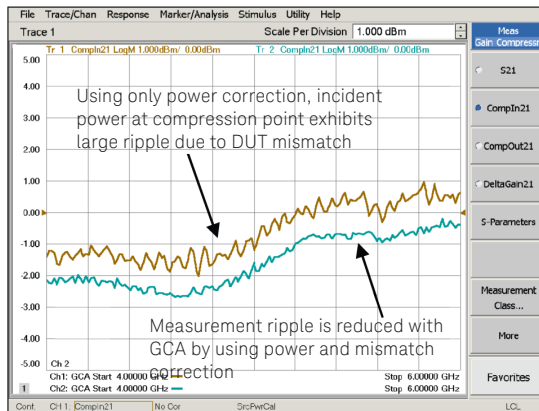

Complete device response to 2D sweeps—gain versus frequency and power—can be extracted for device modeling.

PNA Series Innovative Applications

Fast two-tone intermodulation distortion (IMD) measurements with simple setup (S93087B)

IMD measurement challenges

- Two signal generators, a spectrum analyzer, and an external combiner are most commonly used, requiring manual setup of all instruments and accessories
- Test times are slow when swept-frequency or swept-power IMD is measured
- Instruments and test setups often cause significant measurement errors due to source-generated harmonics, cross-modulation, and phase noise, plus receiver compression and noise floor

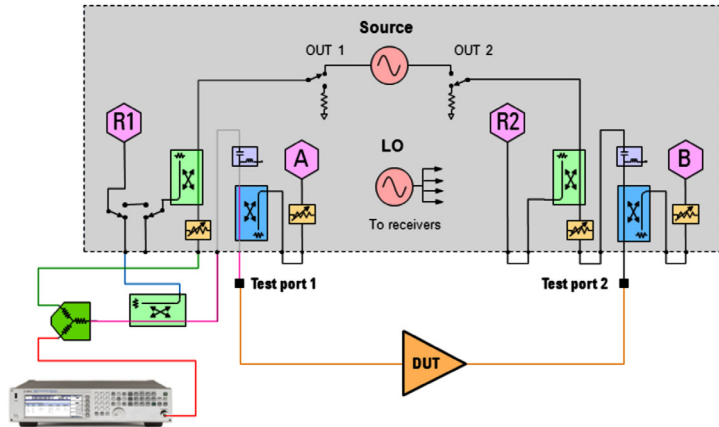

A 2-port PNA can be used with an external signal source, combiner and coupler for IMD measurements.

PNA IMD application provides:

- Fast swept-IMD measurements of amplifiers and frequency converters
- Quick and easy measurements with an intuitive user interface
- Guided calibration that simplifies the calibration procedure and provides high measurement accuracy
- Spectrum analyzer mode for troubleshooting or making spurious measurements, eliminating the need for a separate spectrum analyzer

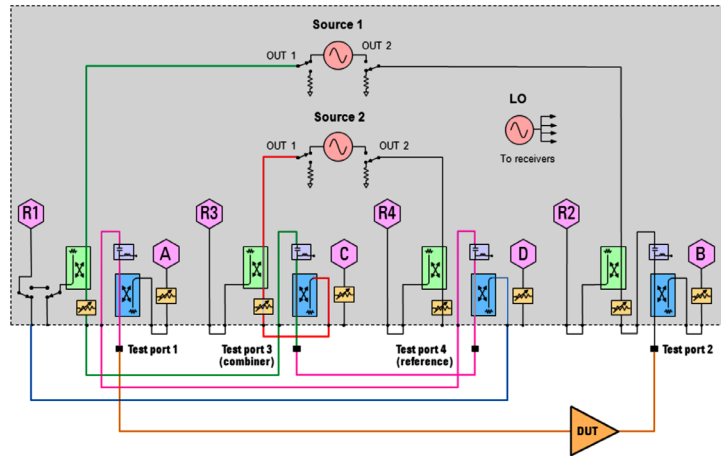

On a 4-port PNA, the two internal sources can be used to create the IMD stimulus. Unused test port couplers can be used as a combiner and reference coupler.

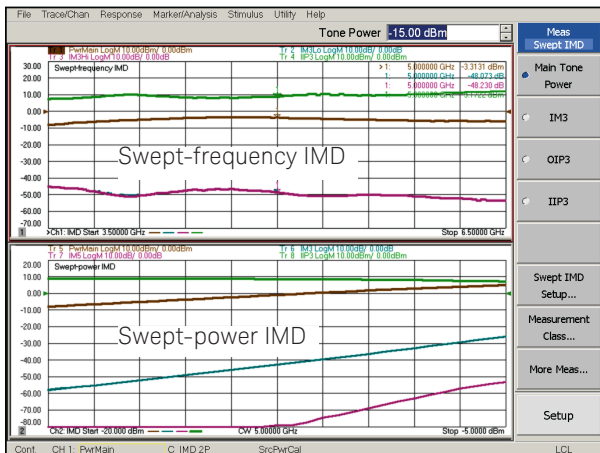

IMD application measures third order IMD and IP3 at 201 frequency (or power) points in a matter of seconds, compared to several minutes using signal generators and a spectrum analyzer.

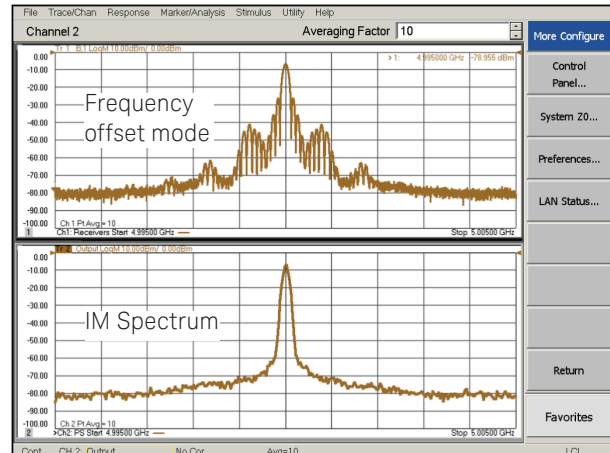

Frequency-offset mode is commonly available in VNA's, but conventional IF filter responses exhibit high side lobes. The IM Spectrum mode employs an optimized digital-IF filter along with software preselection, to provide true spectrum measurement capability in the PNA. A faster and more capable spectrum analyzer application is available with S93090xB.

Innovative Applications

Fast multi-channel spectrum analyzer for component characterization
(S93090x/093/094B)

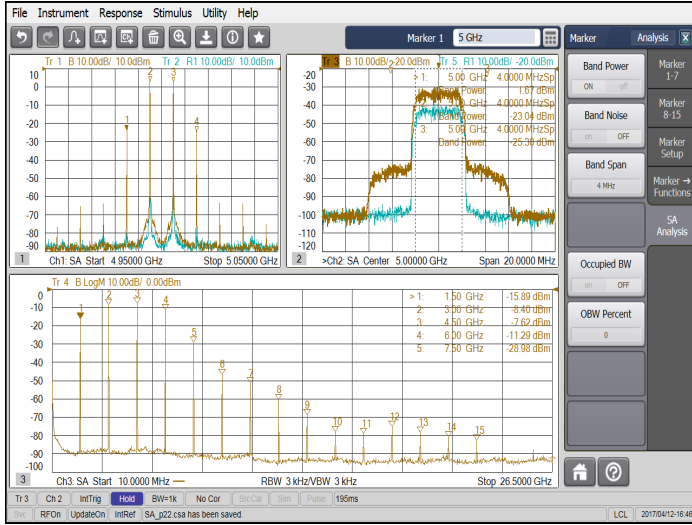
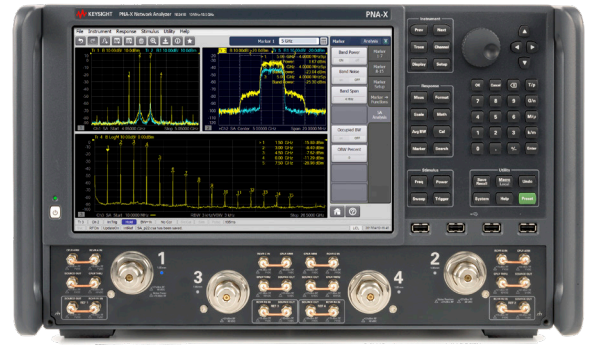

Spectrum analyzer option adds fast spur search capability to the PNA/PNA-L, replacing a standalone spectrum analyzer and switch matrix in component-characterization test systems.

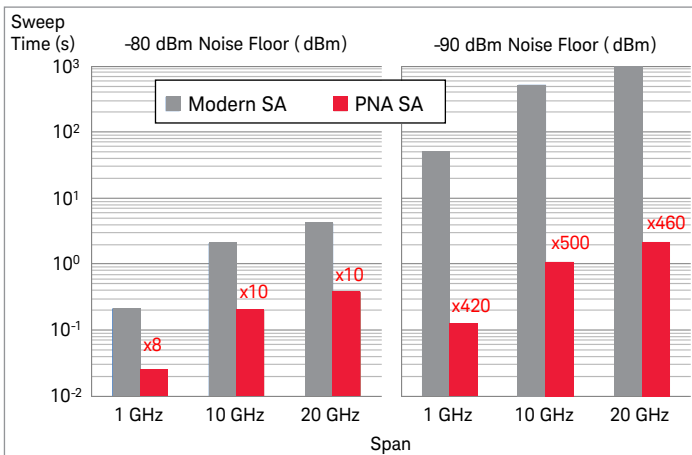

Sweep time versus span with 12 GHz center frequency for -80 dBm and -90 dBm noise floor. The receiver attenuator is set to avoid compression with a +10 dBm signal.

Spectrum analysis challenges for component testing

- Measuring spurious performance is time consuming, especially when searching for low-level spurs over a broad frequency range
- Long measurement times may force insufficient test coverage
- Characterizing spurs over operating range of the DUT is tedious to accomplish or requires external control software

PNA/PNA-L spectrum analyzer (SA) application provides:

- Fast spurious searches over broad frequency ranges
- A multi-channel SA with internal swept-signal generators for efficient spurious analysis of mixers and converters
- In-fixture spectrum measurements using VNA calibration and de-embedding techniques
- Fast band- and noise-power measurements
- SA capability to the PNA/PNA-L's single-connection, multiple-measurement suite



Above plot shows -84 dBm spurious measurements in the presence of a +10 dBm signal, with (from top to bottom) approximate S/N (at RBW) of 80 dB (300 kHz), 90 dB (30 kHz), 100 dB (3 kHz), and 110 dB (300 Hz).

Providing multi-channel spectrum analysis

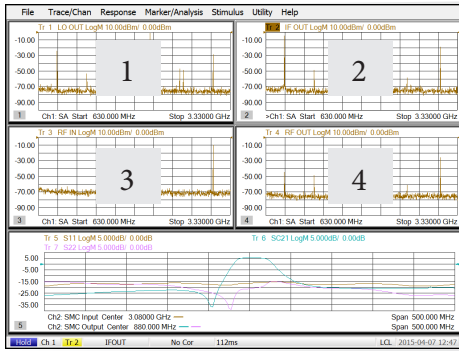

Having spectrum analyzers on all ports of a mixer or converter provides unparalleled insight into the performance of the device. With a single set of connections, the spurious content emanating from all ports is readily apparent during operation with fixed or swept stimuli. Measured spurs can include LO, RF, and IF feedthrough, harmonics, intermodulation products, and other higher-order mixing products. Conversion loss and match versus frequency is easily seen in a companion SMC channel (bottom).

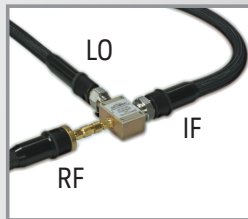

Unlock true performance with VNA calibration

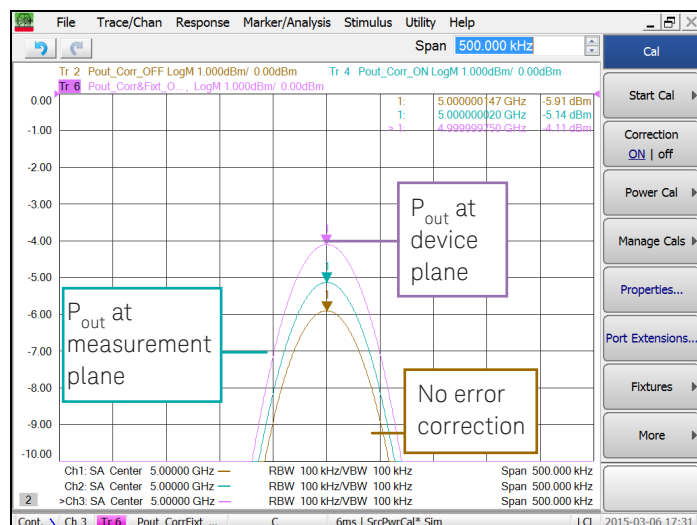
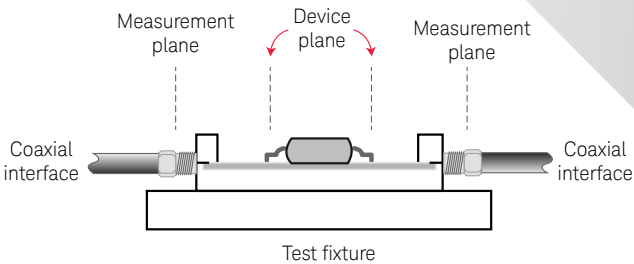

VNA calibration and fixture de-embedding remove cable and fixture effects and correct receiver response errors, providing calibrated in-fixture spectrum analysis.

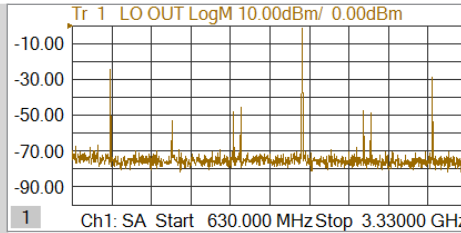

Output spectrum on LO port

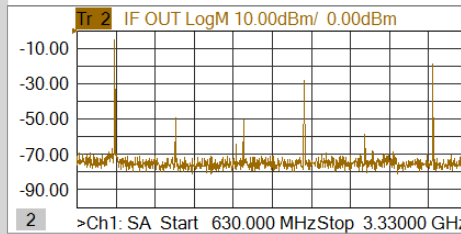

Output spectrum on IF port

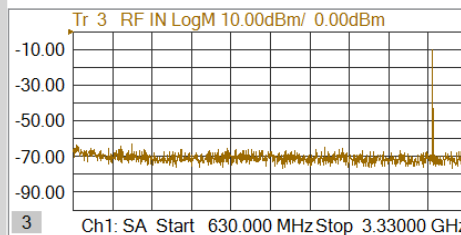

Input spectrum on RF port

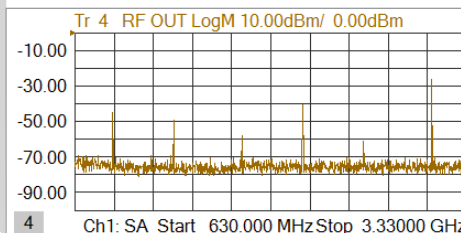

Output spectrum on RF port

Tips from the experts

- Choose different levels of software-image rejection to trade-off measurement speed with thoroughness, based on the spectral density of the measurement
- For harmonics measurements, add a separate SA channel for each harmonic with a narrow frequency span and RBW to optimize speed and sensitivity, and with enough receiver attenuation to avoid internally-generated harmonics
- To help identify spurious signals that might be interfering with a measurement, use the Marker-to-SA feature to easily create a spectrum display with the same stimulus conditions at the marker position in SMC, swept-IMD, or standard channels
- When using de-embedding to measure in-fixture or on-wafer devices, use the power-compensation feature to overcome the loss of the fixture or probes, thereby delivering a known stimulus power to the DUT

Innovative Applications

New capability of spectrum analysis application – Noise Power Ratio (NPR) measurements (S93090x/093/094B)

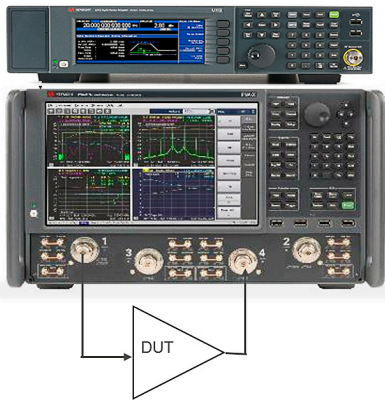

Classic NPR measurement with PNA/PNA-L and UXX

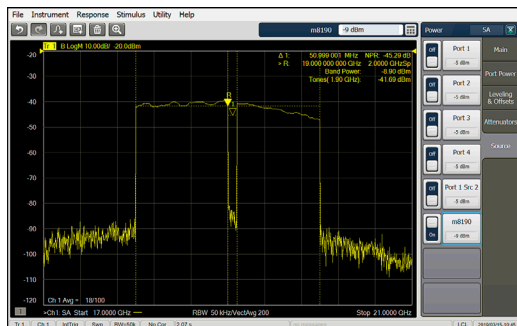

Before the signal correction



Improved flatness and lower noise floor in the notch after signal correction

Challenges for amplifier noise power ratio (NPR) measurements

- It requires a spectrum analyzer for the analysis, and the measurement takes a long time due to the need for lots of averaging of random, noise-based signals
- It's difficult and time-consuming to correct the flatness of the multi-tone input stimulus
- The distortion floor in the notch may not be low enough, especially if a booster amplifier is used

The spectrum analysis application provides:

- Achieve fast and accurate NPR measurements with vector averaging of coherent, repetitive, multi-tone test waveforms
- Control external signal generators and AWGs to easily generate wideband modulated signals
- Quickly correct the power flatness of input signal
- Lower the distortion floor in the notches and adjacent channels with distortion-cancelling tones
- NPR measurement can be done as part of a single-connection-multiple-measurement setup with no cable changes

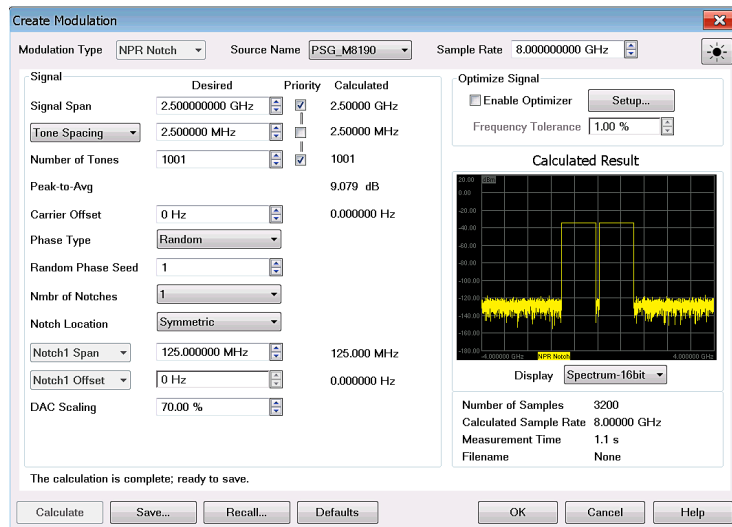

External signal generator wideband modulation signal creation on the PNA/PNA-L

Tips from the experts

- NPR is sometimes used to estimate the EVM of an amplifier, without the need for full demodulation
- NPR can also be used to evaluate high-linearity devices such as Analog-to-Digital Converters (ADC) by providing a test signal with a dense spectrum, and a clear notch from which the ADC distortion can be seen
- The new NPR signal calibration can support correcting the signal at the output of an amplifier for power and flatness, while correcting the signal at the input for low-notch distortion. This is a great way to support NPR measurements for exact power at the output while maintaining a pure signal at the input of an amplifier-under-test

PNA Series Innovative Applications

Fast and accurate noise figure measurements (S93029B)

Noise figure measurement challenges with traditional, Y-factor approach

- Multiple instruments and multiple connections required to fully characterize DUT
- Measurement accuracy degrades in fixtured, on-wafer, and automated-test environments, where noise source cannot be connected directly to DUT
- Measurements are slow, often leading to fewer measured data points and misleading results due to under-sampling

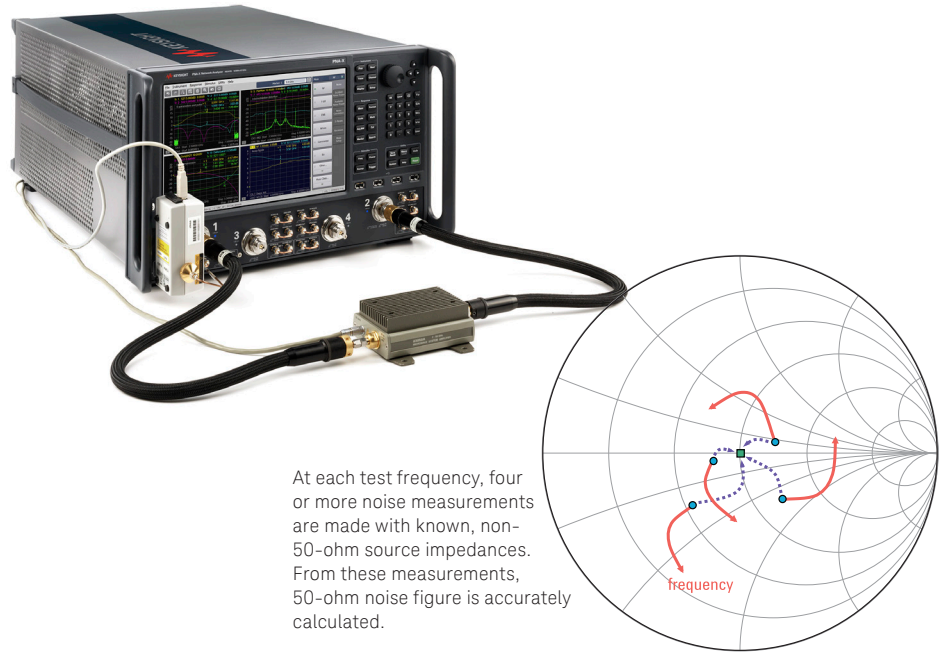

At each test frequency, four or more noise measurements are made with known, non-50-ohm source impedances. From these measurements, 50-ohm noise figure is accurately calculated.

PNA noise figure solution provides:

- Amplifier and frequency converter measurements with the highest accuracy in the industry, using advanced error-correction methods
- Correction for imperfect system source match by using vector correction to remove mismatch errors plus an ECal module used as an impedance tuner to remove noise-parameter-induced errors
- High measurement accuracy in fixtured, on-wafer, or automated-test environments
- Fast measurements: typically 4 to 10 times faster than Keysight's NFA Series noise figure analyzers
- Accurate measurements of differential devices using vector deembedding of baluns or hybrids

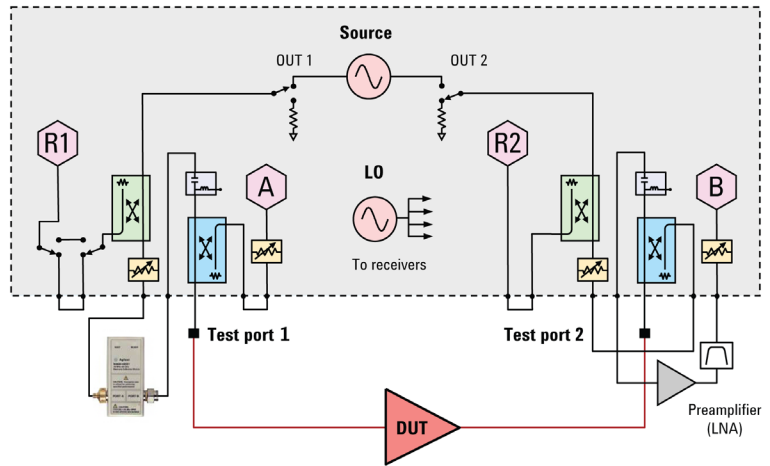

PNA noise figure measurement setup using an ECal module as an impedance tuner, and an external LNA and filter for improved sensitivity and measurement accuracy.

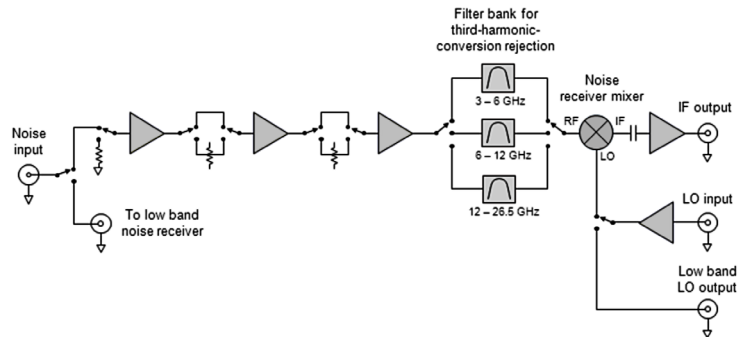

For wideband noise figure measurements, Keysight recommends a PNA-X with low-noise receiver Option 029, which includes built-in LNAs, harmonic-rejection filters, and for 44.5/50/67 GHz models, a built-in impedance tuner.

PNA Series Innovative Applications

Fast, high-gamma active-load amplifier characterization (S93088B)

Load-characterization measurement challenges

- Handling high-power DUTs
- Mechanical tuners cannot supply fully reflective loads and are slow

PNA source-phase control application provides:

- Fast active-loads using built-in second source or an external source
- Full reflection with user-defined fixed or swept phase angles
- Measurements of amplifier output power, match, and gain under different load conditions
- Hybrid setups that combine mechanical and active tuning for fundamental and harmonic load pull

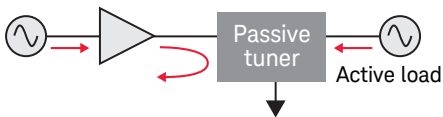

In a hybrid load-pull setup, the passive tuner provides the majority of the reflected signal, so the power required of the active load for full reflection is much lower.

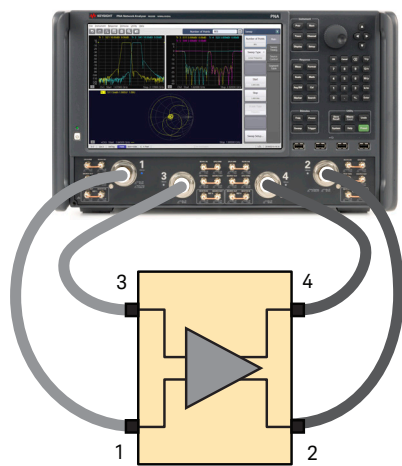

Using the PNA's two internal sources, iTMSA drives the differential amplifier under real world conditions, providing accurate mixed-mode S-parameters in all operating environments.

Simplified test of I/Q converters and modulators, and differential mixers (S93089B)

I/Q and differential converter measurement challenges

- Requires signals with 90° or 180° phase difference
- Traditional approach uses hybrid couplers and/or baluns which are:
 - Inherently band-limited, requiring multiple components for broadband measurements
 - Limited to fixed phase offsets, preventing phase sweeps to determine optimum alignment
 - Lossy and inaccurate ($\pm 3^\circ$ to 12° typically)
 - Difficult to use with on-wafer setups

PNA differential and I/Q devices application

- Provides accurate phase control of internal and external sources, eliminating the need for hybrid couplers and baluns
- Tunes receivers to all user-specified output frequencies needed to fully characterize the DUT
- Sweeps frequency to measure operating bandwidth or sweeps phase and power at a fixed frequency to measure quadrature or differential imbalance
- Includes match-corrected power measurements for highest accuracy

Testing differential amplifiers under real operating conditions (S93460B)

Differential amplifier measurement challenges

- Conventional two-port VNAs with baluns do not provide common-mode and mixed-mode responses
- Baluns are inherently band-limited devices, which forces multiple test setups for broad frequency coverage
- Phase errors of baluns provide inaccurate differential responses
- Modern four-port VNAs provide mixed-mode S-parameter measurements with single-ended stimulus, but differential amplifiers may respond differently when in compression during real operating environments

PNA integrated true-mode stimulus application (iTMSA) provides:

- Mixed-mode S-parameters of differential amplifiers driven by true differential and common-mode signals
- Mismatch correction at the DUT input to minimize phase and amplitude errors between the two sources
- Input-only drive mode that prevents damage to amplifiers caused by stimulus on the output port
- In-fixture arbitrary phase offset and phase-offset sweeps to optimize input matching network for maximum amplifier gain

PNA Series Innovative Applications

Accurate characterization of mixers and converters (S93082/83B)

Mixer and converter measurement challenges

- Traditional approach with spectrum analyzer and external signal sources is cumbersome, slow, and does not provide phase or group delay information
- Conventional VNAs require an external signal source, which degrades sweep speed
- Conventional VNAs provide phase or group delay data relative to a "golden" device
- Attenuators are often used to minimize ripple due to input and output mismatch, at the expense of dynamic range and calibration stability

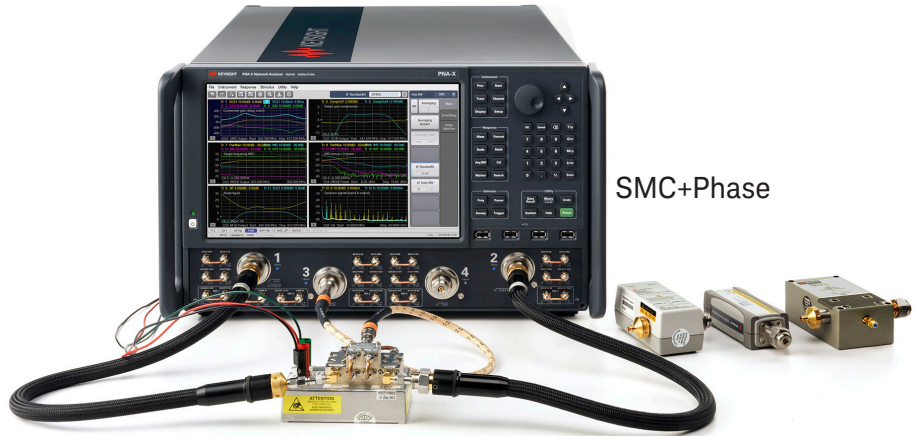

SMC+Phase

S93083B Scalar Mixer/Converter plus Phase (SMC+Phase) makes mixer and converter measurements simple to set up since reference and calibration mixers are not required. Calibration is easy to perform using three broadband standards: a power meter as a magnitude standard, a comb generator as a phase standard, and an S-parameter calibration kit (mechanical or ECal module).

PNA frequency converter applications provide:

- Simple setup using internal second signal source as a local oscillator (LO) signal
- Typical measurement time improvement of 100x compared to spectrum analyzer-based approach
- High measurement accuracy using two patented techniques:
 - Scalar mixer/converter (SMC) provides match and most accurate conversion loss/gain measurements by combining two-port and power-meter calibrations (S93082B), and with S93083B, calibrated absolute group delay measurements without a reference or calibration mixer
 - Vector mixer/converter (VMC) provides measurements of match, conversion loss/gain, delay, phase difference between multiple paths or devices, and phase shifts within a device, using a vector-calibrated through mixer (S93083B)
- Input and output mismatch correction reduces ripple and eliminates the need for attenuators

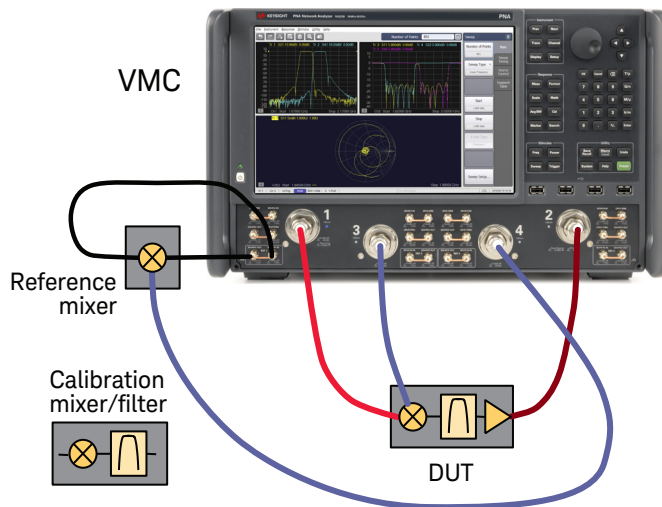

The vector mixer/converter technique provides measurements of match, conversion loss/gain, delay, phase difference between multiple paths or devices, and phase shifts within a device.

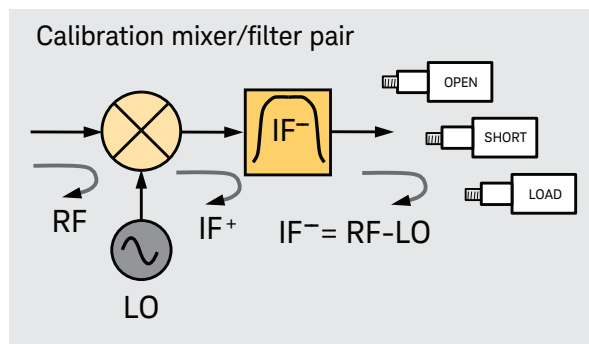

Keysight's frequency converter application vector-mixer- characterization method uses open, short, and load standards and reflection measurements to create a characterized, frequency-translating through standard.

PNA Series Innovative Applications

Measuring Converters with Embedded LOs (S93084B)

Embedded-LO application

- Uses coarse- and fine-tuning sweeps to calculate LO deviation from nominal value
- Automatically tunes the PNA receivers to correct for DUT LO drift, sweep by sweep
- Works with:
 - Noise figure application, S93029B
 - Scalar mixer/converter application, S93082B
 - Frequency converter application, S93083B
 - Gain compression application, S93086B
 - Intermodulation distortion application, S93087B

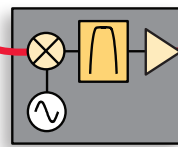
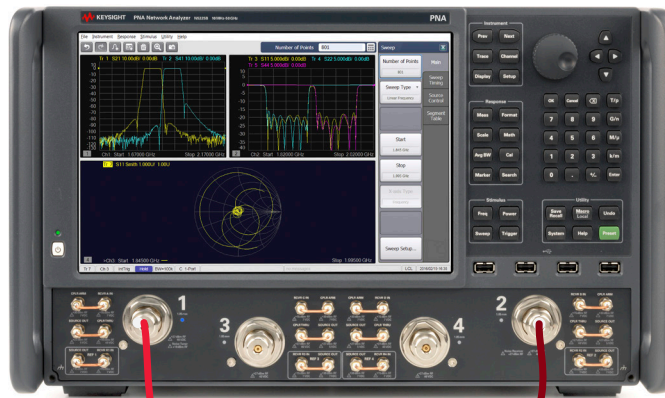

DUT

S93084B can be used in conjunction with many other PNA active-measurement applications to test converters with embedded LOs, without need for access to internal time bases.

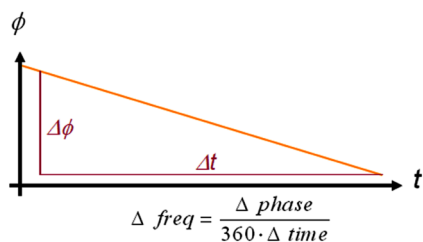
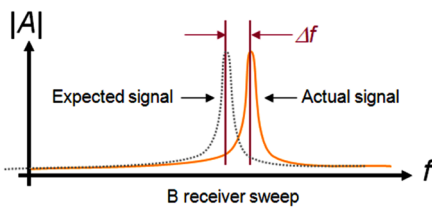

S93084A uses a coarse frequency sweep (top) to determine the nominal LO offset. A phase-versus-time sweep (bottom) is used to fine-tune the estimate of LO offset.

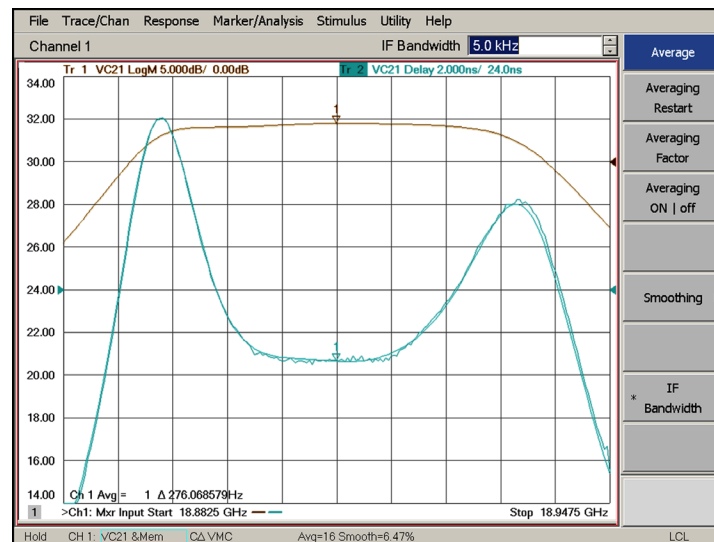

Comparing converter measurements with a locked and unlocked LO shows excellent measurement correlation. Averaging and modest amounts of smoothing are often used to increase accuracy and precision when measuring devices with embedded LOs.

PNA Series Innovative Applications

One-box solution for high-speed serial interconnect analysis (S93011B)

TDR measurement challenges

- As bit rates of digital systems increase, fast and accurate analysis of interconnect performance in both time and frequency domains is critical to ensure reliable system performance
- Managing multiple test solutions to completely characterize differential high-speed digital devices is difficult



PNA TDR application provides:

- One-box solution for high-speed interconnect analysis, including impedance, S-parameters, and eye diagrams

Simple and intuitive operation

- The user interface is designed to provide a similar look and feel to traditional TDR oscilloscopes

Fast and accurate measurements

- Accurate measurements due to unmatched performance of the PNA / PNA-L Series vector network analyzers
- State-of-the-art error correction techniques enables you to measure your device, not your measurement system

High ESD robustness

- Protection circuits implemented inside the instrument significantly increases ESD robustness, while at the same time maintaining excellent RF performance
- Highly robust architecture minimizes instrument failure from ESD and frees you from worrying about instrument repair fees and downtime

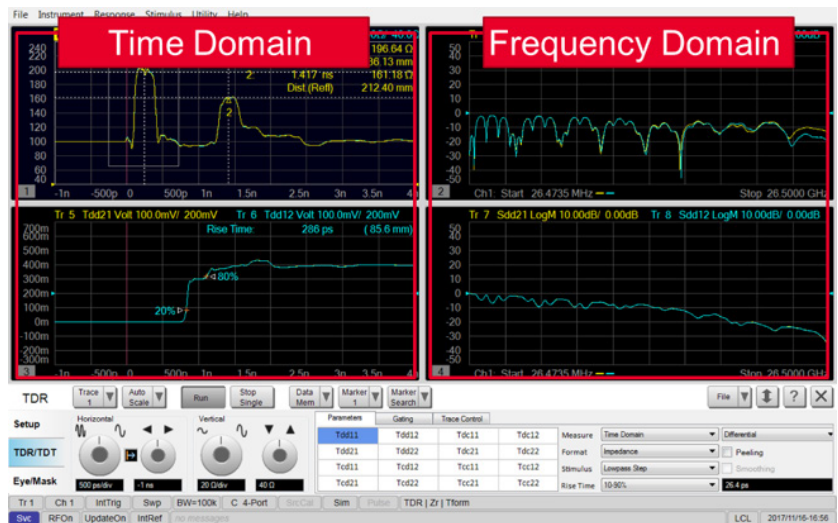

Measurements are taken as a function of frequency. The frequency domain information is used to calculate the Inverse Fourier Transform for time domain results.

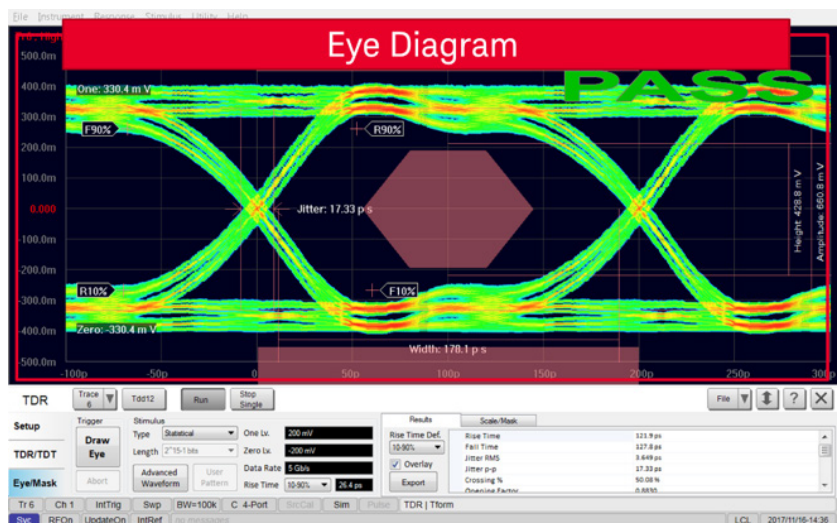

The simulated eye diagram analysis capability eliminates the need for a pulse pattern generator.

PNA Series Innovative Applications

Extending the PNA to millimeter-wave frequencies

PNA's unique hardware architecture provides:

- Single-sweep millimeter-wave network analyzer configurations with frequency coverage from 900 Hz to 120 GHz
- Two- and four-port solutions for measurements on a wide variety of single-ended and balanced millimeter-wave devices
- Differential and I/Q measurements at millimeter-wave frequencies using two, phase-controlled internal sources
- Fully integrated solution for millimeter-wave pulsed-RF measurements using built-in pulse modulators and pulse generators
- Accurate leveled power at millimeter-wave frequencies with advanced source-power calibration methods
- Two internal sources allow direct connection of THz frequency-extender modules

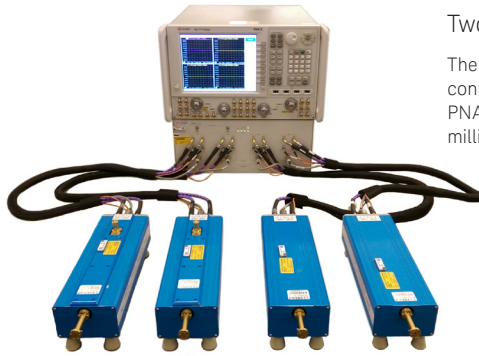

Two- and four-port banded solutions

The N5262A millimeter-wave test-set controller connects four millimeter-wave test modules to the PNA. For two-port measurements, the N5261A millimeter-wave test-set controller is available.



Two- and four-port broadband, single-sweep solutions (900 Hz to 120 GHz)

N5290/91A PNA-based 120 GHz millimeter-wave network analyzers are only available in two-port configurations. Four-port solutions are available using a four-port PNA-X network analyzer. N5290/91A broadband systems provide test capability to fully characterize passive, active, and frequency converting devices. These systems are compact replacements for N5251A systems, with superior performance and wider frequency range.

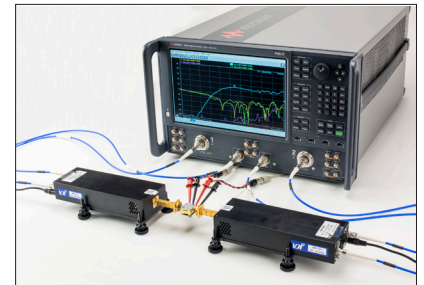

Terahertz solutions without a test set

Direct connection of VDI modules to a four-port PNA enables S-parameter measurements to 1.5 THz.

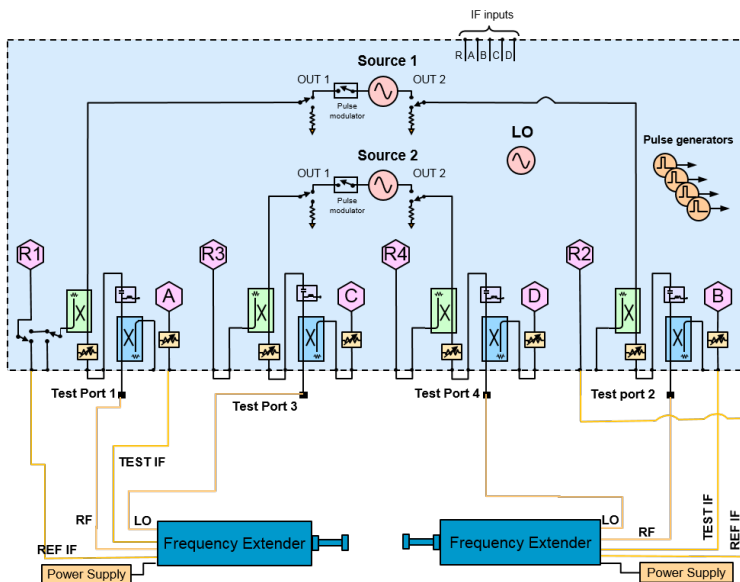

Two-port direct-connect system architecture

Block diagram of a two-port millimeter-wave system using a four-port PNA and two millimeter-wave frequency extenders.

PNA Series Innovative Applications

Millimeter-wave applications with the PNA

Millimeter-wave spectrum analysis

PNA-based millimeter-wave systems can take full advantage of spectrum analysis applications. This capability enables high-order harmonic and spur measurements at millimeter-wave frequencies.

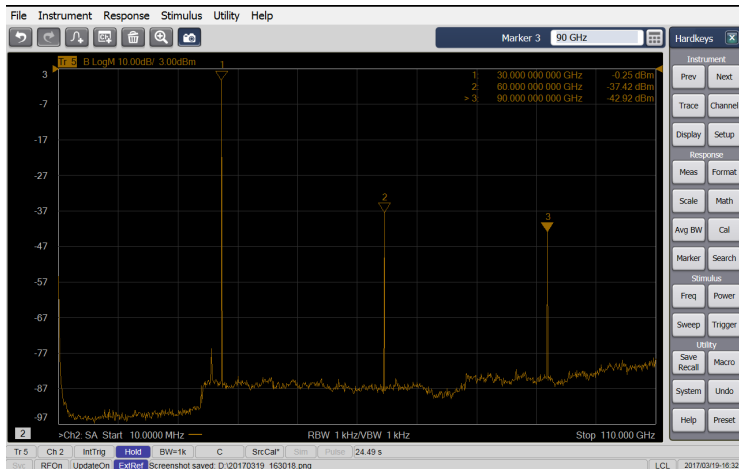

The PNA's spectrum analyzer application is used to measure the harmonics of a millimeter-wave amplifier.

Scalar mixer measurements

Measure conversion loss or gain plus input and output matches of mixers and frequency converters at millimeter-wave frequencies.

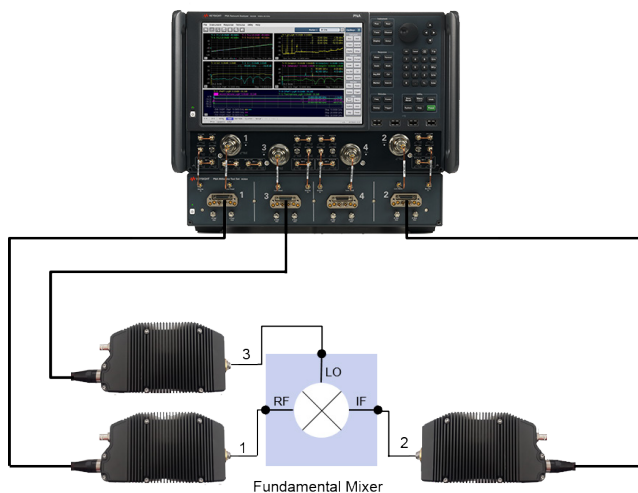

A dual-source PNA with an N5292A four-port controller and broadband frequency-extender modules characterize mixers and converters at millimeter wave frequencies. The PNA's second source can be used to provide an LO signal to a mixer.

Multi-channel measurements at millimeter-wave frequencies

Fully characterize active devices at millimeter-wave frequencies using multiple PNA software applications, with a single set of connections or wafer touch-downs. Calibration of multi-channel setups is easy using the Cal All Channels feature.



In addition to S-parameters, the spectrum analysis, gain compression, and differential I/Q applications are used to characterize a 10 MHz to 125 GHz amplifier.

Differential and I/Q measurements at millimeter-wave frequencies

- Highest measurement accuracy in the industry using advanced error-correction methods
- Integrated phase sweeps with power control

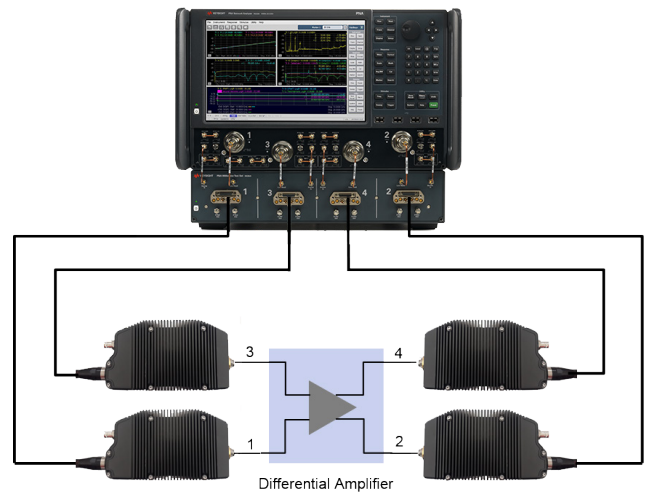

True-differential measurement of a balanced trans-impedance amplifier using a four-port PNA, the N5292A controller, and N5293A frequency extenders.

PNA-L: Passive and Active Device Test at Affordable Prices

The Keysight PNA-L is designed for your general-purpose network analysis needs and priced for your budget. With the same core firmware as the PNA, the PNA-L offers the perfect balance of value and performance. The PNA-L provides efficiency and flexibility in both manufacturing and R&D applications, for industries ranging from mobile-telecomm and wireless-LAN component production to aerospace and defense.

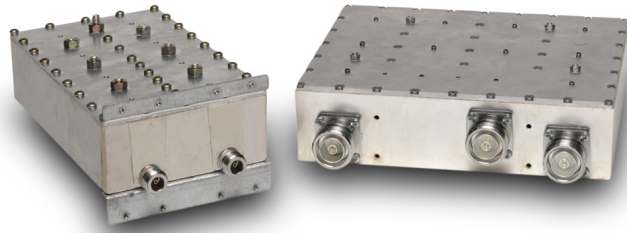

Balanced/differential components

For passive devices that have one or more balanced/differential ports, the PNA-L is an excellent choice for mixed-mode S-parameter measurements, without the need or limitations of using baluns.

- Display differential-, common-, and mixed-mode performance, in a variety of trace formats
- Measurement parameters include common-mode-rejection ratio and amplitude and phase imbalance
- Supported port configurations include single-ended-to-balanced and balanced-to-balanced topologies

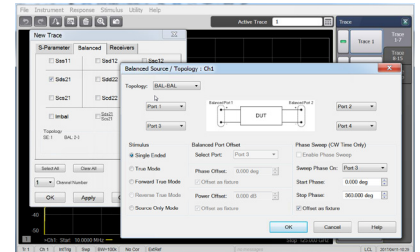
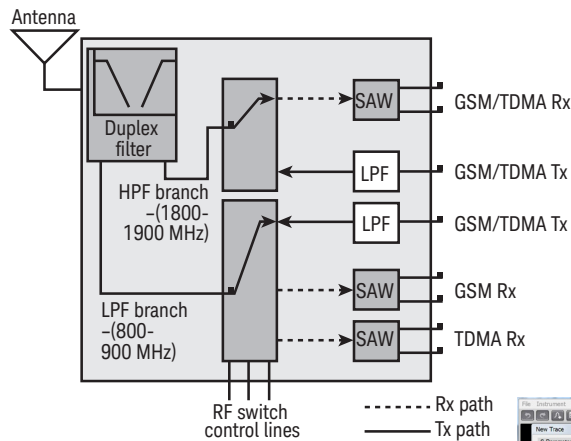

PNA-L Series Block Diagrams

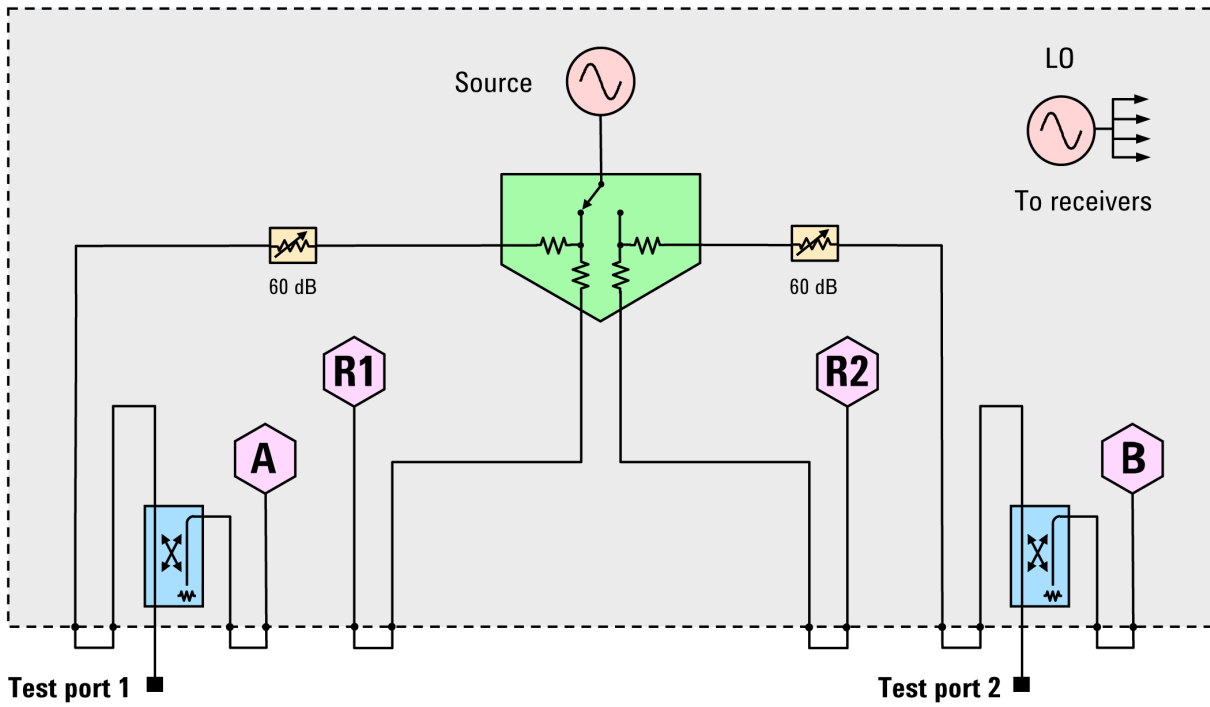

PNA-L Series 2-port block diagram shown with test set Option 216.

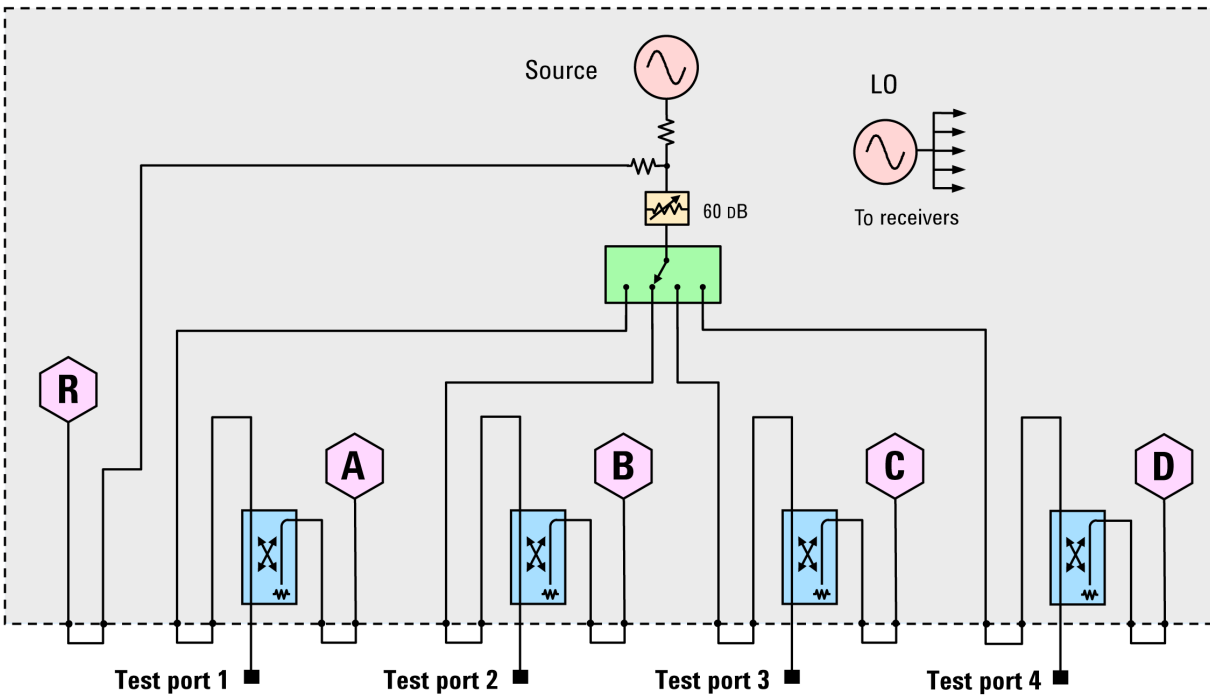

PNA-L Series 4-port block diagram shown with test set Option 416.

PNA-L Series: The Economical Choice for Signal Integrity and Material Measurements

Physical Layer Test Software (PLTS)

The Keysight PNA-L is the ideal microwave engine to power PLTS software.

PLTS provides:

- Forward and reverse reflection and transmission measurements, with time- and frequency-domain displays targeted specifically for signal-integrity analysis
- Guided setup, calibration, and data acquisition
- Full modal analysis including single-ended, differential, and cross-mode conversions
- A powerful, virtual bit-pattern generator to create eye diagrams based on measured channel data
- Highly accurate RLCG models to enhance the accuracy of your models and simulations
- Automatic fixture removal for symmetric and asymmetric fixtures
- Advanced formula editor for user-defined equations such as power sums for crosstalk-compliance measurements

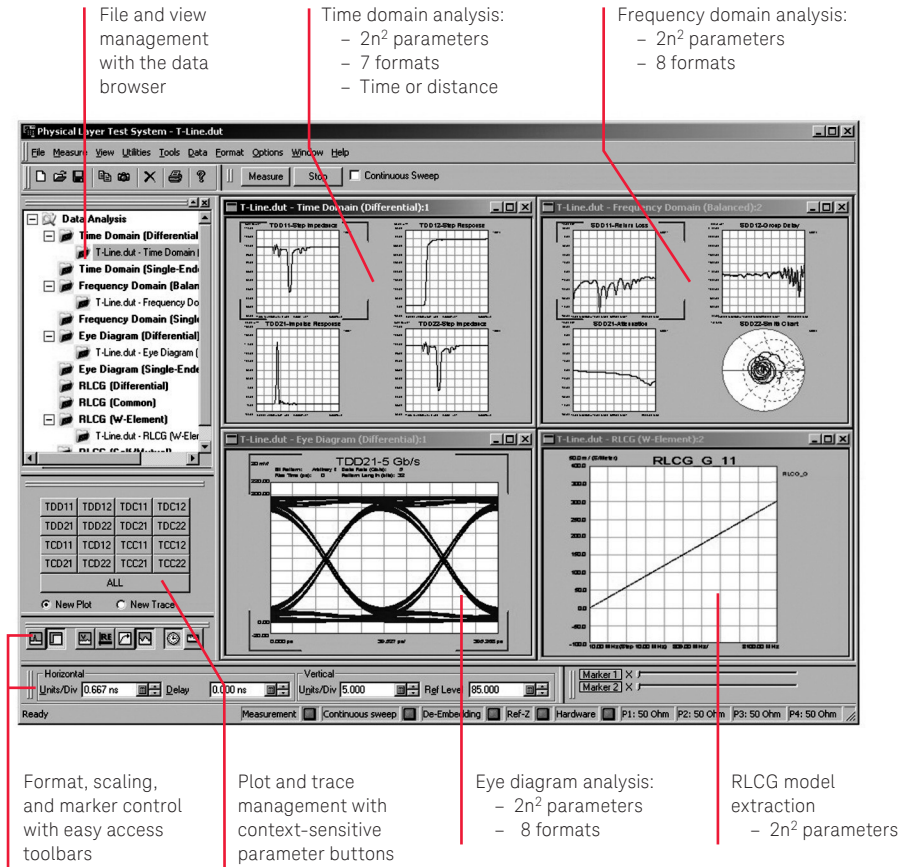

PLTS provides a wealth of analysis tools for signal-integrity engineers.

Materials measurements

Keysight offers several tools to help determine the intrinsic electromagnetic properties of materials, including N1500A materials measurement software, N1501A dielectric probe kit, 16451B/2A/3A/4A Material Test Fixture, N1501AExx Split Post Dielectric Resonator, and 85072A split cylinder resonator. The complete system is based on a versatile Keysight network analyzer like the PNA-L, LCR meters, and impedance analyzers, which measures the material's response to DC, RF or microwave energy.

Keysight material measurements solutions provide:

- Control of the network analyzer to automate complex permittivity and permeability measurements versus frequency
- Display of results in a variety of formats (ϵ_r' , ϵ_r'' , $\tan \delta$, μ_r' , μ_r'' , $\tan \delta_m$ and Cole-Cole)
- A variety of measurement methods and mathematical models to meet most application needs
- Support for many different probes and fixtures, as well as free-space measurements
- Data easily shared with other Windows-based programs or through the component object model (COM) interface

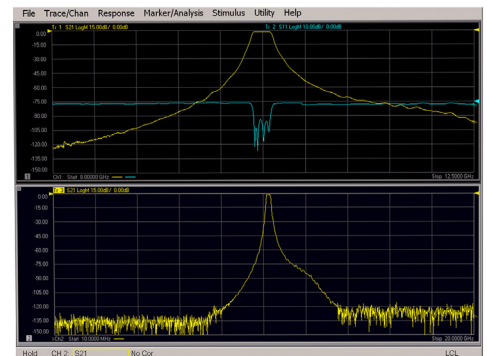

On-Wafer Measurements with the PNA Family

PNA and PNA-L network analyzers can easily be integrated with a microwave probe station to form a complete on-wafer measurement system. All of the PNA's powerful measurement applications can be used for on-wafer devices. When calibration requires a power sensor, the PNA firmware guides the user through the steps required to align power and S-parameter calibration planes into a single set of on-wafer reference planes.

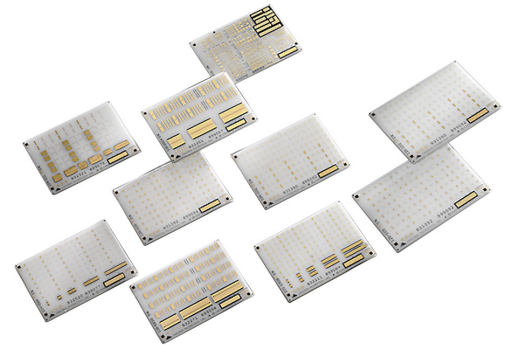

PNA-based on-wafer solutions provide:

- Measurements on filters, amplifiers, and frequency converters
- Complete set of TRL-class calibrations for accurate measurements
- Differential measurement capability using single-ended or true-mode stimulus
- Accurate power-level control for precise power measurements
- Probe-characterization macro to easily measure S-parameters of probes for deembedding

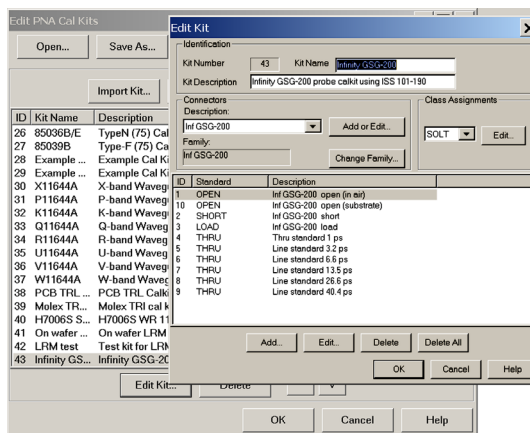

The PNA cal kit editor makes it easy to enter impedance-substrate standard (ISS) definitions for on-wafer calibration

Complete wafer-probe solutions from Cascade Microtech

Cascade Microtech is the worldwide leader for high-quality microwave probing systems and is an official Keysight Solutions Partner. Cascade offers a broad variety of test stations and probes to cover any application and frequency range. In addition, WinCal XE software enhances RF measurement accuracy and productivity through guided system setup, automatic calibration and validation, test sequencing, and other advanced RF measurement tools.

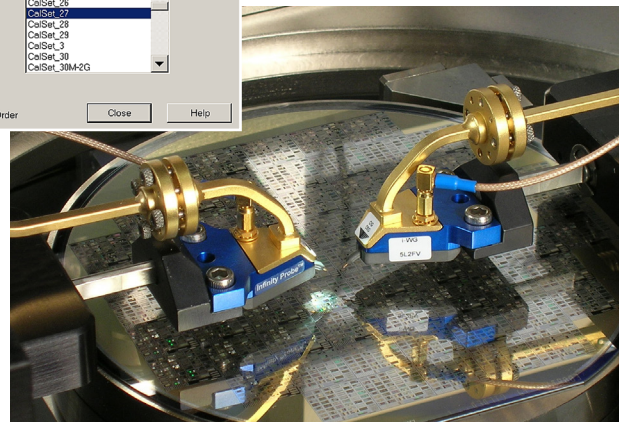
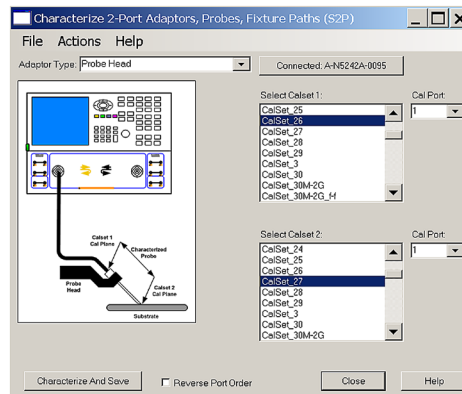

Extend the Power of the PNA Family to Multiport Devices

Multiport test challenges:

- Many components have more than 4 ports
- Moving test cables is slow and prone to errors
- Standard two-port calibration doesn't correct for ports outside the test path, resulting in degraded accuracy

PNA and PNA-L multiport solutions provide:

- Integrated test systems consisting of a network analyzer and an external multiport test set, seamlessly controlled by the PNA's firmware
- A single set of test connections to the DUT, resulting in high test throughput
- High accuracy with advanced calibration methods.
- Full compatibility with PLTS

Flexible test set hardware

- Test couplers on each port provide accurate and stable measurements
- External signal conditioning hardware such as attenuators, amplifiers, or isolators can be added as needed to handle a variety of device types
- Get full cross-bar switching to cover any DUT, or limit the test paths to match those required by a specific DUT

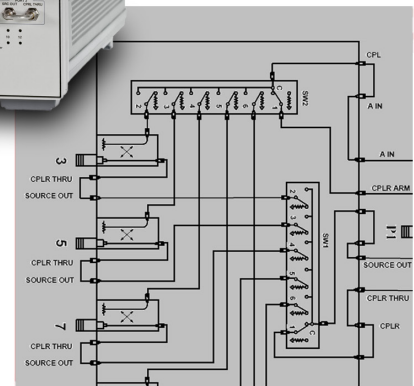

Advanced calibration

- N-port calibration corrects the load match at all ports of the DUT, whether they are in the test path or not. This gives a high level of accuracy, independent of the isolation between ports of the DUT.
- QSOLT (quick short, open, load, thru) calibration reduces the number of correction standards required for full N-port calibration
- Application-specific calibrations to support compression, IMD, and noise figure can be applied in conjunction with the test set

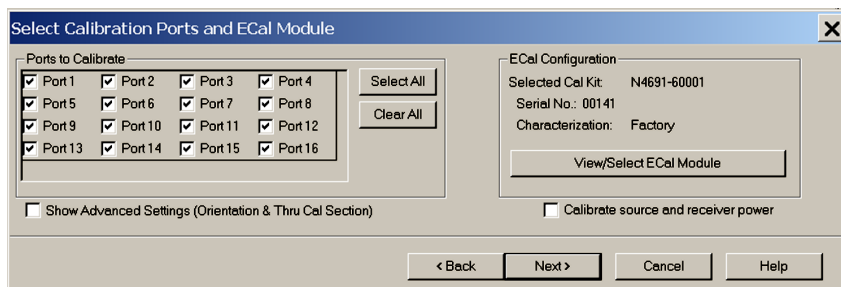

Completing the Solution

Advanced calibration tools

Calibrating network analyzers is critical for high accuracy measurements and can be particularly challenging in non-coaxial environments such as in-fixture, on-wafer, or waveguide. The PNA family supports a broad range of mechanical and electronic calibration kits, and offers advanced calibration methods to enhance ease-of-use while providing best-in-class accuracy. Keysight calibration tools include:

- High-performance two-and four-port ECal modules, covering 300 kHz to 67 GHz, with nine connector types
- QSOLT and n-port calibration for multiport test systems
- Data-based calibration-standard models and expanded math for enhanced accuracy at high frequencies
- Match-corrected power measurements to eliminate mismatch errors
- Software fixturing for deembedding, port matching, and impedance transformation

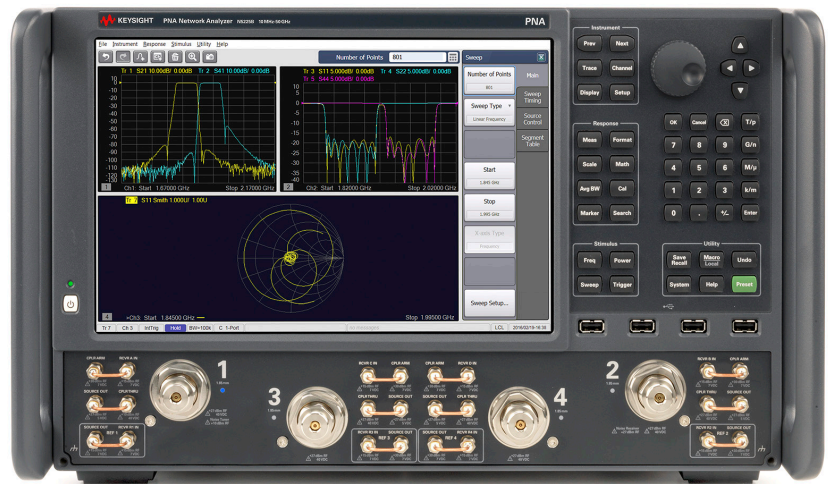

Protect your software investment

Keysight protects your 8753, 8720 and 8510 software investment by providing migration tools to reduce your code conversion effort.

www.keysight.com/find/nadisco

Network analyzer forum

Visit the online network analyzer discussion forum where you can learn how your peers are solving some of their most challenging measurement problems.

www.keysight.com/find/na_forum

Application notes

More information about PNA network analyzer applications can be found at

www.keysight.com/find/pnaapps

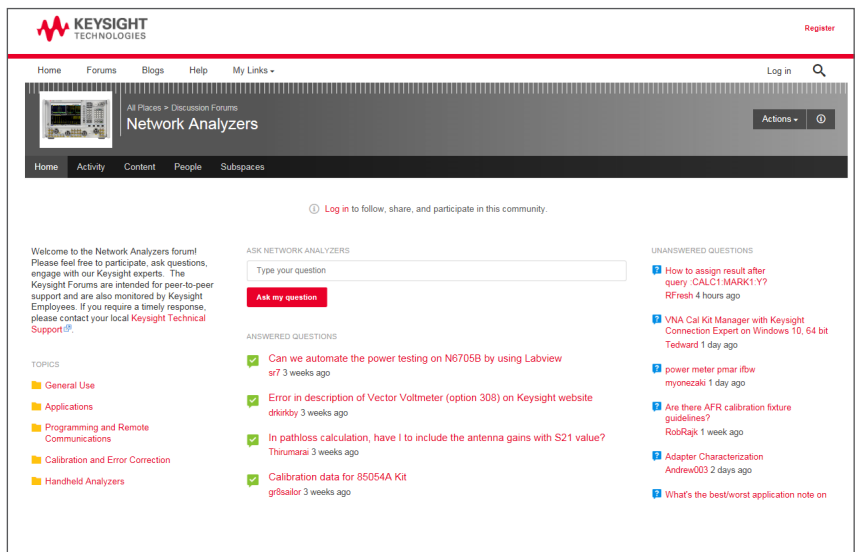

Keysight Software Licensing Options Provide Flexibility and Support

Projects ramp up and down, teams grow and shrink, and projects move location. In such a dynamic environment, you need flexible licensing options that allow you to balance your project's requirements. Whether your software will be a staple for years to come or you have a short-term need for a leading-edge measurement application, Keysight's licensing puts you in charge.

Choose your term. Choose your type. Keep control of your budget.

- Select a node-locked, transportable, USB portable or floating license type, depending on how much flexibility you need.
- Select a time-based or perpetual license term, depending on how long you need to use the software.
- Each license is sold with a KeysightCare software support subscription which provides technical support with ensured response time, proactive software updates, enhancements and fixes.

Choose a license term and type that best suits your requirements from the table below.

Table 1. License term

License Term	Options
Perpetual	Perpetual licenses can be used indefinitely.
Time-based	Time-based licenses can be used through the term of the license (6, 12, 24, or 36 months).

Table 2. License type

License Type	Descriptions
Node locked	License can be used on one specified instrument/computer.
Transportable	License can be used on one instrument/computer at a time but may be transferred to another using Keysight Software Manager (internet connection required).
USB portable	License can be used on one instrument/computer at a time but can be transferred to another using a certified USB dongle (available for additional purchase, Keysight part number E8900-D10).
Floating	Networked instruments/computers can access a license from a server one at a time. Multiple licenses may be purchased for concurrent usage. Three types of floating license are available: Single Site: 1-mile radius from the server Single Region ¹ : Americas, Europe, Asia Worldwide (export restriction identified in End User License Agreement (EULA))

1. Americas (North, Central, and South America, Canada); Europe (European Continent, Middle Eastern Europe, Africa, India); Asia (North and South Asia Pacific Countries, China, Taiwan, Japan)

KeysightCare Software Support Subscription provides peace of mind amid evolving technologies.

- Ensure your software is always current with the latest enhancements and measurement standards.
- Gain additional insight into your measurement problems with live access to our team of technical experts.
- Stay on schedule with fast turnaround times and priority escalations when you need support.

Table 3. KeysightCare software support subscription

Subscription	Descriptions
KeysightCare software support subscription	Perpetual licenses are sold with a 12 (default), 24, 36, or 60-month software support subscription. Support subscriptions may be renewed for a fee after that. Time-based licenses include a software support subscription through the term of the license.

Ordering Information

- Step 1. Choose your software product.
- Step 2. Choose your license term: perpetual or time based.
- Step 3. Choose your license type: node-locked, transportable, USB portable, or floating.
- Step 4. Depending on the license term, choose your support subscription duration.

Product	License Type	License Term			
		License	Perpetual	Support subscription	Time-based
S93xxxB/S94xxxB	Node-locked (fixed)	R-A5A-001-A	+	R-A6A-001-z	R-A4A-001-z
	Transportable	R-A5A-004-D	+	R-A6A-004-z	R-A4A-004-z
	USB Portable ¹	R-A5A-005-E	+	R-A6A-005-z	R-A4A-005-z
	Floating (single site)	R-A5A-002-B	+	R-A6A-002-z	R-A4A-002-z
	Floating (single region)	R-A5A-006-F	+	R-A6A-006-z	R-A4A-006-z
	Floating (worldwide)	R-A5A-010-J	+	R-A6A-010-z	R-A4A-010-z
				z = subscription duration	z = subscription duration
				L 12 months (default) ²	F 6 months
				X 24 months	L 12 months
				Y 36 months	X 24 months
				Z 60 months	Y 36 months

1. USB portable license requires a certified USB dongle (available for additional purchase, Keysight part number E8900-D10)
2. For S93xxxB software, the fixed-perpetual with a 12-months, support subscription (R-A6A-001-L) is the only license type that can be ordered as part of the instrument and installed. The other license types for S93xxxBs and all license types for S94601B/2B must be ordered separately and installed from the web after the receipt of the instrument.

Additional resources can be found at:

www.keysight.com/find/accessories
www.keysight.com/find/antenna
www.keysight.com/find/ecal
www.keysight.com/find/materials
www.keysight.com/find/multiport
www.keysight.com/find/plts
www.keysight.com/find/pna
www.keysight.com/find/pulsedrf
www.keysight.com/find/pna

Learn more at: www.keysight.com

For more information on Keysight Technologies' products, applications or services, please contact your local Keysight office. The complete list is available at:

www.keysight.com/find/contactus

