



rf/microwave instrumentation

Operating and Service Manual

1200A225

Model

10044017

Part Number

Serial Number



Declaration of Conformity

Issue Date: October 2020
Model #/s: Model 1200A225 Series
Type of Equipment: RF Broadband Amplifier
Function: Designed to be used in a RF immunity test system or for research. The unit is intended to amplify an RF signal and inject it into a load.

The equipment described above is declared to be in conformity with the following applicable national and international standards. The conformity is valid only when equipment is used in a manner consistent with the manufacturer’s recommendations and the reference documents.

EMC:
DIRECTIVE 2014/30/EU of the European Parliament and of the Council of 26 February 2014 on the harmonisation of the laws of the Member States relating to electromagnetic compatibility
EN 61326-1:2013 Electrical equipment for measurement, control and laboratory use–EMC requirements–Part 1: General Requirements
SAFETY:
DIRECTIVE 2014/35/EU of the European Parliament and of the Council of 26 February 2014 on the harmonisation of the laws of the Member States relating to the making available on the market of electrical equipment designed for use within certain voltage limits
CENELEC EN 61010-1 Issued 2010/10/01 Ed: 3 Safety Requirements for Electrical Equipment for Measurement Control and Laboratory Use – Part 1: General Requirements
UL 61010-1 Issued 2012/05/11 Ed: 3 Safety Requirements for Electrical Equipment for Measurement Control and Laboratory Use – Part 1: General Requirements
CAN/CSA C22.2 #61010-1 Issued 2012/05/11 Ed: 3 Safety Requirements for Electrical Equipment for Measurement Control and Laboratory Use – Part 1: General Requirements
HAZARDOUS SUBSTANCES (RoHS):
DIRECTIVE 2011/65/EU of the European Parliament and of the Council of 8 June 2011 on the restriction of the use of certain hazardous substances in electrical and electronic equipment (recast) Commission Delegated Directive (EU) 2015/863 of 31 March 2015 amending Annex II to Directive 2011/65/EU of the European Parliament and of the Council as regards the list of restricted substances
Directive (EU) 2017/2102 of the European Parliament and of the Council of 15 November 2017 amending Directive 2011/65/EU on the restriction of the use of certain hazardous substances in electrical and electronic equipment
RECYCLING (WEEE):
DIRECTIVE 2012/19/EU of the European Parliament and of the Council of 4 July 2012 on waste electrical and electronic equipment (WEEE) (recast)
SUBSTANCES OF VERY HIGH CONCERN (REACH):
REGULATION (EC) 1907/2006 of the European Parliament and of the Council of 18 December 2006 concerning the Registration, Evaluation, Authorization and Restriction of Substances of Very High Concern Chemicals (SVHC)

Supporting documentation is held by AR RF/Microwave Instrumentation’s Quality department in Pennsylvania, United States.

Place of issue: AR RF/Microwave Instrumentation
160 Schoolhouse Road
Souderton, Pennsylvania 18964 USA

Authorized officer of the company:

Patricia Thrasher
Manager Quality & Service

Instructions for European EMC Conformity



It is the responsibility of the user of this equipment to provide electromagnetic shielding, filtering and isolation which is necessary for EMC compliance to Directive 2014/30/EU. The equipment must therefore be operated in a shielded area which provides a sufficient level of attenuation to meet the radiated emissions and immunity specifications. The following minimum levels are suggested for use in accordance with the rated power of the equipment.

Rated Power	Minimum shielding attenuation
100 watts	50 dB
101 - 1000 watts	60 dB
1001 - 10,000 watts	70 dB

Since this equipment is designed to generate high levels of Radio Frequency energy, it is also essential that the user read and follow the “Instructions for Safe Operation” in this manual. If other equipment is operated in the shielded room it may be disturbed by the amplifier.



Der Benutzer dieses Gerätes ist dafür verantwortlich, daß die elektromagnetische Abschirmung und Filterung gewährleistet ist, welche gemäß Richtlinie 2014/30/EU notwendig ist. Das Gerät muß deshalb in einem geschirmten Raum betrieben werden, welcher eine ausreichenden Schirmung bietet, um die Emissions- und Störfestigkeitsspezifikation einzuhalten. Es werden folgenden Minimalwerte der Schirmdämpfung und Filterung in den unterschiedlichen Leistungsklassen empfohlen.

Hochfrequenzleistung	min. Schirmdämpfung
100 Watt	50 dB
101-1000 Watt	60 dB
1001-10.000 Watt	70 dB

Falls andere elektrische oder elektronische Geräte gleichzeitig mit dem Gerät betrieben werden, kann es zu Beeinflussungen kommen. Da das Gerät zur Erzeugung von Hochfrequenzenergie dient ist es daher auch unbedingt notwendig, daß der Benutzer die Sicherheitsvorschriften in der Bedienungsanleitung liest und einhält.



Il est de la responsabilité de l'utilisateur de cet équipement d'assurer la protection électromagnétique, le filtrage et l'isolation nécessaires, afin de se conformer à la directive 2014/30/EU concernant la C.E.M. Par conséquent, cet équipement doit être mis en fonctionnement dans une enceinte d'atténuation suffisante pour satisfaire aux spécifications d'émissivité et de susceptibilité. Pour une utilisation conforme, les niveaux d'atténuation minimums suivants sont suggérés en fonction de la puissance de sortie de l'équipement:

Puissance de sortie	Atténuation minimum de l'enceinte
100 Watts	50 dB
101 à 1.000 Watts	60 dB
1.001 à 10.000 Watts	70 dB

Puisque cet équipement est destiné à générer de forts niveaux R.F., il est essentiel que l'utilisateur se conforme aux instructions de sécurité indiquées dans ce manuel. Tout autre équipement en fonctionnement dans la cage de Faraday peut-être perturbé par l'amplificateur.

INSTRUCTIONS FOR SAFE OPERATION









Observe the following safety guidelines to help ensure your own personal safety and to help protect your equipment and working environment from potential damage.

INTENDED USE

This equipment is intended for general laboratory use in generating, controlling, and measuring levels of electromagnetic Radio Frequency (RF) energy. Ensure that the device is operated in a location which will control the radiated energy and will not cause injury or violate regulatory levels of electromagnetic interference.

SAFETY SYMBOLS

These symbols may appear in your user manual or on equipment.

	This symbol is marked on the equipment when it is necessary for the user to refer to the manual for important safety information. The caution symbol denotes a potential hazard. Attention must be given to the statement to prevent damage, destruction, or harm.
	Dangerous voltages are present. Use extreme care.
	Indicates a terminal intended for connection to an external conductor for protection against electrical shock in case of a fault, or the terminal of a protective earth (ground) electrode.
	Indicates invisible laser radiation—do not view directly with optical instruments.
	Indicates frame or chassis ground connection terminal.
	Indicates alternating current.
	Indicates this product must not be disposed of with your other household waste.
	Indicates that the marked surface and adjacent surfaces can attain temperatures that may be hot to the touch.

EQUIPMENT SETUP PRECAUTIONS



Review the user manual and become familiar with all safety markings and instructions. Protection provided by the equipment may be impaired if used in a manner not specified by AR RF/Microwave Instrumentation (AR).

- Follow all lifting instructions specified in this document.
- Place the equipment on a hard, level surface.
- Do not use the equipment in a wet environment, for example, near a sink, or in a wet basement.
- Position your equipment so that the power switch is easily accessible.
- Leave 10.2 cm (4 in) minimum of clearance on all vented sides of the equipment to permit the airflow required for proper ventilation. Do not restrict airflow into the equipment by blocking

any vents or air intakes. Restricting airflow can result in damage to the equipment, intermittent shut-downs or safety hazards.

- Keep equipment away from extremely hot or cold temperatures to ensure that it is used within the specified operating range.
- While installing accessories such as antennas, directional couplers and field probes, take care to avoid any exposure to hazardous RF levels.
- Ensure that nothing rests on your equipment's cables and that the cables are not located where they can be stepped on or tripped over.
- Move equipment with care; ensure that all casters and/or cables are firmly connected to the system. Avoid sudden stops and uneven surfaces.

BEFORE APPLYING POWER

Your AR equipment may have more than one power supply cable. Use only approved power cable(s). If you have not been provided with a power cable for the equipment or for any AC-powered option intended for the equipment, purchase a power cable that is approved for use in your country. The power cable must be rated for the equipment and for the voltage and current marked on the equipment's electrical ratings label.



Incorrectly installing or using an incompatible line voltage may increase the risk of fire or other hazards. To help prevent electric shock, plug the equipment and peripheral power cables into properly grounded electrical outlets. These cables are equipped with three-prong plugs to help ensure proper grounding. Do not use adapter plugs or remove the grounding prong from a cable.

Do not modify power cables or plugs. Consult a licensed electrician or AR trained service technician for equipment modifications. Always follow your local/national wiring rules.



Do not operate the equipment if there is physical damage, missing hardware, or missing panels.

SAFETY GROUND



This equipment is provided with a protective earth terminal. The mains power source to the equipment must supply an uninterrupted safety ground of sufficient size to attach wiring terminals, power cord, or supplied power cord set. ***DO NOT USE this equipment if this protection is impaired.***

INSTRUCTIONS FOR SAFE OPERATION

HAZARDOUS RF VOLTAGES



The RF voltages on the center pin of an RF output connector can be hazardous. The RF output connector should be connected to a load before AC power is applied to the equipment. Do not come into contact with the center pin of the RF output connector or accessories connected to it. Place the equipment in a non-operating condition before disconnecting or connecting the load to the RF output connector.

ACOUSTIC LIMITATIONS

If equipment noise exceeds 80dB, ear protection is required.

MAINTENANCE CAUTION

Adjustment, maintenance, or repair of the equipment must be performed only by qualified personnel. Hazardous energy may be present while protective covers are removed from the equipment even if disconnected from the power source. Contact may result in personal injury. Replacement fuses are required to be of specific type and current rating.

ENVIRONMENTAL CONDITIONS

Unless otherwise stated on the product specification sheet, this equipment is designed to be safe under the following environmental conditions:

- Indoor use
- Altitude up to 2000m
- Temperature of 5°C to 40°C
- Maximum relative humidity 80% for temperatures up to 31°C. Decreasing linearly to 50% at 40°C.
- Main supply voltage fluctuations not to exceed $\pm 10\%$ of the nominal voltage or minimum and maximum autoranging values.
- Pollution degree 2: Normally non-conductive with occasional condensation. While the equipment will not cause hazardous condition over this environmental range, its performance may vary.

EQUIPMENT CONTAINING LASERS



AR Field Probes (FL/PL Series) and Field Analyzers (FA Series) are Class 1 laser products containing embedded Class 4 lasers. Under normal use, the laser radiation is completely contained within the fiber optic cables and poses no threat of exposure. Safety interlocks ensure that the laser is not activated unless the cables are properly connected. Always exercise caution when using or maintaining laser products. Do not view directly with optical instruments.

RF ANTENNAS

- This equipment (antenna or antenna assembly) may be heavy, requiring two persons to lift. Use caution when installing or removing unit. Follow all equipment setup and lifting instructions specified in this document.
- Ensure connectors are appropriate for intended operation. Connectors are specified in the user manual and product specification sheet.
- Do not exceed the maximum RF input level stated in the specifications. Refer to the user manual and product specification sheet to determine the applicable RF levels.
- Excessive RF input could damage the equipment or connectors, causing safety hazards.
- When in operation, the RF voltages on the antenna elements can be hazardous. Do not come into contact with the antenna or elements when the RF input connector is connected to a live RF source.
- To avoid injury to personnel and accidental damage to power amplifier or antenna, disable the RF output of power amplifier before connecting or disconnecting the input connection to the antenna.
- Perform periodic inspections of antenna and field probe systems to verify calibration due date, proper operation, and overall condition of equipment.

RACK MOUNTED TWT MODELS

Some TWT models are supplied without the removable enclosure offered for benchtop use. These rack-mountable models may be supplied with either carry handles or slides and front handles installed. Follow all lifting instructions specified in this document and installation instructions supplied in the TWT user manual.

LIFTING INSTRUCTIONS FOR AR EQUIPMENT

Because most products must be handled during distribution, assembly and use, the risk of serious injury due to unsafe product handling should be a fundamental consideration of every user. An authoritative guideline for eliminating unwarranted risk of injury caused by lifting is provided by the NIOSH Work Practices (Publication #94-110) available at:



<https://www.cdc.gov/niosh/docs/94-110/pdfs/94-110.pdf>.

In general, observe the following guidelines for lifting a weight of 50 lb or more:

- Use lifting eye (for floor standing) or side handles (table top) to lift unit only.
- Use equipment of adequate capacity to lift and support unit.
- If using forklift to move unit, be sure forks are long enough to extend beyond the side of the unit.
- For additional information, follow the link specified above.

HINWEISE FÜR DEN SICHEREN GEBRAUCH









Bitte beachten Sie die folgenden Hinweise zum Schutz Ihrer persönlichen Sicherheit und um Ihre Ausrüstung und Ihren Arbeitsplatz vor möglichen Schäden zu bewahren.

VORGESEHENE VERWENDUNG

Dieses Gerät ist für den allgemeinen Einsatz im Labor bestimmt. Es dient der Erzeugung, Steuerung und Messung von elektromagnetischer Hochfrequenzenergie (RF). Stellen Sie sicher, dass das Gerät an einem Ort in Betrieb genommen wird, an dem die abgestrahlte Energie gesteuert werden kann, so dass niemand Schaden erfährt und elektromagnetische Störungen vermieden werden.

SICHERHEITSSYMBOL

Einige dieser Symbole befinden sich sowohl in der Bedienungsanleitung als auch auf dem Gerät selbst.

	Dieses Symbol befindet sich auf dem Gerät und weist darauf hin, dass der Nutzer an dieser Stelle wichtige Sicherheitsinformationen in der Bedienungsanleitung studieren soll. Das Warnsymbol weist auf eine mögliche Gefahr hin. Zur Vermeidung von Personen- oder Sachschäden gilt es, die Hinweise zu beachten.
	Gefährliche elektrische Spannungen sind vorhanden. Höchste Vorsicht ist geboten.
	Weist darauf hin, dass an dieser Stelle eine Klemme für den Anschluss an einen Außenleiter anzubringen ist, zum Schutz vor einem Stromschlag oder im Fall einer auftretenden Störung, oder dass eine Klemme anzubringen ist, die als schützende Erdungselektrode fungiert.
	Zeigt unsichtbare Laserstrahlung an – nicht direkt hineinschauen.
	Weist auf eine Rahmen- oder Chassis-Anschlussklemme hin.
	Zeigt Wechselstrom an.
	Weist darauf hin, dass dieses Produkt nicht mit Ihrem restlichen Hausmüll entsorgt werden darf.
	Weist darauf hin, dass die markierte Oberfläche und benachbarte Flächen extrem heiße Temperaturen erreichen können und daher nicht angefasst werden sollten.

SICHERHEITSHINWEISE FÜR DEN AUFBAU DES GERÄTS



Lesen Sie die Bedienungsanleitung aufmerksam durch und machen Sie sich mit allen Sicherheitsmarkierungen und Anweisungen vertraut. Die Sicherheit kann beeinträchtigt sein, falls das Gerät in einer anderen Weise verwendet wird, als von der AR RF/Microwave Instrumentation (AR) vorgegeben ist.

- Zum Heben und Transport folgen Sie allen in dieser Anleitung angegebenen Anweisungen.
- Platzieren Sie das Gerät auf einer harten, ebenen Oberfläche.
- Verwenden Sie das Gerät nicht in feuchter Umgebung, zum Beispiel in der Nähe einer Spüle oder in einem feuchten Keller.
- Platzieren Sie Ihr Gerät so, dass der Netzschalter leicht zugänglich ist.

- Halten Sie einen Mindestabstand von 10,2 cm (4 in) auf allen belüfteten Seiten des Geräts ein, um eine ausreichende Luftzirkulation zu gewährleisten. Beeinträchtigen Sie den Luftstrom des Geräts nicht, indem Sie Lüftungsöffnungen oder den Lufteinlass blockieren. Wird der Luftstrom eingeschränkt, kann dies zu Schäden am Gerät, periodischen Abschaltungen und anderen Gefahren führen.
- Halten Sie das Gerät von extrem heißen oder kalten Temperaturen fern, um sicherzustellen, dass es nur in dem vorgeschriebenen Bedienungsbereich verwendet wird.
- Achten Sie beim Installieren von Zubehör wie Antennen, Richtungskupplungen und Feldsonden darauf, dass sie keinen gefährlichen HF-Werten ausgesetzt sind.
- Stellen Sie sicher, dass nichts auf den Kabeln Ihres Geräts steht. Bringen Sie die Kabel so an, dass niemand darauf treten oder darüber stolpern kann.
- Seien Sie vorsichtig, wenn Sie das Gerät bewegen. Achten Sie darauf, dass alle Rollen und/oder Kabel fest mit dem System verbunden sind. Vermeiden Sie plötzliche Stopps und Oberflächen, die nicht eben sind.

BEVOR SIE DAS GERÄT ANSCHLIESSEN

Ihre AR-Ausrüstung hat möglicherweise mehr als ein Stromversorgungskabel. Verwenden Sie nur zugelassene Stromkabel. Falls Sie kein Stromkabel oder AC-Netzkabel für dieses Gerät haben, kaufen Sie ein Stromkabel, das für den Einsatz in Ihrem Land zugelassen ist. Das Stromkabel muss für das Gerät, die Spannung und den Strom, die auf dem elektrischen Kennzeichnungsetikett des Geräts markiert sind, zugelassen sein.



Bei einer fehlerhaften Installation oder falls eine Netzspannung verwendet wird, die nicht mit dem Gerät kompatibel ist, erhöht sich die Brandgefahr. Auch andere Gefahren können auftreten. Um einen Stromschlag zu verhindern, schließen Sie das Gerät und die peripheren Stromkabel an ordnungsgemäß geerdete Steckdosen an. Die Kabel sind mit dreipoligen Steckern ausgestattet, um eine korrekte Erdung zu gewährleisten. Verwenden Sie keine Adapter. Entfernen Sie niemals die Erdungsstange eines Kabels.

Modifizieren Sie niemals die Stromkabel oder Stecker. Konsultieren Sie einen lizenzierten Elektriker oder AR-ausgebildeten Servicetechniker, falls Veränderungen am Gerät durchgeführt werden müssen. Halten Sie sich stets an die nationalen/örtlichen Verdrahtungsregeln.



Schalten Sie das Gerät nicht ein, falls es äußerlich beschädigt ist oder Hardware-Teile oder Konsolen fehlen.

SYSTEMERDUNG



Dieses Gerät ist mit einer Schutzerdungsklemme ausgestattet. Die Netzstromquelle muss dem Gerät eine ununterbrochene Systemerdung von ausreichender Größe zur Verfügung stellen, damit Kabelklemmen, Netzkabel oder mitgeliefertes Netzkabel ordentlich befestigt werden können. **VERWENDEN SIE DIESES GERÄT NICHT, wenn dieser Schutz beeinträchtigt ist.**

HINWEISE FÜR DEN SICHEREN GEBRAUCH

GEFÄHRLICHE HF-SPANNUNGEN



Die HF-Spannungen am mittleren Pin eines HF-Ausgangsanschlusses können gefährlich sein. Der HF-Ausgangsanschluss sollte an eine Last angeschlossen werden, bevor das Gerät ans Stromnetz angeschlossen wird. Kommen Sie nicht mit dem Mittelstift des HF-Ausgangsanschlusses oder dem damit verbundenen Zubehör in Kontakt. Bevor Sie die Last vom HF-Ausgang trennen oder diese anschließen, stellen Sie das Gerät in einen nicht betriebsfähigen Zustand.

HÖRSCHUTZ

Sollten die Geräusche, die das Gerät verursacht, 80dB überschreiten, ist Gehörschutz erforderlich.

WARTUNGSHINWEISE

Einstellung, Wartung oder Reparaturen der Ausrüstung dürfen nur von qualifizierten Fachleuten durchgeführt werden. Gefährliche Spannungen können auftreten, wenn Schutzabdeckungen vom Gerät entfernt werden, auch wenn es nicht an die Stromquelle angeschlossen ist. Kontakt kann zu Verletzungen führen. Es können nur bestimmte Ersatzsicherungen mit speziellem Nennstrom verwendet werden.

UMGEBUNGSBEDINGUNGEN

Sofern auf dem Produktspezifikations-Blatt nichts anderes angegeben ist, ist dieses Gerät unter folgenden Bedingungen sicher einsetzbar:

- Gebrauch in Innenräumen
- Höhe bis zu 2000m
- Temperaturen von 5°C bis 40°C
- Maximale relative Luftfeuchtigkeit 80% bei Temperaturen bis 31°C. Lineare Abnahme auf 50% bei 40°C.
- Netzspannungsschwankungen sollen nicht mehr als $\pm 10\%$ der Nennspannung oder der minimal und maximal eingestellten Werte betragen.
- Verschmutzungsgrad 2: Normalerweise nichtleitfähige Verschmutzung mit gelegentlicher Kondensation. Das Gerät wird bei Einsatz in diesem Bereich keine Gefahr verursachen, die Leistung kann dennoch variieren.

LASER-INFORMATION



AR - Feldsonden (FL/PL-Serie) und Feldanalysatoren (FA-Serie) sind Laserprodukte der Klasse 1 mit eingebetteten Klasse-4-Lasern. Bei normalem Gebrauch kann der Laserstrahlung nicht aus den Glasfaserkabel herausdringen. Sicherheitsverriegelungen sorgen dafür, dass der Laser nur aktiviert wird, wenn die Kabel richtig angeschlossen sind. Lassen Sie stets Vorsicht walten bei der Verwendung oder Wartung von Laserprodukten. Niemals direkt hineinschauen.

HF-ANTENNEN

- Die Ausrüstung (Antenne oder Antennenmontage) ist mitunter schwer. Die Montage erfordert daher oft zwei Personen. Folgen Sie allen in diesem Dokument angegebenen Anweisungen zur Anbringung.
- Stellen Sie sicher, dass alle Anschlüsse für den beabsichtigten Betrieb geeignet sind. Informationen zu den Anschlüssen erhalten Sie im Benutzerhandbuch und im Produktspezifikationsblatt.
- Überschreiten Sie nicht den in Spezifikationen angegebenen maximalen HF-Eingangspegel. Informationen zum geeigneten HF-Pegel erhalten Sie im Benutzerhandbuch und im Produktspezifikationsblatt.
- Ein übermäßiger HF-Eingang könnte das Gerät oder die Anschlüsse beschädigen, was zu Sicherheitsrisiken führt.
- Im Betrieb können die HF-Spannungen an den Antennenelementen gefährlich sein. Kommen Sie nicht mit der Antenne oder Antennenelementen in Kontakt, wenn der HF-Eingang an eine live-HF-Quelle angeschlossen ist.
- Um Verletzungen an Personen, am Leistungsverstärker oder der Antenne zu vermeiden, deaktivieren Sie den HF-Ausgang des Leistungsverstärkers, bevor sie die Eingangsverbindung an die Antenne anschließen oder trennen.
- Kontrollieren Sie die Antennen und die Feldsonde regelmäßig, um die nächstfällige Kalibrierung, den ordnungsgemäßen Betrieb und den Gesamtzustand der Ausrüstung zu überprüfen.

RACK MONTIERBARE TWT-MODELLE

Einige TWT-Modelle kommen ohne die abnehmbare Überdachung, die zur Verwendung als Tischgerät dient. Diese rack-montierbaren Modelle verfügen entweder über installierte Tragegriffe oder Rutschflächen. Befolgen Sie alle in diesem Dokument angegebenen Hebehinweise sowie die Installationsanweisungen in der TWT-Bedienungsanleitung.

HEBEANWEISUNGEN FÜR AR-GERÄTE

Die meisten Geräte müssen während des Versands, der Montage und des Gebrauchs transportiert werden. Jeder Nutzer sollte sich über das Risiko von schweren Verletzungen durch unsachgemäße Produkthandhabung bewusst sein. Leitlinien zur Beseitigung von vermeidbaren Verletzungsrisikos, die beim Heben entstehen können, werden in den NIOSH-Arbeitspraktiken (Veröffentlichung # 94-110) zur Verfügung gestellt:



<https://www.cdc.gov/niosh/docs/94-110/pdfs/94-110.pdf>.

Beachten folgende, allgemeine Richtlinien zum Heben eines Gewichts von 50 Pfund oder mehr:

- Verwenden Sie zum Heben der Einheit eine Hebeöse (für Platzierung auf dem Boden) oder Seitengriffe (für Platzierung auf einer Arbeitsplatte).
- Verwenden Sie Geräte mit ausreichender Kapazität zum Heben und Stützen.
- Falls Sie einen Gabelstapler verwenden, achten Sie darauf, dass die Gabeln lange genug sind und über die Seiten der Einheit hinausreichen.
- Für weitere Informationen folgen Sie dem oben angegebenen Link.

INSTRUCTIONS POUR UN FONCTIONNEMENT EN TOUTE SÉCURITÉ









Respectez les consignes de sécurité suivantes pour veiller à votre propre sécurité et vous aider à protéger votre équipement et votre milieu de travail de dommages potentiels.

USAGE PRÉVU

Cet équipement est prévu pour un usage général en laboratoire afin de générer, contrôler et mesurer les niveaux d'énergie de radiofréquence (RF) électromagnétique. Assurez-vous que l'appareil est utilisé dans un endroit qui contrôlera l'énergie rayonnante et ne causera pas de blessure, ni ne violera les niveaux réglementaires d'interférence électromagnétique.

SYMBOLES DE SÉCURITÉ

Ces symboles peuvent apparaître dans votre manuel d'utilisation ou sur l'équipement.

	Ce symbole est apposé sur l'équipement lorsque l'utilisateur doit se référer au manuel pour des informations importantes concernant la sécurité. Le symbole de mise en garde indique un danger potentiel. Vous devez accorder une attention à la déclaration pour éviter tout dommage, destruction ou blessure.
	Présence de tensions dangereuses, soyez très prudent.
	Indique une borne de connexion d'un conducteur externe pour une protection contre l'électrocution en cas de défaillance ou la borne d'une électrode de mise à la terre de protection.
	Indique un rayonnement laser invisible – ne regardez pas directement avec des instruments optiques.
	Indique la borne de connexion de la mise à la terre du cadre ou du châssis.
	Indique un courant alternatif.
	Indique que ce produit ne doit pas être jeté avec vos autres déchets ménagers.
	Indique que la surface marquée et les surfaces adjacentes peuvent atteindre des températures qui risquent d'être chaudes au toucher.

PRÉCAUTIONS D'INSTALLATION DE L'ÉQUIPEMENT



Lisez le manuel d'utilisateur et familiarisez-vous avec tous les marquages et consignes de sécurité. La protection fournie par l'équipement peut être affaiblie s'il est utilisé d'une manière non indiquée par AR RF/instrumentation à hyperfréquence (AR).

- Respectez toutes les instructions de levage indiquées dans ce document.
- Placez l'équipement sur une surface dure et plane.

- N'utilisez pas l'équipement dans un environnement humide, par exemple près d'un lavabo, ou dans un sous-sol humide.
- Positionnez votre équipement de sorte que l'interrupteur d'alimentation soit facilement accessible.
- Laissez un espace minimal de 10,2 cm (4 in) de tous les côtés ventilés de l'équipement pour permettre le flux d'air nécessaire à une bonne ventilation. Ne limitez pas le flux d'air allant dans l'équipement en bloquant tout évent ou entrée d'air. La restriction du flux d'air peut endommager l'équipement, causer des coupures intermittentes ou des dangers pour la sécurité.
- Tenez l'équipement à l'écart de températures extrêmement chaudes ou froides pour veiller à ce qu'il soit utilisé dans la plage de fonctionnement indiquée.
- Lorsque vous installez des accessoires tels que des antennes, des coupleurs directionnels et des sondes de champ, prenez soin d'éviter toute exposition à des niveaux RF dangereux.
- Assurez-vous que rien n'est posé sur les câbles de votre équipement et que les câbles ne se trouvent pas à des endroits où l'on peut marcher dessus ou trébucher.
- Déplacez l'équipement avec soin ; veillez à ce que tous les câbles et/ou roulettes soient solidement raccordés au système. Évitez les arrêts brusques et les surfaces irrégulières.

AVANT LA MISE SOUS TENSION

Votre équipement AR peut disposer de plus d'un câble d'alimentation électrique. Utilisez uniquement un ou des câbles d'alimentation approuvés. Si un câble d'alimentation ne vous a pas été fourni avec l'équipement ou pour toute option alimentée en courant alternatif prévue pour l'équipement, achetez un câble d'alimentation qui est approuvé pour être utilisé dans votre pays. Le câble d'alimentation doit être prévu pour l'équipement et pour le courant et la tension indiqués sur l'étiquette de classement électrique de l'équipement.



Installer ou utiliser de façon incorrecte une tension de ligne incompatible peut augmenter le risque d'incendie ou d'autres dangers. Pour aider à éviter toute électrocution, branchez l'équipement et les câbles d'alimentation périphériques dans des prises électriques correctement mises à la terre. Ces câbles sont équipés de prises à trois broches pour veiller à une bonne mise à la terre. N'utilisez pas d'adaptateur de prise, ni ne retirez la broche de mise à la terre d'un câble.

Ne modifiez pas les câbles ou les prises d'alimentation. Consultez un électricien agréé ou un technicien d'entretien AR qualifié pour les modifications d'équipement. Respectez toujours les règles locales/nationales de câblage.



N'utilisez pas l'équipement s'il est physiquement endommagé ou s'il manque des pièces ou des panneaux.

MISE À LA TERRE DE SÉCURITÉ



Cet équipement est fourni avec une borne de mise à la terre de protection. La source d'alimentation secteur à l'équipement doit fournir une mise à la terre de sécurité ininterrompue de taille suffisante pour attacher les bornes de câblage, le cordon d'alimentation ou l'ensemble de câbles d'alimentation fourni. **N'UTILISEZ PAS cet équipement si cette protection est affaiblie.**

INSTRUCTIONS POUR UN FONCTIONNEMENT EN TOUTE SÉCURITÉ

TENSIONS RF DANGEREUSES

Les tensions RF sur la broche centrale d'un connecteur de sortie RF peuvent être dangereuses. Le connecteur de sortie RF doit être connecté à une charge avant que l'équipement ne reçoive l'alimentation en courant alternatif. N'entrez pas en contact avec la broche centrale du connecteur de sortie RF ou des accessoires raccordés à celle-ci. L'équipement doit être dans un état de non fonctionnement avant de déconnecter ou de connecter la charge au connecteur de sortie RF.



LIMITES ACOUSTIQUES

Si le bruit de l'équipement dépasse 80dB, une protection auditive est nécessaire.

AVERTISSEMENT CONCERNANT L'ENTRETIEN

Le réglage, l'entretien ou la réparation de l'équipement doivent être effectués uniquement par un personnel qualifié. Une énergie dangereuse peut être présente lorsque les couvercles de protection sont retirés de l'équipement, même si celui-ci est déconnecté de la source d'alimentation. Un contact peut causer des blessures. Les fusibles de remplacement doivent être d'un type et courant nominal spécifiques.

CONDITIONS ENVIRONNEMENTALES

Sauf mention contraire sur la fiche signalétique du produit, cet équipement est conçu pour être sécuritaire dans les conditions environnementales suivantes :

- Utilisation à l'intérieur
- Altitude jusqu'à 2000 m
- Température de 5°C à 40°C
- Humidité relative maximale de 80 % pour les températures jusqu'à 31°C. Décroissance linéaire à 50 % à 40°C.
- Les fluctuations de tension d'alimentation principale ne doivent pas dépasser ± 10 % de la tension nominale ou des valeurs d'autorégulation minimales et maximales.
- Degré de pollution 2 : Normalement non conducteur avec une condensation occasionnelle. Bien que l'équipement ne cause pas de condition dangereuse dans cette gamme environnementale, sa performance peut varier.

ÉQUIPEMENT CONTENANT DES LASERS



Les sondes de champ AR (série FL/PL) et les analyseurs de champ (série FA) sont des produits laser de classe 1 contenant des lasers intégrés de classe 4. Lors d'une utilisation normale, le rayonnement laser est entièrement contenu dans les câbles à fibres optiques et ne pose aucun risque d'exposition. Des verrouillages de sécurité veillent à ce que le laser ne soit pas activé à moins que les câbles ne soient correctement raccordés. Soyez toujours prudent lorsque vous utilisez ou entretenez des produits laser. Ne regardez pas directement avec des instruments optiques.

ANTENNES RF

- Cet équipement (antenne ou ensemble antenne) peut être lourd nécessitant deux personnes pour le soulever. Soyez prudent lorsque vous installez ou retirez l'unité. Respectez toutes les instructions concernant l'installation et le levage de l'équipement indiquées dans ce document.

- Assurez-vous que les connecteurs sont appropriés pour l'utilisation prévue. Les connecteurs sont indiqués dans le manuel d'utilisation et la fiche signalétique du produit.
- Ne dépassez pas le niveau d'entrée RF maximal indiqué dans les spécifications. Référez-vous au manuel d'utilisation et à la fiche signalétique du produit pour déterminer les niveaux RF applicables.
- Une entrée RF excessive pourrait endommager l'équipement ou les connecteurs causant des dangers pour la sécurité.
- Lorsque l'équipement fonctionne, les tensions RF sur les éléments de l'antenne peuvent être dangereuses. N'entrez pas en contact avec l'antenne ou les éléments lorsque le connecteur d'entrée RF est connecté à une source RF active.
- Pour éviter que le personnel ne se blesse et que l'amplificateur de puissance ou l'antenne ne soit endommagé, désactivez la sortie RF de l'amplificateur de puissance avant de brancher ou débrancher la connexion d'entrée à l'antenne.
- Effectuez des inspections périodiques de l'antenne et des systèmes de sondes de champ pour vérifier la date d'échéance de la calibration, le bon fonctionnement et l'état global de l'équipement.

MODÈLES TWT MONTÉS SUR BÂTI

Certains modèles TWT sont fournis sans le boîtier amovible proposé pour l'utilisation sur un plan de travail. Ces modèles montés sur bâti peuvent être fournis avec des poignées de transport ou des coulisses et poignées frontales. Respectez toutes les instructions de levage indiquées dans ce document et les instructions d'installation fournies dans le manuel d'utilisation TWT.

INSTRUCTIONS DE LEVAGE POUR L'ÉQUIPEMENT AR

Comme la plupart des produits doivent être manipulés pendant la distribution, l'assemblage et l'utilisation, le risque de blessures graves en raison d'une manipulation dangereuse du produit doit être une considération fondamentale pour chaque utilisateur. Une directive faisant autorité pour éliminer le risque injustifié de blessures causées par le levage est fournie par les méthodes de travail de NIOSH (publication n° 94-110) disponibles sur :



<https://www.cdc.gov/niosh/docs/94-110/pdfs/94-110.pdf>

De façon générale, respectez les directives suivantes pour lever un poids de 50 lb (22 kg) ou plus :

- Utilisez uniquement l'anneau de levage (si posé au sol) ou les poignées latérales (si sur la table) pour soulever l'unité.
- Utilisez un équipement de capacité adéquate pour soulever et supporter l'unité.
- Si vous utilisez un chariot élévateur pour déplacer l'unité, assurez-vous que les fourches sont assez longues pour s'étendre au-delà du côté de l'unité.
- Pour plus d'informations, suivez le lien indiqué ci-dessus.

INSTRUCTIES VOOR VEILIG GEBRUIK



Neem de volgende veiligheidsrichtlijnen in acht om uw persoonlijke veiligheid te helpen waarborgen en uw apparaat en werkomgeving tegen mogelijke schade te beschermen.

BEOOGD GEBRUIK

Dit apparaat is bedoeld voor algemeen laboratoriumgebruik bij het genereren, regelen en meten van niveaus van elektromagnetische radiofrequentie(RF)-energie. Zorg ervoor dat het apparaat wordt gebruikt op een locatie die de uitgestraalde energie controleert, geen letsel veroorzaakt of de reglementaire niveaus van elektromagnetische interferentie schendt.

VEILIGHEIDSSYMBOLEN

Deze symbolen kunnen in uw gebruikershandleiding of op uw apparaat verschijnen.

	Dit symbool staat op het apparaat als de gebruiker de handleiding moet raadplegen voor belangrijke veiligheidsinformatie. Het waarschuwingssymbool geeft een mogelijk gevaar aan. Er moet aandacht worden besteed aan de verklaring om schade, vernietiging of letsel te voorkomen.
	Er zijn gevaarlijke elektrische spanningen aanwezig. Wees uiterst voorzichtig.
	Wijst op een terminal aan die bedoeld is voor aansluiting op een externe geleider voor bescherming tegen elektrische schokken in het geval van een storing, of de terminal van een veiligheidselektrode (aarding).
	Wijst op een onzichtbare laserstraling - bekijk niet rechtstreeks met optische instrumenten.
	Wijst op het frame of het chassis van de aardingsterminal.
	Wijst op wisselstroom.
	Geeft aan dat dit product niet bij het huishoudelijk afval mag worden weggegooid.
	Geeft aan dat het gemarkeerde oppervlak en de aangrenzende oppervlakken temperaturen kunnen bereiken, die warm aanvoelen.

VOORZORGSMAATREGELEN BIJ DE INSTALLATIE VAN HET APPARAAT



Raadpleeg de gebruikershandleiding en leer alle veiligheidsmarkeringen en -instructies kennen. De bescherming die door het apparaat wordt geboden, kan worden belemmerd bij gebruik op een manier die niet wordt vermeld door AR RF/Microwave Instrumentation (AR).

- Respecteer alle tilinstructies die in dit document vermeld zijn.
- Plaats het apparaat op een hard, waterpas oppervlak.
- Gebruik het apparaat niet in een natte omgeving, bijvoorbeeld in de buurt van een gootsteen of in een vochtige kelder.
- Plaats uw apparaat zodanig dat de aan/uit-schakelaar gemakkelijk bereikbaar is.

Revisie 0517

- Laat een vrije ruimte van 10,2 cm (4 inch) aan alle geventileerde zijden van het apparaat om de luchtstroom die nodig is voor goede ventilatie mogelijk te maken. Belemmer de luchtstroom in het apparaat niet door ventilatieopeningen of luchtinlaten te blokkeren. Het belemmeren van de luchtstroom kan leiden tot schade aan het apparaat, onregelmatige uitval van veiligheidswaarschuwingen.
- Houd het apparaat uit de buurt van extreem hoge of lage temperaturen om ervoor te zorgen dat het apparaat binnen het gespecificeerde werkbereik wordt gebruikt.
- Bij de installatie van accessoires zoals antennes, directionele koppelingen en terreinsondes, moet u ervoor zorgen dat blootstelling aan gevaarlijke RF-niveaus wordt voorkomen.
- Zorg ervoor dat er niets op de kabels van uw apparaat rust en dat de kabels zich niet op een plaats bevinden, waar er op getrapt kan worden of waar er over gestruikeld kan worden.
- Verplaats de apparatuur voorzichtig; zorg ervoor dat alle zwenkwielen en/of kabels stevig op het systeem zijn aangesloten. Vermijd plotselinge stops en oneffen oppervlakken.

VOOR HET OPZETTEN VAN DE STROOM

Uw AR-apparatuur kan meer dan een netvoedingskabel bezitten. Gebruik alleen goedgekeurde netvoedingskabel(s). Koopt een netvoedingskabel die is goedgekeurd voor gebruik in uw land als u geen netvoedingskabel hebt ontvangen voor de apparatuur of voor een door wisselstroom aangedreven optie, die bedoeld is voor de apparatuur. De netvoedingskabel moet geschikt zijn voor het apparaat en voor de spanning en stroomsterkte die op het label met de elektrische classificatie van het apparaat staat vermeld.



Het verkeerd installeren of gebruiken van een incompatibele netspanning kan het risico op brand of andere gevaren verhogen. Sluit het apparaat en de perifere netvoedingskabels aan op geaarde stopcontacten om elektrische schokken te helpen voorkomen. Deze kabels zijn uitgerust met driepolige stekkers om voor een goede aarding te zorgen. Gebruik geen adapterstekkers of verwijder de aardingspen van een kabel niet.

Pas geen netvoedingskabels of stekkers aan. Raadpleeg een bevoegde elektricien of een door AR opgeleide servicemonteur voor aanpassingen van de apparatuur. Respecteer altijd uw lokale/nationale bedravingsreglementering.



Gebruik de apparatuur niet als er sprake is van fysieke schade, ontbrekende hardware of ontbrekende panelen.

AARDING



Deze apparatuur is voorzien van een beschermende aardingsterminal. De stroombron van de apparatuur moet een ononderbroken veiligheidsaarding van voldoende grootte leveren om de aansluitklemmen, de netvoedingskabel of de meegeleverde netvoedingskabelset aan te sluiten. **GEBRUIK dit apparaat NIET als deze bescherming is beschadigd.**

INSTRUCTIES VOOR VEILIG GEBRUIK

GEVAARLIJKE RF-SPANNINGEN

De RF-spanning op de middelste pin van een RF-outputconnector kan gevaarlijk zijn. De RF-uitgangconnector moet op een massa worden aangesloten voordat er wisselstroom op het apparaat wordt geplaatst. Raak de middelste pin van de RF-outputconnector of de accessoires die erop zijn aangesloten, niet aan. Plaats het apparaat in een niet-werkende staat voordat u de massa loskoppelt of verbindt met de RF-outputconnector.



AKOESTISCHE BEPERKINGEN

Als het geluid van het apparaat 80dB overschrijdt, is gehoorbescherming vereist.

ONDERHOUD WAARSCHUWING

Aanpassing, onderhoud of reparatie van de apparatuur mag alleen worden uitgevoerd door gekwalificeerd personeel. Er kan gevaarlijke energie aanwezig zijn terwijl beschermende afdekkingen van de apparatuur worden verwijderd, zelfs als deze van de stroombron is losgekoppeld. Contact kan tot persoonlijk letsel leiden. Wisselzekeringen moeten van het hetzelfde type en dezelfde stroomsterkte zijn.

OMGEVINGSVOORWAARDEN

Tenzij anders op het productspecificatieblad is vermeld, is dit apparaat ontworpen om veilig te zijn onder de volgende omgevingsomstandigheden:

- Binnengebruik
- Hoogte tot 2000 m
- Temperatuur van 5 °C to 40 °C
- Maximale relatieve vochtigheid 80% voor temperaturen tot 31 °C. Lineair afnemend tot 50% bij 40 °C.
- Schommelingen in de netspanning mogen niet groter zijn dan ± 10 % van de nominale spanning of minimum en maximum autobereikwaarden.
- Vervuilinggraad 2: Normaal niet-geleidend met incidentele condensatie. Hoewel het apparaat geen gevaarlijke toestand veroorzaakt boven dit omgevingsbereik, kunnen de prestaties variëren.

APPARAAT DAT LASERS BEVAT



AR-terreinsondes (FL/PL-serie) en terreinanalysatoren (FA-serie) zijn laserproducten van klasse 1 met ingesloten klasse 4-lasers. Bij normaal gebruik is de laserstraling volledig vervat in de glasvezelkabels en vormt ze geen bedreiging voor blootstelling. Veiligheidsvergrendelingen zorgen ervoor dat de laser niet wordt geactiveerd, tenzij de kabels correct zijn aangesloten. Wees altijd voorzichtig bij het gebruik of het onderhoud van laserproducten. Bekijk niet rechtstreeks met optische instrumenten.

RF-ANTENNES

- Dit apparaat (antenne of antenne-set) kan zwaar zijn, waardoor er twee personen nodig zijn om het op te tillen. Wees voorzichtig bij het installeren of verwijderen van het apparaat. Respecteer alle instructies voor het instellen en optillen van de apparatuur, die in dit document worden vermeld.
- Zorg ervoor dat de connectoren geschikt zijn voor de beoogde werking. De connectoren worden gespecificeerd in de gebruikershandleiding en in het productspecificatieblad.
- Overschrijd het maximale RF-ingangsniveau niet, dat in de specificaties is vermeld. Raadpleeg de gebruikershandleiding en het productspecificatieblad om de toepasselijke RF-niveaus te bepalen.
- Een overmatige RF-input kan het apparaat of de connectoren beschadigen en veiligheidsrisico's veroorzaken.
- De RF-spanningen op de antenne-elementen kunnen gevaarlijk zijn tijdens het gebruik. Raak de antenne of elementen niet aan wanneer de RF-ingangconnector is aangesloten op een actieve RF-bron.
- Om persoonlijk letsel en onopzettelijke schade aan de vermogensversterker of antenne te voorkomen, schakelt u de RF-output van de vermogensversterker uit voordat u de inputaansluiting op de antenne aansluit of loskoppelt.
- Voer periodieke inspecties uit van de antenne- en terreinsondesystemen om de vervaldatum van de kalibratie, de juiste werking en de algehele conditie van de apparatuur te controleren.

IN EEN REK GEMONTEERDE TWT-MODELLEN

Sommige TWT-modellen worden geleverd zonder de verwijderbare behuizing die wordt aangeboden voor gebruik als tafemodel. Deze modellen die in een rek kunnen worden gemonteerd, kunnen worden geleverd met handgrepen of sledes en handgrepen die aan de voorkant zijn geïnstalleerd. Volg alle tilinstructies in dit document en de installatie-instructies in de gebruikershandleiding van de TWT.

TILINSTRUCTIES VOOR AR-APPARATUUR

Omdat de meeste producten tijdens de distributie, de assemblage en het gebruik moeten worden behandeld, moet het risico op ernstig letsel als gevolg van een onveilige behandeling van het product een fundamentele overweging voor elke gebruiker zijn. Een gezaghebbende richtlijn voor het elimineren van ongerechtvaardigd risico op letsel veroorzaakt door tillen, wordt aangeboden door de NIOSH-Work Practices (publicatie # 94-110) en is beschikbaar op:



<https://www.cdc.gov/niosh/docs/94-110/pdfs/94-110.pdf>.

Neem in het algemeen de volgende richtlijnen in acht voor het optillen van een gewicht van 25 kg of meer:

- Gebruik alleen het hijsorg (vloermodel) of de zijhandgrepen (tafelmodel) om de eenheid op te tillen.
- Gebruik apparatuur met voldoende capaciteit om de eenheid op te tillen en te ondersteunen.
- Als u een vorkheftruck gebruikt om de eenheid te verplaatsen, zorg er dan voor dat de vorken lang genoeg zijn om tot voorbij de zijkant van het eenheid uit te steken.
- Volg de link hierboven voor meer informatie.

TABLE OF CONTENTS

TABLE OF CONTENTS	i
1. GENERAL INFORMATION	1
1.1 General Description	1
1.2 Specifications.....	1
1.3 Power Supplies	2
1.4 Protection Circuits	2
1.5 Installation	3
1.5.1 Location	3
1.5.2 AC Power.....	3
1.5.3 Driver Output Cables.....	4
1.5.4 RF MPA Output Cables.....	4
1.6 Other Connections	4
1.6.1 Amplifier Input Connector.....	5
1.6.2 RF Sample Ports	5
1.6.3 Amplifier Output Connector.....	5
1.6.4 Safety Interlock Connector	5
2. OPERATING INSTRUCTIONS.....	9
2.1 General.....	9
2.2 Control and Indicator Functions	9
2.3 Interface Identification and Diagrams	10
2.3.1 RF Input	11
2.4 Operator Command and Control Interface	11
2.4.1 Local Control Interface	12
2.4.1.1 Keylock Switch	12
2.4.1.2 Power Button.....	12
2.4.1.3 Adjust Knob	12
2.4.1.4 Touch Screen.....	12
2.4.1.5 Menu Map	12
2.4.1.5.1 Inhibit Screen	13
2.4.1.5.2 Main Menu Screen	14
2.4.1.5.3 Select Screen	15
2.4.1.5.4 Mode Screen.....	15
2.4.1.5.5 User Screen	16
2.4.1.5.6 More Screen	16
2.4.1.5.7 I/O Screen.....	17
2.4.1.5.8 GPIB Address Screen.....	17
2.4.1.5.9 RS-232/Fiber-Optic Serial Baud Rate Screen	18
2.4.1.5.10 Key Beep Screen	18
2.4.1.5.11 Remote Screen.....	19
2.4.1.5.12 Fault Screen.....	19
2.4.2 Remote Control Interface.....	20
2.4.2.1 GPIB (IEEE-488) Communication	20
2.4.2.1.1 Setting the GPIB (IEEE-488) Address	20
2.4.2.2 RS-232 Communication	20
2.4.2.3 Fiber-Optic Serial Communication	21
2.4.2.4 USB Communication	22
2.4.2.5 Ethernet Communication.....	22

2.4.2.6	Remote Commands.....	23
2.4.2.6.1	Power On/Off.....	24
2.4.2.6.2	RF On/Off.....	24
2.4.2.6.3	Reset Faults.....	25
2.4.2.6.4	Mode Select	25
2.4.2.6.5	Level Adjust.....	25
2.4.2.6.6	Identity	26
2.4.2.6.7	IO Board Firmware Revision.....	26
2.4.2.6.8	Machine State	27
2.4.2.6.9	State	28
2.4.2.6.10	Forward Power.....	29
2.4.2.6.11	Reverse Power	29
2.4.2.6.12	RF Gain.....	30
2.4.2.6.13	Faults.....	30
2.4.2.6.14	Operating Hours (RF On)	31
2.4.2.6.15	Operating Hours (Power On).....	31
2.4.2.6.16	Initiate MPA Coolant Temperature and Transistor Currents.....	31
2.4.2.6.17	Query MPA Coolant Temperature and Transistor Currents	32
2.4.2.6.18	Remote Operating Timeout	32
2.4.2.6.19	ALC Board Firmware Revision.....	33
2.4.2.6.20	SBB (Piggyback) Firmware Revision.....	34
2.4.2.6.21	SBB (Optical) Firmware Revision.....	34
2.4.2.6.22	System Serial Number	35
2.4.2.6.23	AC Power-On Defaults	35
2.4.2.7	Interlocks	36
2.4.2.7.1	Inhibit Interlock	36
2.4.2.7.2	AC Interlock	36
2.5	RF Output.....	37
2.6	Electrical Power	37
3.	THEORY OF OPERATION.....	39
3.1	General	39
3.2	Amplifier	39
3.2.1	Amplifier RF Input.....	39
3.2.2	A1 RF Module.....	39
3.2.3	Driver Power Supplies (PS1, PS2).....	39
3.2.4	A5 Control/Fault Board (Schematic #10030013).....	40
3.2.5	A10 Voltage Regulator Board.....	40
3.2.6	Splitter, Attenuator	40
3.2.7	Main Power Amplifier Unit (MPA)	40
3.2.8	Liquid-Cooled Module.....	41
3.2.9	Output Combiner/Directional Coupler, Detector Assembly	41
3.2.10	Sample Ports.....	41
3.3	Power Supply	41
3.4	Control Circuits	42
3.4.1	Fiber-Optic System Control Link.....	42
3.4.2	Power On/Operate Circuits	42
3.4.3	Automatic Level Control Circuits	43
3.5	Fault Detection Circuits.....	44
3.5.1	Thermal Faults.....	44
3.5.2	Current Faults.....	44
3.5.2.1	Over-current.....	44
3.5.2.2	Under-current.....	45

3.5.3	Power Supply Faults	45
3.5.4	ALC Fault	45
3.5.5	Interlocks	45
3.5.5.1	Inhibit Interlock.....	45
3.5.5.2	AC Interlock.....	45
3.5.6	System Error (F/O Link Fault).....	46
4.	TROUBLESHOOTING AND REPAIR	47
4.1.	General.....	47
4.3	Fault Signal Interpretation and Diagnosis.....	47
4.3.1	General - Reading Faults	47
4.3.2	Power Supply Faults	48
4.3.3	Thermal Faults	48
4.3.4	ALC Fault	48
4.3.5	RF Module Faults	48
4.3.6	Fault Troubleshooting Guide.....	49
4.4	Diagnosing and Replacing Amplifier Modules	50
4.4.1	Locating Modules	50
4.4.2	Module Replacement.....	51
4.4.3	Cooling System.....	51
	Appendix A. Installing Software Upgrades	53
A.1	Firmware Updates.....	53
A.2	Control - Multi-Purpose Board Assembly Firmware (x1).....	53
A.3	I/O - Input Output Board Assembly Firmware (x1)	54
A.4	Breakout - Piggy-Back Connected Switch Breakout Board (SBB) Assembly Firmware (x1)	54
A.5	Breakout - Fiber-Optic Connected Switch Breakout Board (SBB) Assembly Firmware in MPAs (x4).....	55
A.6	Automatic Leveling Control (ALC) Assembly Firmware (x1)	55
A.7	Assemblies that require physical replacement to update firmware.....	56

LIST OF FIGURES

1-1	1200A225 AC Line Cord Installation.....	3
1-2	1200A225 Connector Locations (Rear View Left, Front View, Right).....	4
2-1	Digital Control Panel (DCP) Features	9
2-2	Rear Panel Features	10
2-3	Model 1200A225 Interface Block Diagram	10
2-4	Control State Diagram	11
2-5	Menu Map.....	13
2-6	Inhibit Screen.....	13
2-7	Main Menu Screen.....	14
2-8	Select Screen.....	15
2-9	Mode Screen	15
2-10	User Screen.....	16
2-11	More Screen.....	16
2-12	I/O Screen	17
2-13	GPIB Address Screen	17
2-14	RS-232 Fiber-Optic Serial Baud Rate Screen.....	18
2-15	Key Beep Screen.....	18
2-16	Remote Screen	19
2-17	Fault Screen	19
4-1	1200A225 MPA/Module Locations (Rear View).....	50

LIST OF TABLES

2-1	RS-232 Port Settings	21
2-2	RS-232 (DCE) Port Pinout Diagram DB-9 Female	21
2-3	Fiber-Optic Serial Port Settings	22
2-4	Relationships between the Model 1200A225 Controls and Remote Communication	24
2-5	Machine State Response Time	27
2-6	Bit Position	28
2-7	Faults	30
3-1	Link States	42

1. GENERAL INFORMATION

1.1 GENERAL DESCRIPTION

The Model 1200A225 is a self-contained, broadband, completely solid-state Radio Frequency (RF) amplifier designed for applications where instantaneous bandwidth and high gain are required. The amplifier is air cooled, with internal liquid cooling of the final amplifier stages. Push-pull circuitry is utilized in all high-power stages to minimize distortion and improve stability. The Model 1200A225, when used with a RF sweep generator, will provide a minimum of 1200 watts of swept power covering the frequency range from 0.01 to 100MHz, derating to 1100 watts from 100 MHz to 225 MHz. The Model 1200A225 is housed in a single stylish contemporary equipment cabinet.

Special features incorporated into the Model 1200A225 include the following:

- **A Digital Control Panel (DCP)** that allows both local and remote (via a computer interface) control of the amplifier (including adjustment of the amplifier's RF Gain during CW mode operation) and provides graphical displays of the amplifier's Forward and Reflected power levels.
- **Automatic Level Control (ALC)** by internal circuits or by an external input; with front panel (via the unit's DCP) or remote (via the unit's computer interface) control of the ALC Threshold setting.
- **RF output level protection.**
- **A General Purpose Interface Bus (GPIB)/IEEE-488.2 interface** for remote control of the amplifier's operating functions.
- **RS232 serial communications** including both wire and fiber-optic ports for remote control.
- **USB and Ethernet Communication ports** for remote control.
- **Protection** is provided by DC current limiting, over-current, under-current, and over-temperature shut down and RF power limiting.
- **Housed in a stylish contemporary equipment rack**, the Model 1200A225 provides readily available RF power for typical applications such as RF susceptibility testing, antenna and component testing, and wattmeter calibration.

1.2 SPECIFICATIONS

Refer to the AR RF/Microwave Instrumentation Data Sheet at the end of this section for detailed specifications.

1.3 POWER SUPPLIES

The Model 1200A225 is a modular design with each section having self-contained power supplies. These power supplies are self-contained, regulated switching units.

The Main Power Amplifier (MPA) unit has a supply providing +42V as the main source of power for the amplifier circuitry. Also included in this unit is a +5V supply for logic and control functions and a +24V supply that runs the coolant pump, heat exchanger fans and main combiner fan.

The Driver/Control (DCU) section contains a +37V supply providing DC power for the power amplifier module and for the A8 Regulator assembly. It also contains one other power supply: a unit providing +5, +15, and -15V for control and logic.

1.4 PROTECTION CIRCUITS

Features incorporated into this unit include RF output level protection circuits, thermal protection circuits, output device current monitoring and limiting of individual power amplifier modules. There is a main system AC circuit breaker and secondary AC circuit breakers in the Driver/Control unit (DCU) and the main power amplifier (MPA) unit. Both main switching supplies are short circuit protected. Reaching a threshold of either of the RF forward (incident) or reverse (reflected) power limit adjustments, which are adjusted to approximately 1250 watts and 600 watts respectively, will initiate limiting, or smooth drive level fold-back, in a low-level stage of the amplifier chain. If the limiting circuits cannot keep the amplifier's levels below the limit threshold, the protection circuits will invoke a shutdown of the main power supplies and low-level driver in the amplifier. Power amplifier modules are monitored for both over-current and under-current. A **RESET** function is provided to permit re-powering of the amplifier in case of transient or temporary activation of the amplifier's protection circuitry. The low-level driver and output amplifier subassemblies are thermally monitored.

The cooling system is monitored and protected. Each power amplifier module incorporates a thermal switch which will shut down the power supplies in the event of an over-temperature condition. Liquid coolant is monitored for temperature, flow and level. Over-temperature of the fluid, low coolant flow, or low coolant level will shut down the amplifier and send a notification to the front panel display.

The digital control panel monitors all fault signals, stores and displays any that are invoked and asserts the required action.

1.5 INSTALLATION

Before proceeding, thoroughly inspect the amplifier for signs of physical damage that may have been incurred during shipment and completely read the following installation and operating instructions, paying special attention to all **CAUTION** notes.

1.5.1 Location

Select an operating location that will permit free air circulation around the amplifier's cabinet. The Model 1200A225 utilizes air cooling and should be located where the normal flow of air into or exiting from the unit will not be restricted, diverted, or re-circulated through the unit itself. For example, do not position the unit next to a wall or other equipment that would cause a restriction of airflow into or out of the unit.



CAUTION:

Under normal operating conditions, the exhaust air temperature may exceed 40°C. Do not locate heat sensitive equipment, objects or materials in the exhaust air stream of the unit.

1.5.2 AC Power

The Model 1200A225 is designed for a primary power input of 200–240 VAC, 50/60Hz, single phase, 4.6kW maximum.

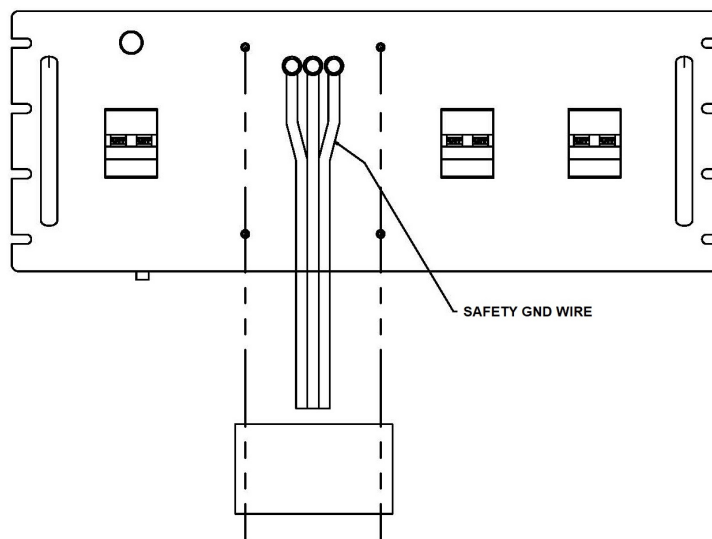

Figure 1-1. 1200A225 AC Line Cord Installation

Due to the variety of power systems available, line cords are not shipped with this unit. The user must install the recommended supply line in the unit. The Model 1200A225 requires a line cord having #8AWG or larger conductors. To install the line cord, referring to Figure 1-1, remove the power distribution box cover, located at the middle of the cabinet, in the rear. Do not cause any wires attached to the rear panel to be pulled tightly. Loosen the strain relief clamp nut and insert a prepared line cord of the proper gauge and size. Connect the green/yellow earth ground to the designated ground stud, using the appropriate hardware. Connect the phase and neutral wires to the top designated terminal studs. Tighten the strain relief nut and replace the rear panel.

CAUTION:



Dangerous voltages are present in the amplifier whenever it is plugged into an AC outlet. Always disconnect the unit from the main power line when servicing it. Please note that neither the Keylock Switch nor the Power switch will completely shut off the unit's AC power.

1.5.3 Driver Output Cables

Driver output cables are normally left connected for shipment. If for any reason they are disconnected, they must be re-connected. The connectors should be labeled. The cables are of uniform length and can be interchanged without affecting the operation of the amplifier.

1.5.4 RF MPA Output Cables

If, for any reason, the amplifier has disconnected RF MPA output cables, they must be installed in the proper positions. The RG393 cables, with Type N right-angle male connectors, attach between the RF MPAs and the output combiner input ports.

1.6 OTHER CONNECTIONS

See Figures 1-2 and 2-2.

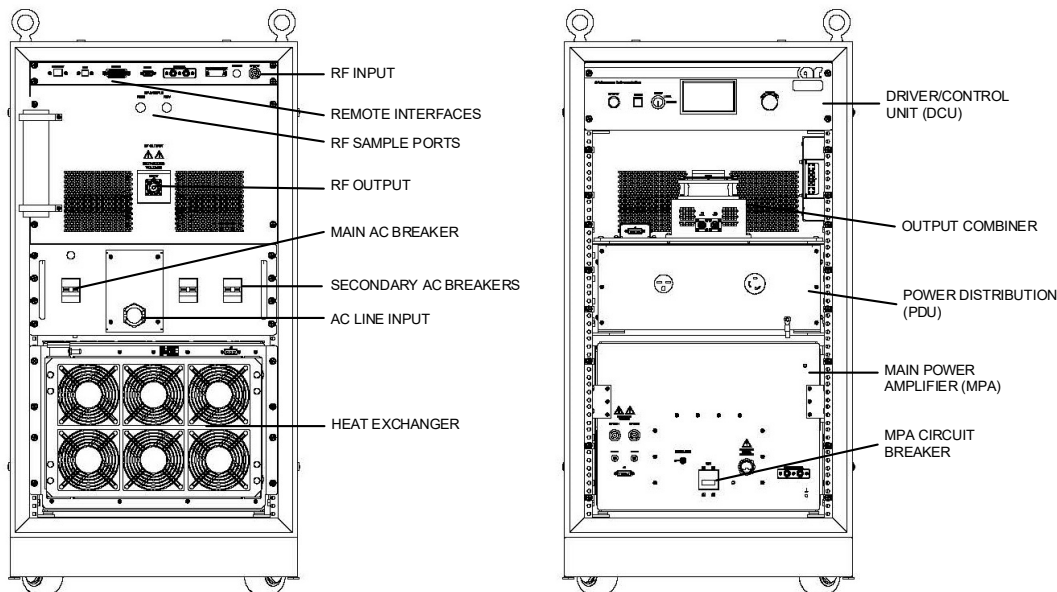

Figure 1-2. Model 1200A225 Connector Locations (Rear View Left, Front View, Right)

1.6.1 Amplifier Input Connector

The Type N RF input connector for the amplifier can be located on the front or rear of the driver/control unit.

1.6.2 RF Sample Ports

The optional Forward and Reverse power sample port connectors are located on the rear of the amplifier rack. Cables and equipment connected to these ports should exhibit resistive 50-ohm impedance throughout the band. They are normally used for operating external power meters. A calibration table is provided with the Model 1200A225 that provides a list of external RF power meter offset values. The offset values completely characterize the directional coupler/forward sample port circuit attenuation across the frequency band, and are available in electronic form. Additional attenuation may be necessary when using RF power meters with diode detector sensors, as most require a maximum signal no greater than -20 dBm.

1.6.3 Amplifier Output Connector

The amplifier RF output connector is a 7/16 DIN female type located on the rear of the amplifier.



CAUTION:

Placing the amplifier in the operate mode without a load connected to the output connector is not recommended.

1.6.4 Safety Interlock Connector

Located on the rear of the driver/control unit is the amplifier I/O panel, which includes remote interface connectors and safety interlock connectors. The 15-pin D-sub miniature female safety interlock connector provides two separate interlock loops. Pins 1 and 8 are used for situations where the amplifier can be left on, but forced into STANDBY mode. This interlock is called Inhibit Interlock. Pins 10 and 14 are used for situations that demand the safest possible condition, with the AC power to all main circuits disconnected. This interlock is called AC Interlock. Both loops must be closed, or jumpered, for normal operation.



1200A225

- 1200 Watts CW
- 10kHz–225MHz
- Class A
- Portable
- Full VSWR-tolerant
- CE & RoHS Compliant

Features

The Model 1200A225 is a solid-state, self-contained, broadband amplifier designed for applications where instantaneous bandwidth, high gain and linearity are required. The amplifier is air-cooled using internal self-contained liquid cooling for high performance and reliability. A stylish, contemporary enclosure allows for easy portability.

The Model 1200A225, when used with a sweep generator, will provide a minimum of 1200 watts of RF power. Included is a front panel gain control which permits the operator to conveniently set the desired output level. The 1200A225 is protected from RF input overdrive by an RF input leveling circuit which controls the RF input level to the RF amplifier first stage when the RF input level is increased above 0dBm. The RF amplifier stages are protected from over-temperature by removing the DC voltage to them if an over-temperature condition occurs due to cooling blockage or fan failure. The Model 1200A225 is equipped with a Digital Control Panel (DCP) which provides both local and remote control of the amplifier. The DCP uses a color LCD touch screen display

to indicate the operate status and fault conditions if an over-temperature or power supply fault has occurred. The unit can be returned to operate when the condition has been cleared.

All amplifier control functions and status indications are available remotely through the included Remotes Package. The Remotes Package includes GPIB/IEEE-488 format, RS-232C hardware and fiber optic, USB, and Ethernet. The bus interface connector is located on the back panel and positive control of local or remote operation is assured by a Local/Remote keyswitch on the front panel of the amplifier. Also included with the Remotes Package is a safety interlock circuit for use with external safety switch interlocks. This circuit prevents the amplifier from going into operate mode unless the external connection is made. A jumper plug is provided for cases where this functionality is not needed.

The export classification for this equipment is EAR99.

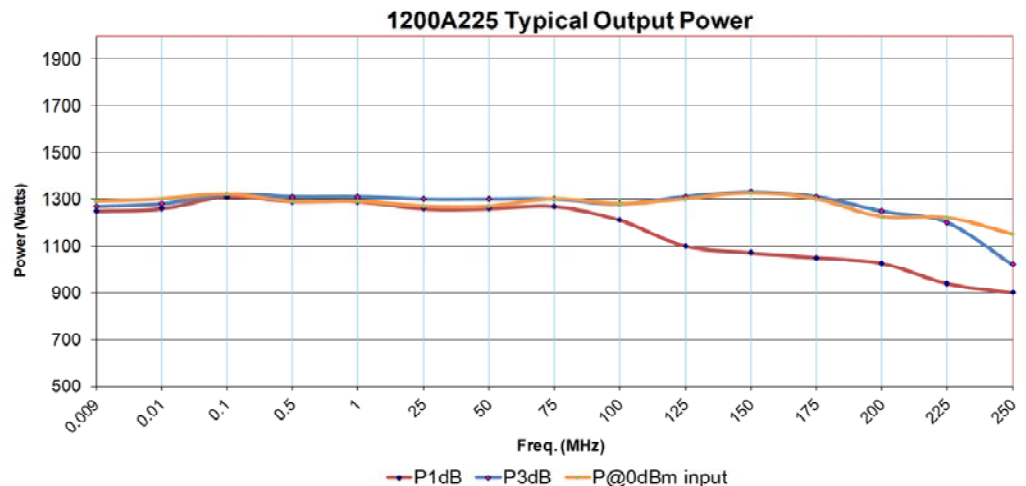

AR RF/Microwave
Instrumentation
160 School House Rd
Souderton, PA 18964
215-723-8181

For an applications engineer call: 800.933.8181

www.arworld.us

ISO 9001 Certified



1200A225

- 1200 Watts CW
- 10kHz-225MHz

Specifications

RATED OUTPUT POWER:

Typical: 1300 watts, min 1200 watts, .01-100MHz
 Typical: 1200 watts, min 1100 watts, 100-225MHz

INPUT FOR RATED OUTPUT: 1.0 mW Max

POWER OUTPUT @ 3dB COMPRESSION:

Typical: 1300 watts, min 1200 watts, .01-100MHz
 Typical: 1200 watts, min 1100 watts, 100-225MHz

POWER OUTPUT @ 1dB COMPRESSION:

Typical: 1250 watts, min 1100 watts, .01-100MHz
 Typical: 1050 watts, min 800 watts, 100-225MHz

FLATNESS: ±2.0 dB typical, ±2.5 dB maximum

FREQUENCY RESPONSE: 10kHz-225 MHz instantaneously

GAIN (at maximum setting): 61.8 dB minimum

GAIN ADJUSTMENT (Continuous Range): 20 dB

INPUT IMPEDANCE: 50 ohms, VSWR 1.5:1 maximum

OUTPUT IMPEDANCE: 50 ohms nominal

MISMATCH TOLERANCE: 100% of rated power without foldback up to 6.0:1 mismatch, above which may limit to 600W reflected power.

MODULATION CAPABILITY: Will faithfully reproduce AM, FM, or Pulse modulation appearing on input signal.

THIRD ORDER INTERCEPT: 78 dBm typical

NOISE FIGURE: 8.5 dB typical

HARMONIC DISTORTION: Minus 30 dBc typical, minus 20 dBc maximum at 750 watts

SPURIOUS: Minus 70 dBc typical

PRIMARY POWER: 200-240 VAC single-phase, 50/60Hz, 4.6 kWatts

CONNECTORS:

RF Input: N female
 RF Output: 7/16 DIN female

REMOTES PACKAGE:

IEEE-488: 24-pin female
 RS-232: 9-pin subminiature D (female)
 Fiber optic: ST Conn Tx and Rx RS-232
 USB 2.0: Type B
 Ethernet: RJ-45
 Safety Interlock: 15-pin subminiature D

COOLING: Forced air, internal self-contained liquid

WEIGHT: 139 kg (305 lbs)

SIZE (W x H x D): 56.1 x 115 x 88.9 cm (22.1 x 45.25 x 35 in)

ENVIRONMENTAL:

Operating Temperature: 5°C / +40°C
 Operating Altitude: Up to 2000M
 Shock and vibration: Normal Truck Transport

REGULATORY COMPLIANCE:

EMC EN 61326-1
 Safety UL 61010-1
 CAN/CSA C22.2 #61010-1
 CENELEC EN 61010-1
 RoHS DIRECTIVE 2011/65/EU

EXPORT CLASSIFICATION: EAR99

Ordering Options



CONNECTOR LOCATION	
Front	F
Rear	R

Contact your AR RF/Microwave Instrumentation Sales Associate for specific model configuration pricing.

1200A225

- 1200 Watts CW
- 10kHz-225MHz

Typical Gain @ -20 dBm input

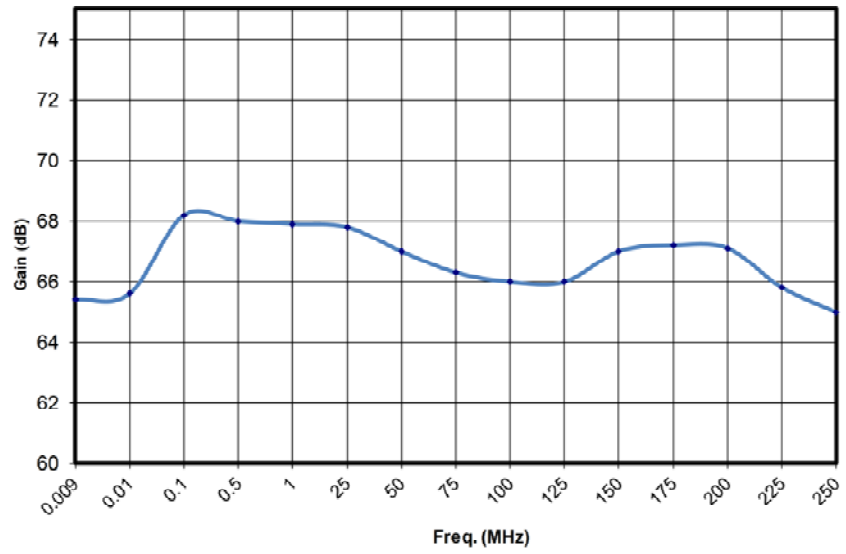

Typical Harmonics @ 750 watts

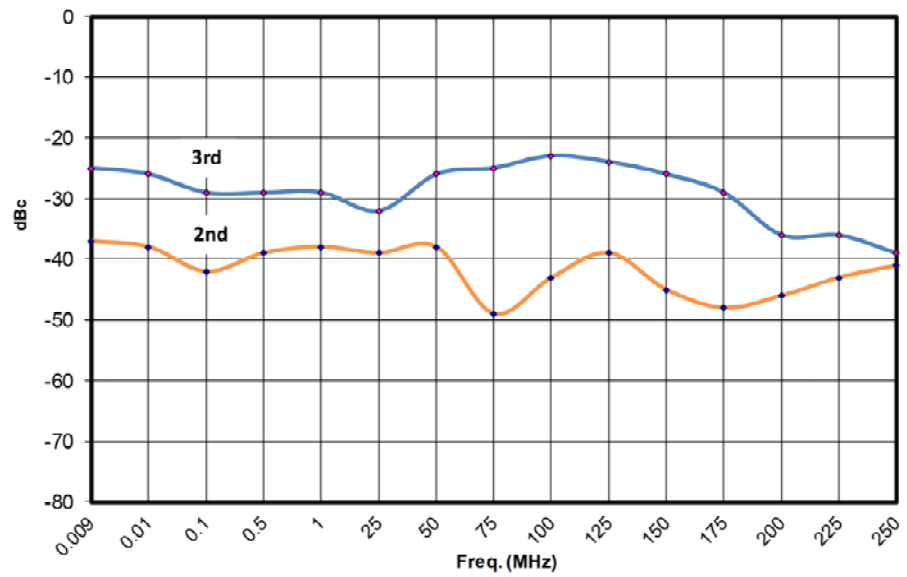

1200A225

- 1200 Watts CW
- 10kHz-225MHz

Typical Input VSWR

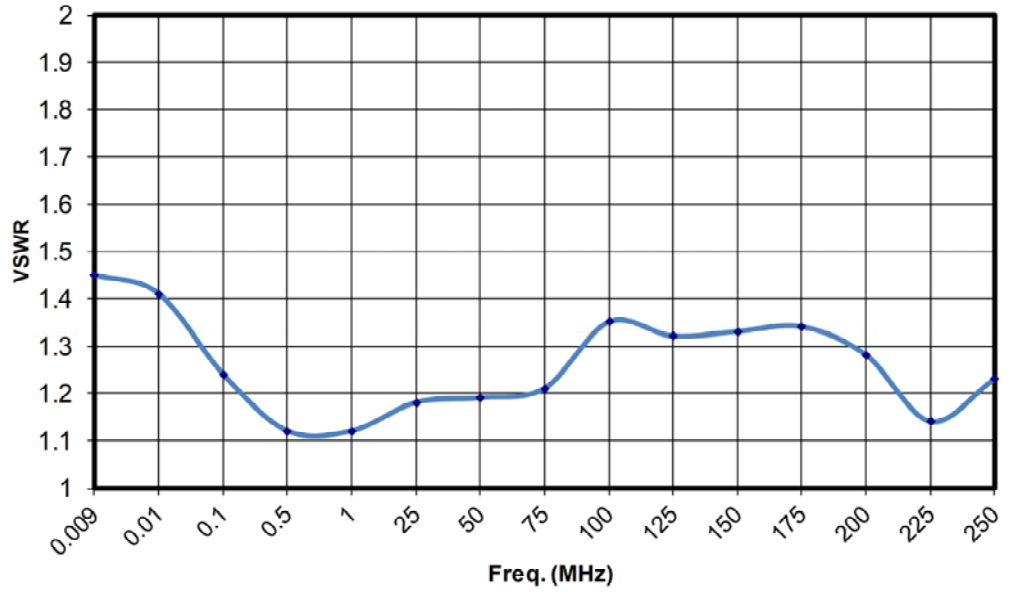

Typical Noise Figure vs. Frequency

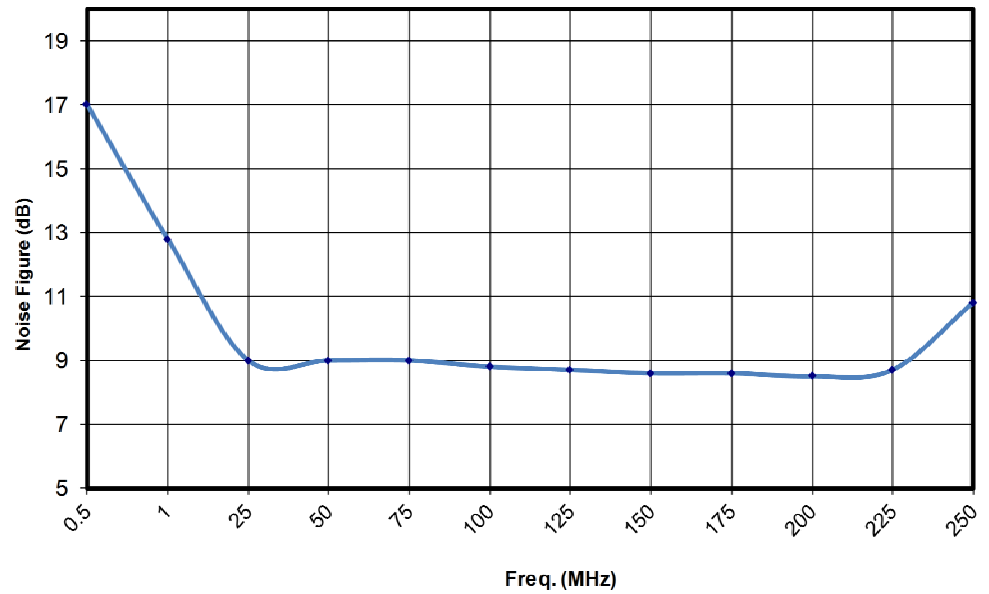

Envelope Drawing

1200A225

- 1200 Watts CW
- 10kHz-225MHz

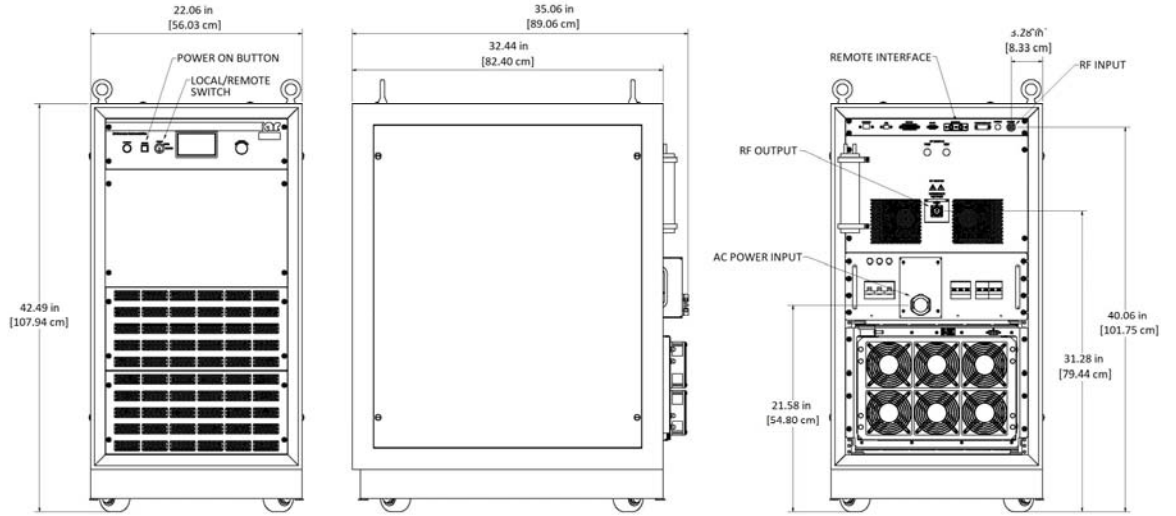

2. OPERATING INSTRUCTIONS

2.1 GENERAL

Operation of the Model 1200A225 broadband amplifier is quite simple. The amplifier's input signal, whether swept or fixed in frequency, is fed into the jack marked **RF INPUT**, and the amplifier's output signal is taken from the jack labeled **RF OUTPUT**. The unit is turned on by activating the front panel **POWER** switch. In the event of a major malfunction, protection is provided by a circuit breaker located on the unit's rear panel.



CAUTION:

The Model 1200A225 Amplifier is *typically* not critical in regard to source and load Voltage Standing Wave Ratio (VSWR) and will remain unconditionally stable with any magnitude and phase of source and load VSWR. However, placing the amplifier in the operate mode without a load connected to the output connector is not recommended. It has also been designed to withstand, without damage, RF input power levels up to +13 dBm (20 mW). However, signal levels higher than 20mW or transients with high peak voltages can damage the amplifier. Also, accidental connection of the Model 1200A225's output to its input (either through direct connection or parasitic feedback paths) will cause oscillations that may permanently damage the unit's input transistors.

2.2 CONTROL AND INDICATOR FUNCTIONS

The Model 1200A225's front panel is shown in Figure 2-1; the unit's rear panel features are detailed in Figure 2-2.

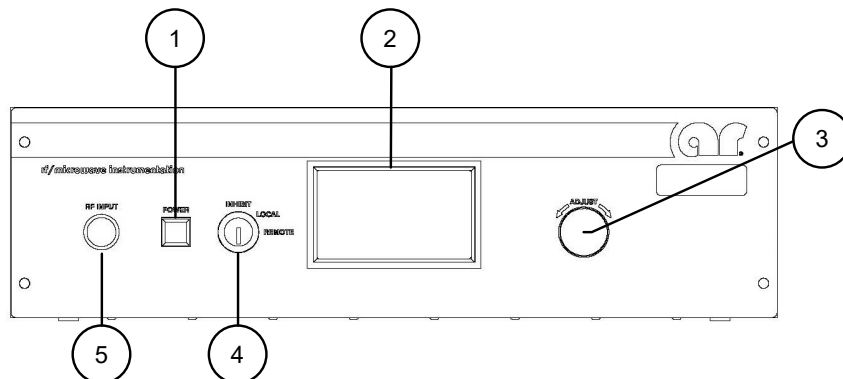

Figure 2-1 Digital Control Panel (DCP) Features

Item	Title	Description
1	POWER	POWER control with indicator LED
2	DISPLAY	Numerous parameter values and fault messages
3	ADJUST	Adjust knob to change selected variables
4	INHIBIT, LOCAL, REMOTE	Keylock Switch, 3-position; key removal in INHIBIT position only
5	RF INPUT	RF input connector

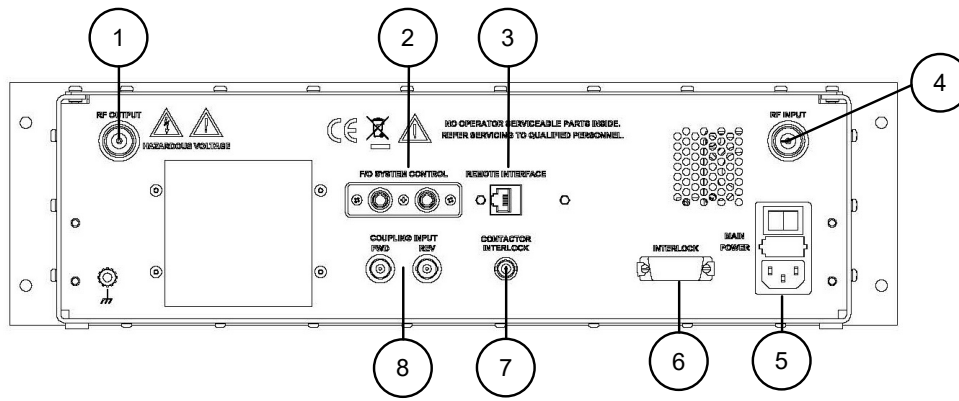

Figure 2-2. Rear Panel Features

Item	Title	Description
1	RF Output	Type N connector
2	F/O System Control	Fiber optic system control link; ST connectors (Tx and Rx)
3	Remote Interface	RJ-11 connector
4	RF Input	Type N
5	AC Power Inlet	200-240
6	Interlock	15-pin DIN
7	Contactor Interlock	Type BNC
8	Fwd/Rev Coupled Input	Type BNC

2.3 INTERFACE IDENTIFICATION AND DIAGRAMS

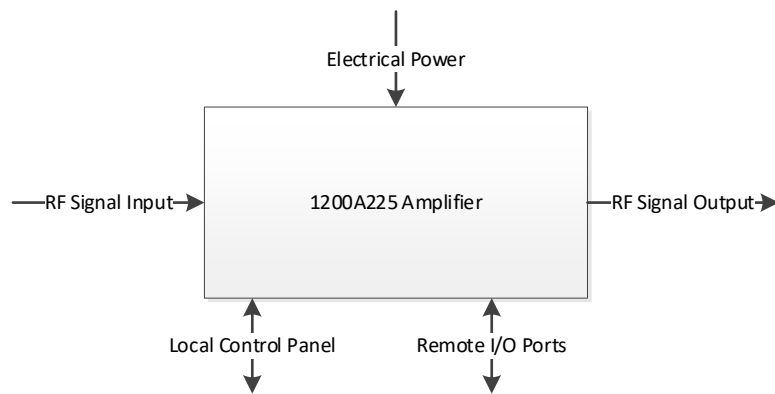

Figure 2-3. Model 1200A225 Interface Block Diagram

2.3.1 RF Input

Input to the Model 1200A225 is accomplished through a female N-Type RF connector (50 ohm) found on either the front or rear of the unit.

2.4 OPERATOR COMMAND AND CONTROL INTERFACE

This section describes the local and remote interface control of the Model 1200A225 amplifier. The Keylock switch on the control panel is used to select between three control options. These are Local, Remote and Inhibit.

The Local option allows for control of the Model 1200A225 using the control panel located on the front of the unit. The Remote option allows for control of the Model 1200A225 using any of the remote (I/O) ports found on the rear of the unit. The Inhibit option allows the Model 1200A225 to be placed into a locked state preventing both local and remote control.

Figure 2-4 shows the state diagram for the Power and RF states of the Model 1200A225. This diagram should be used to understand the major states that the Model 1200A225 can be in. For simplicity of the diagram, the Keylock switch position is only listed where relevant.

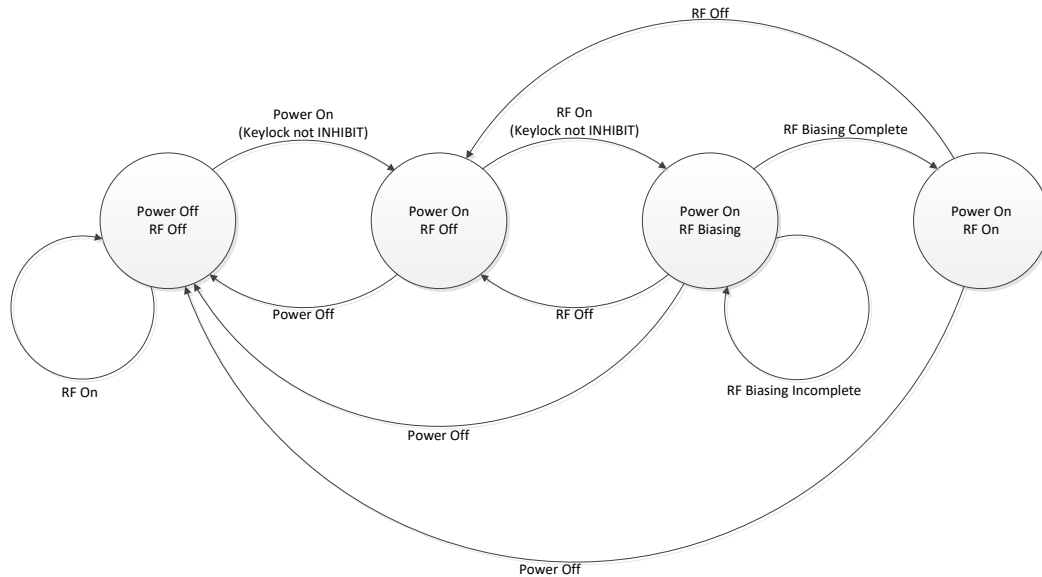

Figure 2-4. Control State Diagram

2.4.1 Local Control Interface

This section describes local operation of the Model 1200A225 using the human interface items found on the control panel.

2.4.1.1. Keylock Switch

The Keylock Switch is provided for protection from unauthorized use or unexpected remote control of the Model 1200A225. The Model 1200A225 can only be turned on locally when the Keylock Switch is in the LOCAL position. Likewise, the unit can only be turned on or controlled remotely when the Keylock Switch is in the REMOTE position. Placing the Keylock Switch in the INHIBIT position places the Model 1200A225 into an RF off state and prohibits any control of the Model 1200A225. All remote queries are processed and responded to in any of the three Keylock switch positions.

2.4.1.2 Power Button

The momentary POWER button turns the main power to the Model 1200A225 on and off. The status of the green light-emitting diode (LED) in the switch indicates whether the Model 1200A225's power is on or off. The main power supply fans are active when power is on. The LCD touch display is active as long as the main circuit breaker for the Model 1200A225 power entry module is on.

2.4.1.3 Adjust Knob

The ADJUST knob is used to set the value of several parameters available through the touch screen menu options. These parameters are RF Gain, ALC Threshold, ALC Detector Gain, and ALC Response. The Select Menu is used to select which parameter the ADJUST knob will adjust. The range of RF Gain, ALC Threshold, and ALC Detector Gain is 0 to 100 percent. The range of the ALC Response is 1 to 7. The ADJUST knob can be rotated both clockwise and counterclockwise 360 degrees.

2.4.1.4 Touch Screen

The touch screen is a color LCD that can accept single touch events from soft blunt objects such as a human finger. The mechanism that registers touch events is resistive based and relies on pressure not capacitance. Menu options presented on the touch screen are typically gray in color with a black text label in the center. When a valid touch event is registered a thin black box appears around the valid touch location and an optional audible beep will occur.

2.4.1.5 Menu Map

Figure 2-5 shows the menu map for the Model 1200A225. The screens depicted are only example screens. The actual values and settings will be different on the actual amplifier depending on user settings and operating conditions.

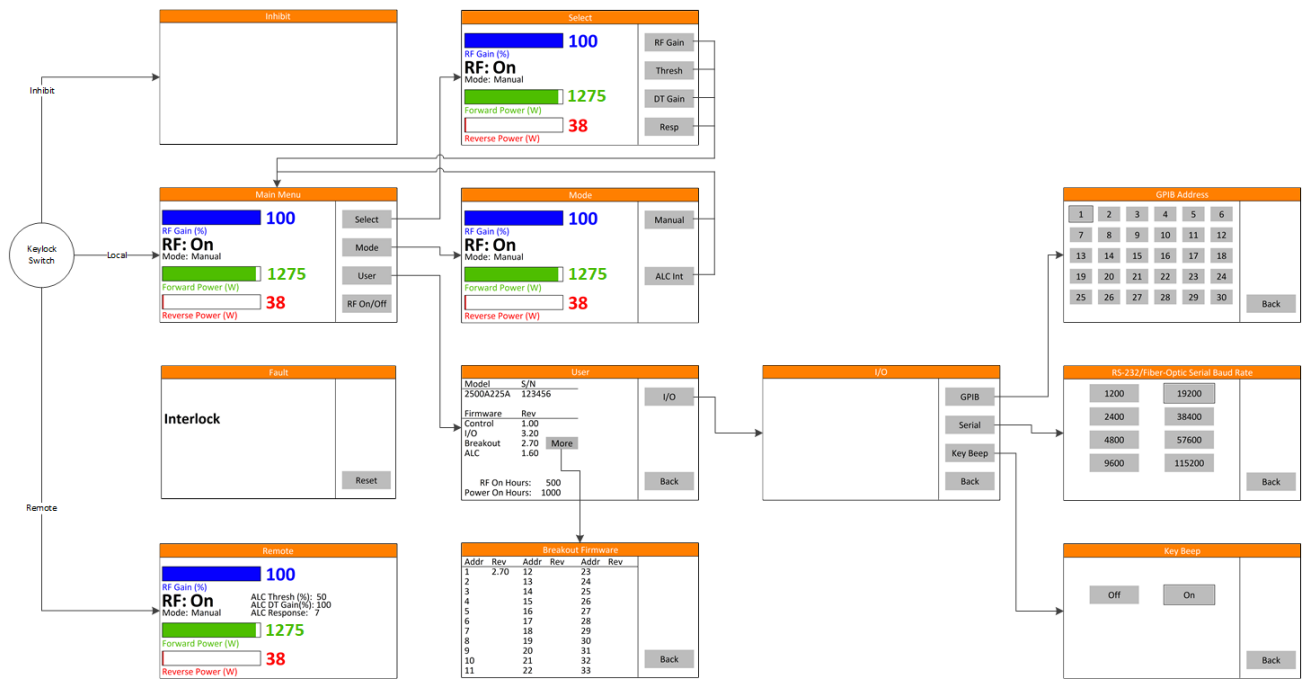

Figure 2-5. Menu Map

2.4.1.5.1 Inhibit Screen

The Inhibit screen is used as an indication to the user that the Model 1200A225 is in an inhibited mode. In Inhibit Mode, the POWER button cannot be used, and no touch screen menu options are available. In addition, the ADJUST knob is disabled.



Figure 2-6. Inhibit Screen

2.4.1.5.2 Main Menu Screen

The Main Menu screen is only available when the Keylock switch is in the LOCAL position.

At the top of the screen is the RF Gain, ALC Threshold, ALC Detector Gain, or ALC Response value in the form of a blue bar graph and associated blue numeric value. See Section 2.4.1.3 for range information.

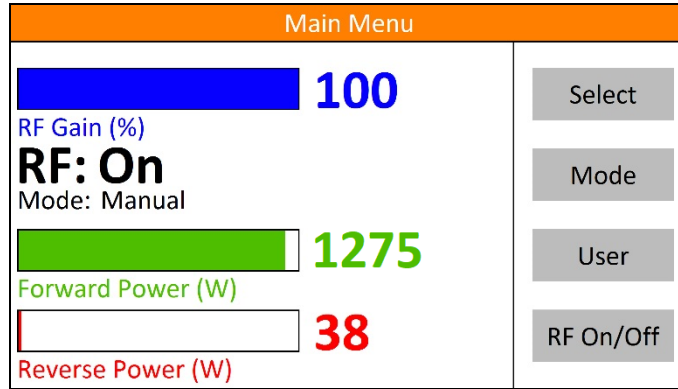

Figure 2-7. Main Menu Screen

In the left center of the screen is the Automatic Leveling Control (ALC) Mode which can be Manual/Continuous Wave (CW) or ALC Internal.

The RF state is shown in bold lettering which can be either Off, Biasing, or On.

At the bottom of the screen are the forward and reverse power indicator bar graphs and associated values in Watts. The scale of the bar graphs is based on a range of 0 to rated power. For the Model 1200A225 rated power is 2500Watts. The forward power is indicated in green while the reverse power is indicated in red.

The menu options available from the main menu are Select, Mode, User, and RF On/Off.

Select brings up the selection menu for the assignment of the ADJUST knob. Mode brings up the menu for the selecting the ALC mode. User brings up the User screen and menu.

RF On/Off enables or disables the RF path through the Model 1200A225. Pressing RF On will first put the Model 1200A225 into a biasing state. When the biasing process is complete (approximately 7 to 10 seconds in duration) the Model 1200A225 will go to an RF On state.

2.4.1.5.3 Select Screen

The Select screen is the same as the Main Menu screen with the exception of the menu options. The menu options in this screen allow the user to select what parameter the ADJUST knob can adjust. Once a selection is made, the screen will automatically change back to the Main Menu screen. The blue bar graph and associated value will change to reflect the value of the selected item.

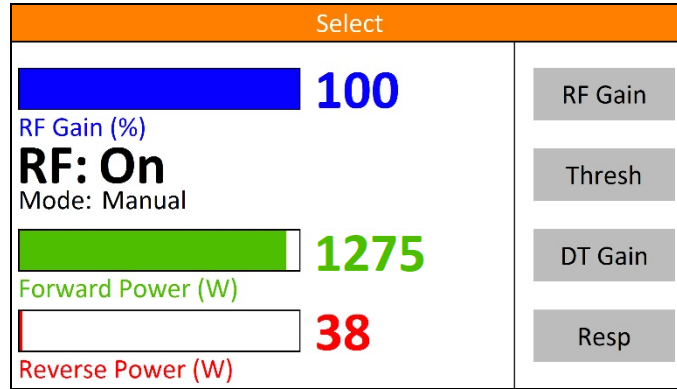

Figure 2-8. Select Screen

2.4.1.5.4 Mode Screen

The Mode screen is the same as the Main Menu screen with the exception of the menu options. The menu options in this screen allow the user to select the ALC mode. Once a selection is made, the screen will automatically change back to the Main Menu screen. The Mode indicator will change to reflect the selected mode.

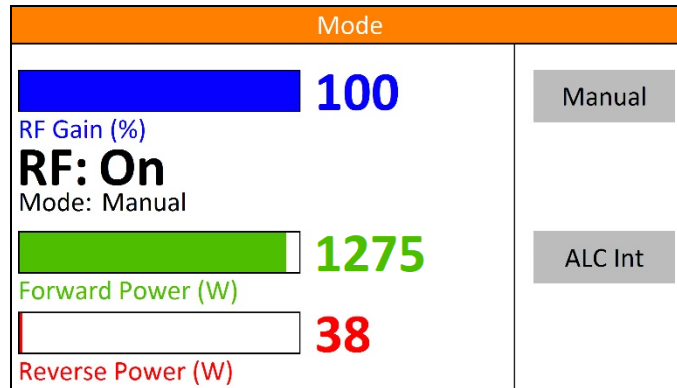

Figure 2-9. Mode Screen

2.4.1.5.5 User Screen

The User screen presents the user with the revision levels of all the firmware that is running on all the main control system components. For the Switch Breakout Board (SBB) assemblies, only the piggy-back assembly firmware is listed. The More button allows the user to see the firmware revisions for all of the fiber-optically connected instances of these assemblies. At the bottom of the screen the RF On and Power On Operating Hours are displayed. A menu option is provided for accessing the settings for the remote I/O ports found on the rear of the unit.

User			
Model	S/N		
1200A225	123456		I/O
Firmware	Rev		
Control	1.00		
I/O	3.20		
Breakout	2.70	More	
ALC	1.60		
RF On Hours:	500		Back
Power On Hours:	1000		

Figure 2-10. User Screen

2.4.1.5.6 More Screen

The More screen shows the firmware revisions for all of the fiber-optically connected instances of SBB assemblies. The address numbers represent the position of each SBB assembly in the fiber-optic serial chain. Addresses 1 represent the 1 SBB assembly found in the Major Power Amplifier (MPA).

Breakout Firmware					
Addr	Rev	Addr	Rev	Addr	Rev
1	2.70	12		23	
2		13		24	
3		14		25	
4		15		26	
5		16		27	
6		17		28	
7		18		29	
8		19		30	
9		20		31	
10		21		32	
11		22		33	
					Back

Figure 2-11. More Screen

2.4.1.5.7 I/O Screen

The I/O screen is used to present the user with menu options pertaining to the remote I/O ports found on the rear of the unit and the interaction with the touch screen. These options include the GPIB address, RS-232/Fiber-Optic Serial Baud Rate, and key beep.



Figure 2-12. I/O Screen

2.4.1.5.8 GPIB Address Screen

The GPIB address screen is used to select the GPIB address. Touching any of the buttons labeled 1 to 30 immediately sets the GPIB address to the corresponding value. A thin black outline indicates the present GPIB address selection. When the back button is pushed the address selection is stored to non-volatile memory. Therefore, if power is lost prior to hitting the back button any address selection changes will be lost. The default GPIB address is 1.

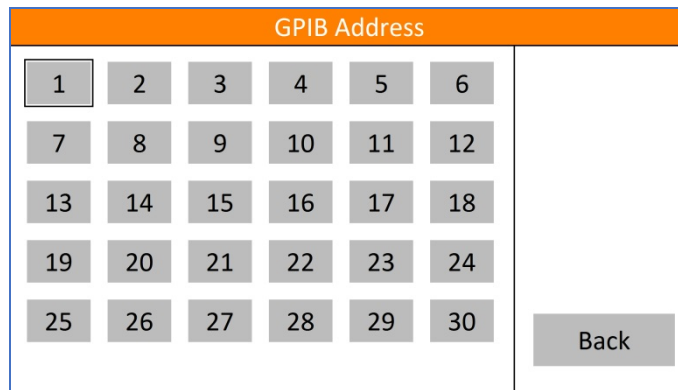

Figure 2-13. GPIB Address Screen

2.4.1.5.9 RS-232/Fiber-Optic Serial Baud Rate Screen

The RS-232/Fiber-Optic Serial Baud Rate screen is used to select the baud rate used by both the RS-232 port and the Fiber-Optic Serial port. A thin black outline indicates the present baud rate selection. When the back button is pushed the baud rate selection is stored to non-volatile memory. Therefore, if power is lost prior to hitting the back button any baud rate selection changes will be lost. The default baud rate is 19200.

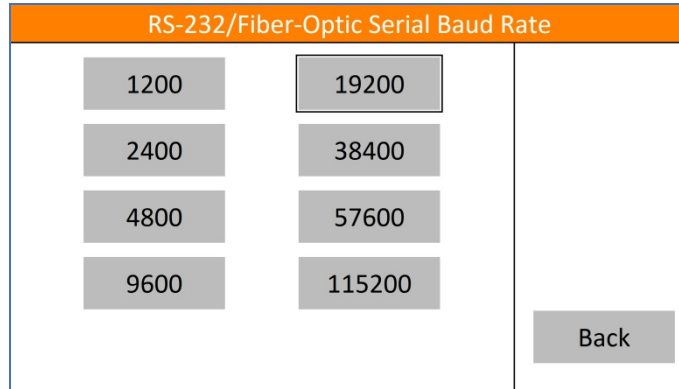

Figure 2-14. RS-232/Fiber-Optic Serial Baud Rate Screen

2.4.1.5.10 Key Beep Screen

The Key Beep screen allows the user to turn on or off the audible beep that occurs when a valid touch event takes place. This setting is only stored in volatile memory and will be lost when power to the unit is cycled. The default value for this setting is On.

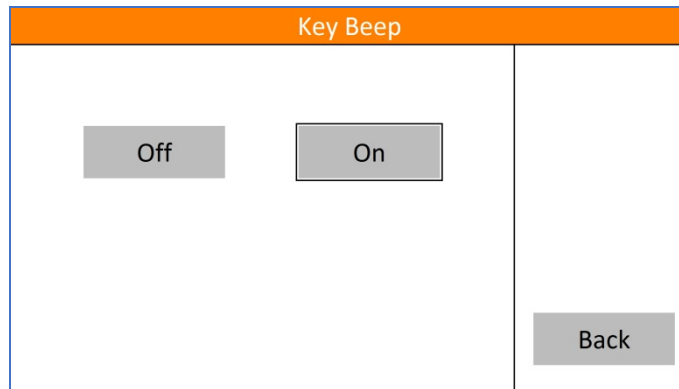

Figure 2-15. Key Beep Screen

2.4.1.5.11 Remote Screen

When the Keylock switch is set to the REMOTE position the Remote screen appears. This screen has all the same information as the Main Menu screen except that the blue bar graph and associated value are only for the RF Gain value. Because of this, the ALC Threshold, ALC Detector Gain, and ALC Response values are displayed separately in black toward the center of the screen.

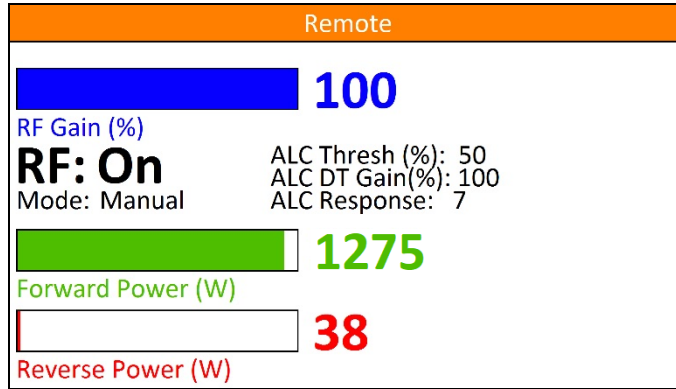

Figure 2-16. Remote Screen

2.4.1.5.12 Fault Screen

The Fault screen will appear anytime that a fault condition is met. The name of the fault is shown toward the center of the screen. In either LOCAL or REMOTE Keylock switch positions, a Reset button will appear allowing local resetting of the fault condition. Faults can also be reset remotely. If the fault reset is successful, the screen will return to the Main Menu or Remote screen depending on the Keylock switch position.

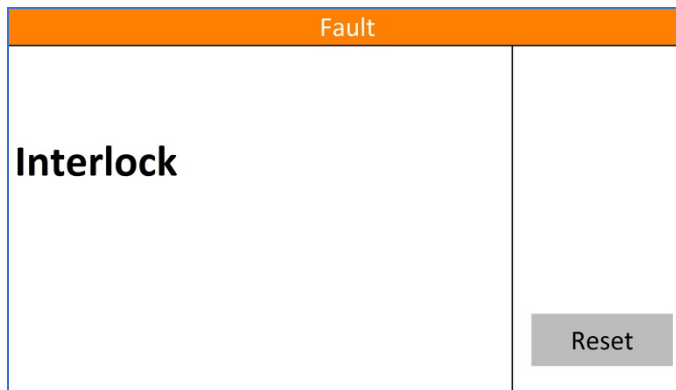

Figure 2-17. Fault Screen

2.4.2 Remote Control Interface

This section describes remote operation of the Model 1200A225 using the provided General Purpose Interface Bus (GPIB), RS-232, Fiber-Optic Serial, Universal Serial Bus (USB), and Ethernet ports connected to a remote device such as a personal computer. All ports are active at all times, however only one port may be used at a time. Communicating through two or more ports at one time will cause data collisions and lost commands or queries.

The Keylock switch on the control panel of the Model 1200A225 allows it to be controlled using remote communications. All remote queries will work in any Keylock switch position, but all remote commands will only work when the position is set to REMOTE. When the Keylock switch is set to REMOTE all front panel controls are disabled unless otherwise specified.

Due to the high power output capability of the Model 1200A225 there is a built-in safety mechanism while the Keylock switch is in the REMOTE position. Once the RF is instructed to go to an on state, it is necessary to continually communicate over any of the remote I/O ports on a periodic basis. The timing for this periodic basis is determined by the Remote Operate Timeout (ROPTO) command found in Section 2.4.2.6.18.

2.4.2.1 GPIB (IEEE-488) Communication

For GPIB operation, the device address is set using the front panel touch screen. Ensure that each device connected to the GPIB is set to a unique address.

To send commands be sure that the Model 1200A225's address is set properly and that the controller has correctly identified it as a "listening" device.

When sending commands via the GPIB interface, terminate with an EOI and a Line Feed character. The 1200A225 will ignore characters following the termination.

2.4.2.1.1 Setting the GPIB (IEEE-488) Address

The GPIB device address can be set to any number between 1 and 30. This selection is made by navigating to the GPIB address selection screen (Section 2.4.1.5.8). To get there from the Main Menu, touch the User menu button followed by the I/O menu button and finally the GPIB menu button. Touching any of the buttons labeled 1 to 30 immediately sets the GPIB address to the corresponding value. A thin black outline indicates the present GPIB address selection. When the back button is pushed the address selection is stored to non-volatile memory. Therefore, if power is lost prior to hitting the back button any address selection changes will be lost. The default GPIB address is 1.

2.4.2.2 RS-232 Communication

The RS-232 port is a serial communications bus. All commands and queries through this port must be terminated with a Line Feed character. When a valid query is received, it is processed and the result is immediately transmitted back over the RS-232 interface. This port is designed to time-out if there is no activity on the bus for more than 5 seconds. At this time, the internal buffer is cleared and a TIMEOUT_ERROR message followed by a Line Feed character is sent out from this port.

The baud rate for the RS-232 port is user selectable from the RS-232/Fiber-Optic Serial Baud Rate selection screen. To get there from the Main Menu, touch the User menu button followed by the I/O menu button and finally the Serial menu button. A thin black outline indicates the present baud rate selection. When the back

button is pushed the baud rate selection is stored to non-volatile memory. Therefore, if power is lost prior to hitting the back button any baud rate selection changes will be lost. The default baud rate is 19200.

NOTE: This baud rate setting is shared by both the RS-232 port and the Fiber-Optic serial port.

The RS-232 port is setup as a Data Circuit-terminating Equipment (DCE) port. When connecting to a Personal Computer (PC) a straight one-to-one cable should be used. A null modem is NOT needed. The settings and pinout diagram for this port can be found below.

Table 2-1. RS-232 Port Settings

Word Length	8 bits
Stop Bits:	1
Baud Rate:	User selectable (default is 19200)
Parity:	None
HW Handshake:	None

Table 2-2. RS-232 (DCE) Port Pinout Diagram DB-9 Female

Pin 1	DCD
Pin 2	TD
Pin 3	RD
Pin 4	DTR
Pin 5	GND
Pin 6	DSR
Pin 7	CTS
Pin 8	RTS
Pin 9	Unused

2.4.2.3 Fiber-Optic Serial Communication

The Fiber-Optic port is a serial communications bus. All commands and queries through this port must be terminated with a Line Feed character. When a valid query is received, it is processed and the result is immediately transmitted back over the Fiber-Optic interface. This port is designed to time-out if there is no activity on the bus for more than 5 seconds. At this time, the internal buffer is cleared and a TIMEOUT_ERROR message followed by a Line Feed is sent out from this port.

The baud rate for the Fiber-Optic Serial port is user selectable from the RS-232/Fiber-Optic Serial Baud Rate selection screen. To get there from the Main Menu, touch the User menu button followed by the I/O menu button and finally the Serial menu button. A thin black outline indicates the present baud rate selection. When the back button is pushed the baud rate selection is stored to non-volatile memory. Therefore, if power is lost prior to hitting the back button any baud rate selection changes will be lost. The default baud rate is 19200.

NOTE: This baud rate setting is shared by both the Fiber-Optic serial port and the RS-232 port.

The Fiber-Optic port provides the user with the ability to optically isolate the controlling PC from the Model 1200A225. This can be useful in an environment where RF/Microwave energy could be coupled onto a connection to one of the “wired” communications ports and fed back to the controlling PC.

Both optical connections (TX and RX) are optimized to work with light at a wavelength of 820nm. For more detailed specifications on this port, consult the Avago HFBR series datasheet found at www.avagotech.com.

A glass, multi-mode, fiber-optic cable of 200um is recommended, however fiber-optic cable as small as 50um can be used. The connector type for this port is ST.

This port can be used in conjunction with either an AR Model IF7000 RS-232 to Fiber-Optic Interface (1200 to 9600 baud only) or an AR Model IF7001 USB to Fiber-Optic Interface (19200 baud only). Note that these devices use SMA connectors so a fiber-optic cable is needed with ST connectors on one end and SMA connectors on the other. This cable can be obtained from a fiber-optic cable distributor such as Fiber Instrument Sales (FIS). Their web-site can be found at www.fiberinstrumentsales.com. An example cable that will work for this connection is FIS Part Number D615M7FIS. The 7 in the part number refers to the length of the cable. In this case the length is 7 meters.

Table 2-3. Fiber-Optic Serial Port Settings

Word Length	8 bits
Stop Bits:	1
Baud Rate:	User selectable (default is 19200)
Parity:	None
HW Handshake:	None

2.4.2.4 USB Communication

The USB port is a USB 2.0 port. It also complies with the USB Test and Measurement Class (USBTMC) Standard. Communications with this port requires the host computer to have a USBTMC driver available. All commands and queries through this port must be terminated with a Line Feed character.

The cable required to make this connection is a USB 2.0 A-B peripheral device cable. The cable can be no longer than 5 meters. If a longer distance is required a USB hub must be used. A cable carrying the official USB logo is recommended.

When connected to a PC running Windows 2000 or XP a window will pop-up labeled Hardware Wizard. If this PC has National Instruments LabView installed it will have a USBTMC driver that will work with this port. This driver will allow the device to be easily controlled using National Instruments Measurement and Automation Explorer or LabView. It should be noted that the USBTMC driver provided by National Instruments is a Virtual Instrument Software Architecture (VISA) driver which can be used with other programming languages besides LabView. For more information on this please consult the National Instruments Website found at www.ni.com.

NOTE: All firmware updates are done through the USB port.

2.4.2.5 Ethernet Communication

The Ethernet port allows remote control through a Transmission Control Protocol (TCP) data channel. All commands and queries through this port must be terminated with a Line Feed character.

By default, this port is setup to work on a network with a Dynamic Host Configuration Protocol (DHCP) server. Upon connection, an Internet Protocol (IP) address is assigned based on the internal Media Access Control (MAC) address. The MAC address is printed on a label located near the Ethernet port.

If the connected network does not have DHCP enabled then the device can be assigned an IP address by the user. To do this, download the utility called DeviceInstaller™ from www.Lantronix.com. For assistance using this utility please consult the utilities embedded help file.

The DeviceInstaller™ utility will scan the network and find all connected Lantronix Ethernet devices. This list of found devices will include any connected AR Ethernet devices. By selecting one of the connected devices from the list, its IP address and subnet mask can be changed along with a number of other settings. One should use caution in adjusting any settings he/she is unfamiliar with as doing so may cause the port to become unresponsive. By default, the port for the TCP data channel is 10001.

*DHCP is a protocol used to assign a dynamic IP address to a device. Network server software will assign an available IP address to a device when it is connected and powered on. Different IP addresses may be assigned at different times.

2.4.2.6 Remote Commands

- If a command or query is unrecognized it is echoed back out the port it came in on.
- All commands and queries are terminated with a Line Feed character.
- A Line Feed character is indicated by <LF> in subsequent command and query definitions.
- All queries can be sent when the Keylock switch is in the INHIBIT, LOCAL, or REMOTE position.
- All commands can only be sent when the Keylock switch is in the REMOTE position.
- All spaces in command and query definitions are indicated by <space>.
- If a query is recognized, its associated response is echoed out the port it came in on.

A COMMUNICATIONS_ERROR<LF> can occur if the time between commands or queries is too short, or the internal RS-485 link between the IO Board assembly and the Multipurpose Board (MPB) assembly is broken.

The development of application programs requires an understanding of the operation of the Model 1200A225 as well as the intended application.

An application program on the computer/controller should issue only one character string (command or query) at a time. After each functional command is issued, the Model 1200A225's status should be checked to ensure that the command has been properly executed. The application program should allow sufficient time for the function to be completed before checking the status.

The application program should facilitate the checking of the status just prior to issuing a command, since the status could have been changed by a fault condition or by operator actions.

Variables represented by wild card characters i.e. x, y, z etc. do not indicate or delimit the number of characters actually specified.

Table 2-4. Relationship between the Model 1200A225 Controls and Remote Communication

AC Power and Circuit Breaker		Power		Keylock Switch			Remote Communication	
On	Off	On	Off	INHIBIT	LOCAL	REMOTE	Command	Query
	√						X	X
√			√			√	√	√
√		√				√	√	√
√		√			√		X	√
√		√		√			X	√
√			√		√		X	√
√			√	√			X	√

X = No, √ = Yes

2.4.2.6.1 Power On/Off

This command controls the power on/off state of the Model 1200A225.

Syntax: **POWER:x**

Parameters: State(x):
OFF = power off
ON = power on

Response Format: None (No query for this command)

Example: To turn the power on, send the following command:
POWER:ON<LF>
 To turn the power off, send the following command:
POWER:OFF<LF>

2.4.2.6.2 RF On/Off

This command controls the RF on/off state of the Model 1200A225.

Syntax: **RF:x**

Parameters: State(x):
OFF = power off
ON = power on

Response Format: None (No query for this command)

Example: To turn the RF on, send the following command:
RF:ON<LF>
 To turn the RF off, send the following command:
RF:OFF<LF>

2.4.2.6.3 Reset Faults

This will clear all faults, if possible.

Syntax: **RESET**

Parameters: None

Response Format: None (No query for this command)

Example: To clear any faults, send the following command:
RESET<LF>

2.4.2.6.4 Mode Select

This command sets the ALC mode of the Model 1200A225.

Syntax: **MODE:x**

Parameters: Mode(x):
MANUAL = Set to Manual/CW mode
ALC<space>INT = Set to ALC Internal mode

Response Format: None (No query for this command)

Example: To set the ALC mode to Manual/CW mode, send the following command:
MODE:MANUAL<LF>

2.4.2.6.5 Level Adjust

This command sets the RF gain, detector gain, ALC threshold, and ALC Response Time of the Model 1200A225.

Syntax: **LEVEL:xy**

Parameters: Parameter(x):
GAIN = RF Gain
DET = Detector Gain
THR = ALC Threshold
RESP = Response Time
Value(y):
For RF Gain, Detector Gain, and ALC Threshold:
0 = Minimum
100 = Maximum
For Response Time:
1 = Minimum
7 = Maximum

Response Format: None (No query for this command)

Example: To set the RF Gain to minimum, send the following command:

LEVEL:GAIN0<LF>

To set the RF Gain to 50%, send the following command:

LEVEL:GAIN50<LF>

To set the ALC Response Time to max, send the following command:

LEVEL:RESP7<LF>

2.4.2.6.6 Identity

Query to identify the Model 1200A225.

Syntax: ***IDN?**

Parameters: None

Query only (always requires a ? character)

Response Format: **f,m,n,<LF>**

Where:

f = manufacturer

m = model designation

n = firmware revision

Example: To get the identity of the Model 1200A225, send the following command:

***IDN?<LF>**

Response: **AR-RF/MICROWAVE-INST,1200A225,1.0<LF>**

2.4.2.6.7 IO Board Firmware Revision

Query to get the firmware revision of the I/O Board.

Syntax: ***IOB?**

Parameters: None

Query only (always requires a ? character)

Response Format: **INTERFACE_BOARD_SW_REVx<LF>**

Where:

x = firmware revision

Example: To get the firmware rev. of the I/O Board, send the following command:

***IOB?<LF>**

Response: **INTERFACE_BOARD_SW_REV3.20<LF>**

2.4.2.6.8 Machine State

This query reads the RF gain, detector gain, ALC threshold, and ALC response time of the Model 1200A225.

Syntax: **MSB?**

Parameters: None

Query only (always requires a ? character)

Response Format: **RF<space>GAIN=x,
DT<space>GAIN=x,
THRES=x,
RESP=y<LF>**

Value(x): [x is always 3 characters in length, padded with leading spaces]

For RF Gain, Detector Gain, and ALC Threshold:

- 0** = Minimum
- 100** = Maximum

Value(y): [y is always 1 character in length]

For Response Time:

- 1** = Minimum
- 7** = Maximum

Table 2-5. Machine State Response Time

Response Time Setting	Time (mS)
1	5
2	10
3	30
4	100
5	1000
6	3000
7	3000

Example: To get the machine state, send the following command:

MSB?<LF>

Response: **RF<space>GAIN=100,DT<space>GAIN=<space>50,THRES=<space>75,RESP=1<LF>**

(RF gain is 100%, Detector Gain is 50%, ALC Threshold is 75%, and ALC Response Time is set to 5mS)

2.4.2.6.9 State

Query to find the state of the Model 1200A225.

Syntax: **STATE?**

Parameters: None

Response Format: **STATE=<space>xyza<LF>**

Where: **x**, **y**, **z**, and **a** are each an ASCII character representing a hexadecimal character. They can be 0 to 9 or A to F.

Each hexadecimal character represents a 4-bit binary number. This 4-bit number is a bit pattern which contains information about the state of the Model 1200A225. The definitions of these bit positions can be found in the table below.

NOTE: Bits labeled NOT USED may be read as a bit state of 1 or 0

**Table 2-6. Bit Position
BIT STATE**

BIT POSITION	BIT DESCRIPTION	0	1	NOTES:	
x	0	PULSE STATUS	OFF	PULSE	
	1	(NOT USED)			
	2	(NOT USED)			
	3	REMOTE CONTROL	DISABLED	ENABLED	Response to key-switch position
y	0	POWER STATUS	OFF	POWER ON	
	1	STANDBY STATUS	OFF	STANDBY	Also known as RF OFF
	2	OPERATE STATUS	OFF	OPERATE	Also known as RF ON
	3	FAULT STATUS	OFF	FAULT EXISTS	
z	0	KEYLOCK INHIBIT	OFF	INHIBITED	Response to key-switch position
	1	ALC ALERT	OK	FOLD BACK	ALC fold back indication
	2	RF AUTO BIASING	INACTIVE	ACTIVE	Biasing state
	3	(NOT USED)			
a	0	MODE MANUAL	DISABLED	ENABLED	Also known as CW MODE
	1	(NOT USED)			
	2	MODE ALC INTERNAL	DISABLED	ENABLED	
	3	(NOT USED)			

Example: To read the state, send the following query.

STATE?<LF>

Response: **STATE=<space>8301<LF>** (Remote Mode, Power On, RF OFF, and Manual Mode)

2.4.2.6.10 Forward Power

Query to get the forward power.

Syntax: **FPOW?**

Parameters: None

Response Format: **FPOW=x<LF>**

Where:

x = 0 to 99999

Values are corrected and linearized. They can be up to five digits in length. Leading zeros are read as spaces. Units are Watts.

Example: To find out the forward power, send the following query.

FPOW?<LF>

Response: **FPOW=<space><space><space>54<LF>** (*54 Watts of forward power*)

2.4.2.6.11 Reverse Power

Query to get the reverse power.

Syntax: **RPOW?**

Parameters: None

Response Format: **RPOW=x<LF>**

Where:

x = 0 to 99999

Values are corrected and linearized. They can be up to five digits in length. Leading zeros are read as spaces. Units are Watts.

Example: To find out the reverse power, send the following query.

RPOW?<LF>

Response: **RPOW=<space><space><space><space>9<LF>** (*9 Watts of reverse power*)

2.4.2.6.12 RF Gain

Query to get the RF gain.

Syntax: **RFG?**

Parameters: None

Response Format: **RFG=<space>x<LF>**

Where:
x = 0000 to 0100

Example: To find out the RF gain of the Model 1200A225, send the following query:

RFG?<LF>

Response: **RFG=<space>0075<LF>** (75% Gain)

2.4.2.6.13 Faults

Query to find the faults that have occurred with the Model 1200A225.

Syntax: **FSTA?**

Parameters: None

Response Format: **FSTA=<space>xxxx<LF>**

Where:
xxxx = 0000 to 0043 (Hexadecimal)

Table 2-7. Faults

Dec	xxxx	Fault Text	Description	RF State After Fault Reset	
0	0000	N/A	No Fault	N/A	
3	0003	Interlock	Interlock	Off	
5	0005	Thermal A1 Driver	Over Temperature Module A1 (Driver Box)	Off	
14	000E	AC Interlock	AC interlock	Off	
22	0016	Amp A1 Driver	Amplifier Module A1 (Driver Box)	On	
25	0019	485 Error	Internal RS-485 Communication Bus Error	Off	
26	001A	ALC	ALC at max attenuation but output still over limit	On	
			One or more Bias Board Assemblies did not echo back their assigned current value	Off	System
27	001B	Bias Confirm Error			
30	001E	System Error	Fiber-Optic Communication Bus Error	Off	
40	0028	MPA1 A1-UC	Module A1 Under Current	On	
41	0029	MPA1 A2-UC	Module A2 Under Current	On	
44	002C	MPA1 A1-OC	Module A1 Over Current	On	
45	002D	MPA1 A2-OC	Module A2 Over Current	On	
50	0032	MPA1 Coolant Lvl	Coolant Level	Off	
51	0033	MPA1 PS2	Power Supply 2	Off	
58	003A	MPA1 Comb Therm	Combiner Thermal	Off	MPA1
62	003E	MPA1 A1-TH	Module A1 Thermal	Off	
63	003F	MPA1 A2-TH	Module A2 Thermal	Off	
64	0040	MPA1 Flow	Coolant Flow (Driver MPA)	Off	
65	0041	MPA1 485 Error	MPA Internal RS-485 Communication Bus Error	On	
67	0043	MPA1 Coolant Tmp	Coolant Temperature	Off	

Example: To find out what faults have occurred, send the following query.

FSTA?<LF>

Response: **FSTA=<space>0003<LF>** (Interlock Fault)

2.4.2.6.14 Operating Hours (RF On)

Query to get the RF On operating hours.

Syntax: **OH?**

Parameters: None

Response Format: **OH=x<LF>**

Where:

x = 0 to 100000

Units are Hours. Values can be up to six digits in length. Leading zeros are read as spaces.

Example: To find out the RF On operating hours, send the following query.

OH?<LF>

Response: **OH=<space><space><space><space>37<LF>**
(The system has spent 37 Hours in an RF On state)

2.4.2.6.15 Operating Hours (Power On)

Query to get the Power On operating hours.

Syntax: **OHP?**

Parameters: None

Response Format: **OHP=x<LF>**

Where:

x = 0 to 100000

Units are Hours. Values can be up to six digits in length. Leading zeros are read as spaces.

Example: To find out the Power On operating hours, send the following query.

OHP?<LF>

Response: **OHP=<space><space><space>428<LF>**
(The system has spent 428 Hours in a Power On state)

2.4.2.6.16 Initiate MPA Coolant Temperature and Transistor Currents

Command to initiate the process of acquiring the MPA coolant temperature and transistor currents.

Syntax: **MPAn**

Parameters: n

Where n is the two digit MPA number which can only be 01.

Response Format: None (No Query for this command)

Example: To initiate the process of finding out the coolant temperature and transistor currents for MPA 1, send the following command:

MPA01<LF>

2.4.2.6.17 Query MPA Coolant Temperature and Transistor Currents

Query to get the MPA coolant temperature and transistor currents for the MPA that was initiated using the MPA Coolant Temperature and Transistor Current initiation command.

Syntax: **MPA?**

Response Format: **MPAn=t,a1,a2,a3,a4,b1,b2,b3,b4,c1,c2,c3,c4,d1,d2,d3,d4<LF>**

Where:

n is the two digit MPA number which was selected with the Initiate MPA Coolant Temperature and Transistor Currents Command.

If n is 00 then the data in the buffer has already been read and the Initiate MPA Coolant Temperature and Transistor Currents Command must be issued again.

T = 0.0 to 999.0 (temperature of the MPA coolant in Celsius)

a1 to d4 = 0.0 to 99.9 (transistor current in Amps)

a1 to a4 are transistors 1 to 4 of module 1.

B1 to b2 are transistors 1 to 4 of module 2.

C1 to c4 are transistors 1 to 4 of module 3.

D1 to d4 are transistors 1 to 4 of module 4.

Leading zeroes are read as spaces. (Total return string length is 95 characters)

Example: To find out the coolant temperature and transistor currents for MPA 1, send MPA01 and then send the following query.

MPA?<LF>

Response: **MPA01=80.5, 5.4, 5.3, 5.4, 5.4, 5.5, 5.6, 5.4, 5.3, 5.4, 5.3, 5.4, 5.4, 5.5, 5.6, 5.4, 5.3<LF>**

2.4.2.6.18 Remote Operating Timeout

Command to set the period between required communications to maintain an RF On state while in remote mode.

Syntax: **ROPTOx**

Parameters: x = 0 to 500 in seconds

Query: **ROPTO?**

Response Format: **ROPTO=x<LF>**

Example: To set the required period between communications that must be maintained once RF On has been initiated, send the following command.

ROPTO10<LF>

To find out what the period between communications that must be maintained once RF On has been initiated, send the following query.

ROPTO?<LF>

Response: **ROPTO=6<LF>**

2.4.2.6.19 ALC Board Firmware Revision

Query to get the firmware revision of the ALC board assembly.

Syntax: ***ALC?**

Parameters: None
Query only (always requires a ? character)

Response Format: **ALC_SW_REVx<LF>**
Where:
x = firmware revision

Example: To get the firmware rev. of the ALC board assembly, send the following command:
***ALC?<LF>**

Response: **ALC_SW_REV1.60<LF>**

2.4.2.6.20 SBB (Piggyback) Firmware Revision

Query to get the firmware revision of the piggyback SBB assembly.

Syntax: ***SBB?**

Parameters: None
Query only (always requires a ? character)

Response Format: **SBB_SW_REVx<LF>**

Where:

x = firmware revision

Example: To get the firmware rev. of the piggyback SBB assembly, send the following command:

***SBB?<LF>**

Response: **SBB_SW_REV2.70<LF>**

2.4.2.6.21 SBB (Optical) Firmware Revision

Query to get the firmware revisions (groups of twenty) of the SBB assemblies that are fiber-optically connected to the MPB assembly.

Syntax: ***SBBn?**

Parameters: **n** = group number (1 or 2)
Query only (always requires a ? character)

Response Format: **SBB_SW_REVx<LF>**

Where:

x = firmware revision

Example: To get the firmware revisions of the first twenty (20) SBB assemblies, send the following command:

***SBB1?<LF>**

Response: **SBB_SW_REV2.70,2.70,2.70,2.70,2.70,2.70,2.70,2.70,2.70,2.70,2.70,2.70,2.70,2.70,2.70,2.70,2.70,2.70,2.70,2.70<LF>**

2.4.2.6.22 System Serial Number

Query to get the serial number of the system.

Syntax: SN?

Parameters: None
Query only (always requires a ? character)

Response Format: x<LF>
Where:
x = serial number (6 to 8 characters)

Example: To get the serial number, send the following command:
SN?<LF>

Response: 1234567<LF>

2.4.2.6.23 AC Power-On Defaults

Default settings that are applied at AC mains power-on can be changed by adding the following prefix to select commands.

Syntax: DEFAULT:

Compatible commands:

Level Adjust

LEVEL:GAIN	
LEVEL:DET	(Not available on all models)
LEVEL:THR	(Not available on all models)
LEVEL:RESP	(Not available on all models)

Mode Select

MODE:MANUAL	(Not available on all models)
MODE:PULSE	(Not available on all models)
MODE:ALC<space>INT	(Not available on all models)
MODE:ALC<space>EXT	(Not available on all models)

NOTES:

1. Use the command **DEFAULT:FACTORY** to reset all applicable settings back to their factory defaults.
2. All applicable defaults can be queried, except **DEFAULT:FACTORY**, by adding a ? character in place of the setting parameter.
3. If the ALC Lockout Feature (not available on all models) is engaged, the default ALC values set with this command will not be used.

Example 1: To set the default RF Gain to 75%, send the following command:
DEFAULT:LEVEL:GAIN75<LF>

Example 2: To query the default RF Gain setting, send the following command:

DEFAULT:LEVEL:GAIN?<LF>

Response: **DEFAULT:LEVEL:GAIN75<LF>**

Example 3: To set the default mode to manual, send the following command:

DEFAULT:MODE:MANUAL<LF>

2.4.2.7 Interlocks

The Model 1200A225 has two separate interlock circuits that are wired to the rear panel Safety Interlock connector. Both interlocks require normally closed external circuits to allow the amplifier to function.

2.4.2.7.1 Inhibit Interlock

For interlock applications where the amplifier is not required to shut down completely (AC Off), this interlock circuit inhibits RF amplification by disabling the low-level amplifier stages and forcing the amplifier into the Standby (RF OFF) condition.

The Inhibit Interlock is wired to the rear panel interlock connector pins 1 and 8. A closed circuit from interlock connector pin 1 to pin 8 is required for normal operation. Opening the Inhibit Interlock connection will inhibit the amplifier and display **Interlock** on the front panel.

When the Inhibit Interlock circuit is restored to a closed condition, the Inhibit Interlock fault can be cleared by pressing the **RESET** button on the touch screen or by using the RESET remote command (when the Keylock Switch is set to **REMOTE**). After the Inhibit Interlock fault is cleared, the RF ON command must be re-asserted to return to an RF ON condition.

2.4.2.7.2 AC Interlock

For interlock applications that are more safety critical, where logic circuits are not trusted, the AC Interlock can be used to disconnect the major amplifier circuits from the AC mains.

The AC Interlock is wired to the rear panel interlock connector pins 10 and 14. This interlock circuit is connected directly in series with the AC relay circuit. There are no logic circuits or transistors in this signal path. A closed circuit from interlock connector pin 10 to pin 14 is required for normal operation. Opening the AC Interlock connection will disconnect AC primary power to all MPAs and display **AC Interlock** on the front panel.

When the AC Interlock circuit is restored to a closed condition, the AC Interlock fault can be cleared by pressing the **RESET** button on the touch screen or by using the RESET remote command (when the Keylock Switch is set to **REMOTE**). After the AC Interlock fault is cleared, the RF ON command must be re-asserted to return to an RF ON condition.

2.5 RF OUTPUT

The output of the Model 1200A225 is provided through a male 7-16 DIN Female RF connector located on the rear of the unit.

2.6 ELECTRICAL POWER

There is one power connection for the Model 1200A225. It requires a single-phase, 200–240 VAC connection (50/60 Hz, 4.6kW maximum).

3. THEORY OF OPERATION

3.1 GENERAL

The Model 1200A225 amplifier can be a relatively simple unit to understand. The amplifier chain is a straightforward design, with a few control elements in the lineup. The unit's power supply, control and fault detection circuits can be easily understood by anyone with a minimal understanding of analog and digital circuitry.

3.2 AMPLIFIER

Refer to Interconnect Diagram 10044018, Driver Schematic 10044183 and the schematics referred to below.

3.2.1 Amplifier RF Input

The RF Input connector is a Type N female which can be located on the front or rear panel of the amplifier depending on configuration selected.

3.2.2 A1 RF Module

Located in the Driver Assembly, the A1 RF Module consists of RF matching circuits, four stages of RF amplification, DC current control circuitry, and a temperature and current fault detection circuit.

The RF input is fed to a variable attenuator circuit (Q1-Q4) used for amplifier gain control and input level overdrive protection. The signal is then fed through 3 stages of amplification (Q6, Q7, Q8) with approximately 33 dB of gain. The final push pull stage (Q9) is coupled through balun transformers on both input and output. The push pull stage has a gain of approximately 19 dB. Each amplifier stage has a drain voltage of 28V and the drain current for the entire module is approximately 4A. The module has an output compression point of 25W or greater.

The current through Q9 is monitored by U8. The output of U8 is fed to an op amp (U10). U10 has a reference voltage on the non-inverting input which represents the maximum allowable drain current. U10 reacts when the output of U8 is surpasses this reference voltage which reduces the gate voltage of Q9 in order to limit the drain current. Op amp, U11, is used to set the quiescent bias of the transistor.

U9 and associated circuitry provides fault detection for both Q9 drain current and module temperature. The output of U8 is monitored by U9 and it will signal a fault if the drain current of Q9 exceeds safe operating limits. Similarly, a thermistor (RT1) senses the temperature of the heatsink and U9 will also signal a fault if the module temperature exceeds safe operating limits.

3.2.3 Driver Power Supplies (PS1, PS2)

Power supply PS1 supplies a +5VDC housekeeping supply for the control system assemblies A5A1 Control and A5A3 Switch Breakout Boards.

PS1 also supplies +15 VDC at 2.5 amps and -15 VDC at 1 amp. PS1 is a switching supply that automatically sets the AC input circuits to the correct connections for the line voltage 90-264 VAC input ranges 47-440 Hz.

The -15 V at 1 amp power supply is fed to the A1 RF module to provide gate voltage for this module.

Power Supply PS2 is a single output supply which provides +28VDC to the RF final stage and to the A10 Voltage Regulator board. Primary AC circuit protection is provided by the circuit breaker in the Power Entry Module.

3.2.4 A5 Control/Fault Board (Schematic #10030013)

The A5 Control/Fault boards consists of one 16-bit microcontrollers and several other ICs that monitor and indicate the status of the amplifier. Power is supplied using only a single 5-volt power supply. The board offers the following:

Feature	Quantity
Open drain outputs	4
Digital outputs	6
Digital inputs (5-volt tolerant)	24
Analog outputs	2
2-channel encoder input	1
Inputs for a keypad	6
Display connectors	1
Serial communication jacks	2

3.2.5 A10 Voltage Regulator Board

The A10 Voltage Regulator Board contains two adjustable positive voltage circuits employing Linear Regulator ICs U4 and U5. U4 accepts a +28 VDC input and outputs the +24.0 VDC Drain Voltage for the A1 preamp stage. U5 accepts a +28 VDC input and outputs the +24.0 VDC supply voltage for the B1 Fan Assembly.

3.2.6 Splitter, Attenuator

The output of the A1 Driver module is then connected to a 2-way splitter. The two outputs from the splitter are of equal gain and phas, each to feed one of two inputs to the main power amplifier unit.

3.2.7 Main Power Amplifier Unit (MPA)

One MPA unit provides the rated output power. Refer to Schematic 10044034. The MPA consists of two liquid-cooled power amplifier modules (A1-A2), power supplies, and a cooling system. The cooling system, including a pump, heat exchanger, and a cooling fan, circulates a mixture of water and propylene-glycol coolant through the amplifier modules. Each of the amplifier modules has a gain of approximately 21 dB, and each has its output fed to the front panel connectors of the MPA. The total output of the four modules in combination is sufficient to meet the specified output power of the 1200A225. Primary power to the MPA is from the AC power distribution unit. It is switched by the breaker on the MPA rear panel, as well as the contactor internal to the MPA which is controlled from the driver/control unit. Fault detection signals are gathered from the four modules by the switch breakout board A5 and fed to the driver/control unit. Control signals from the driver/control unit are fed to A5 and distributed to the four amplifier modules.

3.2.8 Liquid-Cooled Module

The Liquid-cooled module (schematic 10038146) consists of two pair of push-pull transistors, for a total of four transistors (Q1-Q4). The transistors are mounted on a copper plate through which liquid coolant is circulated. Transistor bias is set and controlled by the automatic bias board which plugs into the module. The bias levels and fault detection levels (over-current, under-current, and current limit) for each transistor are factory-programmed into the bias board, and set to correct levels each time DC power is applied to the amplifier. Current through each RF transistor is monitored by hall-effect sensors U1-U4 (corresponding to Q1-Q4). The output signal of each hall-effect sensor is fed to the bias board through J1; the bias board applies the appropriate bias voltage to each transistor based on its current as read by the sensors. The bias board also reports faults to the control panel through the transmit board as described in the previous section. Each bias board (one per module) also has four LED's corresponding to each transistor to aid in fault location. Thermal switch SW1 senses over-temperature locally and 1) sends a signal to the control panel to shut down the amplifier and 2) as a failsafe and backup to the control panel, disconnects the +5V supply from the bias circuitry. Power combination from the four transistor stages is achieved through a series of balun transformers in the output section.

3.2.9 Output Combiner/Directional Coupler, Detector Assembly

The outputs from the amplifier modules in the MPA are combined into one output in the output combiner. The combiner operates in a zero-degree configuration. The combiner is designed to tolerate loss of input signals at full output power. The single output then passes through a dual directional coupler, located next to the combiner assembly, the output of which is routed to the main output connector of the amplifier, a 7/16 DIN female connector. The forward and reflected ports of the directional coupler are at a level of about -50 dB relative to the main output signal. The RF detectors for converting the amplifier's Forward and Reflected RF signals to usable DC signals are located in the driver/control unit. The detected signals are used by the ALC, fault detection/control circuits and by the Forward and Reflected power display on the Digital Control Panel (DCP).

Inside the detector assembly (Schematic 10025119), a combination of attenuators and MMIC amplifiers process the signal to feed the output the sample signal to the front panel sample ports. Active detectors are used to provide DC signals to the ALC board for amplifier control and also to provide the analog signal to the control panel providing the power level readings on the display.

3.2.10 Sample Ports

Sample port functionality can be purchased as an option. The sample ports are measured during final alignment of the amplifier, and a correction table is provided with enough measured points to adequately characterize the sample ports across the full bandwidth of the amplifier.

3.3 POWER SUPPLY

Refer to Interconnect Diagram Number 10044018. Main power to the unit is supplied by single phase AC power within the proper range. In series with the line voltage is the **Main circuit breaker**, located on the rear panel. This circuit breaker supplies AC line voltage to the power distribution box. The driver/control unit and the main power amplifier unit are fed from outlets in the power distribution box. The Driver/control unit and the MPA each have internal AC contactors. The contactors are controlled by the front panel Power ON/Off switch and interrupted manually by the three-position key-switch labeled **Inhibit – Local – Remote**. The contactors feed AC directly to the primary inputs of the main power supplies. When the main circuit breaker

is on, AC power is fed to the low level/bias supply PS1 in the driver/control unit. Therefore, when the circuit breaker is turned on, the control panel and basic low-power supplies are alive, and the amplifier is armed for Power On. At this time, the front panel display is illuminated and the control circuitry is active.

3.4 CONTROL CIRCUITS

3.4.1 Fiber-Optic System Control Link

The 1200A225 control system uses a fiber-optic communication system to link each of the MPA's back to the Driver/Controller unit. The Digital Control Panel (DCP) uses this link to send information to the system MPA's and read fault conditions. Therefore, this link is critical to the operation of the amplifier system. When the system is powered up, the DCP goes through an addressing process in which a communication link is established for each item in the serial chain. If this process fails, a fault condition is generated.

An LED is installed on the rear of each MPA to indicate the state of this link. See Table 3-1 below for the link states. This information is also indicated on a label next to the LED.

Table 3-1. Link States

LED	F/O LINK
OFF	NONE
BLINK	LOCAL
ON	SYSTEM

If the LED is off, then either there is no power to the MPA or the internal Switch Breakout Board (SSB) assembly failed to initialize.

If the LED is blinking, it means that locally the MPA is powered and the SBB is initialized.

If the LED is on solid, the communications link has been established with the DCP.

For the amplifier to be able to go to an RF on state, all MPA link LED's must be on solid.

3.4.2 Power On/Operate Circuits

This section describes the functioning of the switches, relays and controls in the AC/DC power distribution system. See Interconnect Diagram, 1200A225, Schematic 10044018 and Interconnect, Driver Amp 10044183.

There are six AC circuit breakers: the main circuit breaker and branch circuit breakers on the rear of the amplifier, one on the rear panel of the Driver/Control Unit (DCU) and one on the front panel of the MPA. The main circuit breaker disconnects all circuits from the AC mains. The following description assumes that the main breaker is closed, making AC power available to the amplifier components. In the DCU, +5VDC and +15VDC from PS1 are connected to the digital control panel and the ALC board whenever CB main on the DCU rear panel is closed.

Relay K1, in the DCU, controls AC power to the main power supply in the MPA for amplifier operation. K1 controls the AC contactor in the MPA, which applies AC power to MPA PS2, the main power supply to the MPA modules. Control for relay K1 loops through the interlock connector P9/J1 to the control panel. The relay has +15V applied to their coils, and a "low" signal from the control panel to the other side of the coils sinks current, activating the relays.

Note that in order to complete the circuit through K1, the external AC interlock circuit must be closed. The I/O panel Safety Interlock connector provides pins 10 and 14 for this purpose. Another interlock circuit, provided in the same connector, is used for RF inhibit, pins 1 and 8, if the user so desires. Both types can be used simultaneously in their respective circuits. If the AC interlock circuit is open, a direct logic signal will be applied to the Control Panel to display **AC Interlock** on the display when Power On is attempted. If the Inhibit interlock is open, **Interlock** will be displayed.

The energized relay K1 will energize the MPA contactor, applying the AC mains to the MPA main power supply. The unit will then be in the STANDBY (RF Off) condition. In this state, all RF Power stages in the DCU and the MPA are without DC power, making it impossible to produce any RF power. Power supply and main cooling fans will be heard even though no DC is output from the main power supply. The DC output power from the main power supply (PS2 in the MPA) when AC is supplied, is toggled on and off by the **RF ON** and **RF OFF** function.

Note that upon selecting **RF ON** there is a delay of a few seconds for the Test Rack/MPA to produce output. This time is required for stabilization and confirmation of proper bias current levels to each transistor in the system.

If the Keylock Switch is in the REMOTE position, the Power and Operate functions are the same except that they can only be performed remotely (i.e., from the user's computer), since the front panel controls are locked out when the amplifier is in the Remote mode.

3.4.3 Automatic Level Control Circuits

This section describes the operation of the Automatic Level Control (ALC) circuit board. Refer to schematic diagram number 10023927, **Schematic, Digital ALC Board**.

The ALC board performs the following general functions:

- It limits the RF drive level to the amplifier stages and sounds an audible alarm when the amplifier's Forward or Reflected power levels try to exceed preset levels.
- It sends a fault signal to the Digital Control Panel (DCP) if the limiting previously described fails to control the amplifier's Forward or Reflected power levels. This fault signal ultimately inhibits the amplifier.
- Allows the user the means to level at a set output power level.

3.5 FAULT DETECTION CIRCUITS

This section describes the function and theory of the Model 1200A225's fault detection circuits.

The driver power module A1 is monitored for over-temp fault using a thermal switch. In the event of an over-temp, the PS2 power supply will be shut down so no DC is supplied to the A1 module.

The driver power module is also monitored for current faults. In the event of an over-current (OC) or under-current (UC), the gain inhibit line to the module will be inhibited but the PS2 power supply will be active so troubleshooting is possible.

Faults from the MPA's are transmitted to the DCP by the Switch Breakout Board (SBB), A6 in the MPA. The SBB assembly processes fault information from all four RF amplifier modules within the MPA. The faulty module location is displayed, and a red LED indicator lights on the module at fault. There are four LED indicators on each bias board, one for each power transistor.

Note that after a fault condition has been invoked, the circuit breaker and DCU circuit breakers must be left on to keep the temporary memory active, until all faults can be manually recorded for diagnostic purposes. Faults may be recorded by the host system if the host software is written to respond to fault conditions. Fault conditions may be queried at any time during normal operation of the 1200A225.

Detected fault signals are recorded in temporary (volatile) memory before the amplifier control circuits act to protect the amplifier, sometimes resulting in RF inhibit or shut down. In some cases, inputs are read multiple times to prevent a transient signal from causing an unwarranted action. Note that after a fault condition has been invoked, the circuit breaker CB1 must be left on to keep the temporary memory active, so that all faults can be manually recorded for diagnostic purposes. Faults may be recorded by the host system if the host software is written to respond to fault conditions. Fault conditions may be queried at any time during normal operation of the amplifier.

3.5.1 Thermal Faults

Each of the 500 watt modules in the MPA contains thermal sensor switches. In the case of a thermal fault, the line will go high. The control panel displays the module designator and **TH**, and the main power supplies will be inhibited to allow the modules to cool down.

3.5.2 Current Faults

Refer to schematic diagram 10038146, **500 Watt Module**. There are two possible faults that will signal the control system. They are Over-current (OC), Under-current (UC) faults.

3.5.2.1 Over-current

On each 500 watt module, a current-sensing IC delivers an output voltage which is proportional to the current being drawn. This voltage is compared to an adjustable reference voltage by an op-amp. If the output voltage exceeds the reference voltage, the op amp's output goes high to indicate that too much current is being drawn. This causes the control panel to display the module designator and **OC**, as well as inhibiting the main power supplies.

3.5.2.2 Under-current

Each 500 watt module has an op-amp which compares the current sense output voltage to an adjustable reference voltage such that it detects an undercurrent condition. If the output voltage drops below the reference voltage, the op amp's output goes high to indicate that too little current is being drawn. This causes the control panel to display the module designator and **UC**, as well as inhibiting the RF signal.

3.5.3 Power Supply Faults

The main power supplies in the DCU and MPA's are monitored internally. If a supply fails to produce DC voltage within its specification, a logic signal will signal the fault board, resulting in an instant shut down. The power supply faults and inhibit signals are routed to the Control Panel. The fault signal is a logic high (+5VDC) when all is well, switching to a logic low if a fault occurs.

3.5.4 ALC Fault

An ALC fault is invoked whenever the forward or reverse power limit controls do not function, causing the RF power to exceed one of the preset limits. The ALC fault is a logic low when invoked. The logic low from the ALC board signals the digital control panel, which, in turn, disables the RF output by inhibiting the main supply, PS1.

3.5.5 Interlocks

The Model 1200A225 Driver has two interlocks that are wired to the rear panel Safety Interlock connector. The interlocks are separate circuits. Both interlocks require normally closed external circuits to allow the amplifier to function.

3.5.5.1 Inhibit Interlock

For interlock applications where the amplifier is not required to shut down totally (AC Off), this interlock circuit inhibits RF amplification by disabling the preamp in the DCU and power supplies and forcing the amplifier into the Standby (RF Off) condition. The inhibit interlock is wired to the rear panel Interlock connector pins 1 and 8. A closed circuit from Interlock connector pin 1 to pin 8 is required for normal operation. Opening the connection will inhibit the Driver and display **Interlock** on the front panel. When the inhibit interlock has been opened, the Driver returns to the Standby (RF Off) condition, forcing the re-assertion of the Operate (RF On) command returns the unit to normal operation.

3.5.5.2 AC Interlock

For interlock applications where it is desired to disconnect the AC power source from the main power supplies, the AC interlock can be used to disconnect the amplifier from the AC mains. This interlock circuit is connected directly in series with the relay coils K1 and K2 in the DCU, which actuate the contactors for the main power supplies in the DCU and MPA. Rear panel Interlock connector Pins 10 and 14 are for this purpose. Pin 10 provides the activation signal from the control panel P2-2 to the relay coils. Opening the AC interlock connection will disconnect AC primary power to all major circuits and display **AC Interlock** on the front panel.

Fault conditions can be reset by pressing the **RESET** button displayed on the Touch Screen located on the front panel or by sending the RESET remote command from the user's computer (when the Keylock Switch

is set to **REMOTE**). Either of these conditions causes the 1200A225's DCU to return to normal conditions. Forcing the user to reassert the Operate command (RF On) after a fault or interlock condition is a safety feature that prevents an unexpected burst of RF when the fault or interlock condition has been restored. Fault conditions that require the MPA to be disconnected from the AC mains will be reset automatically upon re-energizing the amplifier. Only fault conditions that continue to be valid will be displayed after the AC mains have been disconnect via the circuit breaker or external disconnection.

3.5.6 System Error (F/O Link Fault)

The fiber-optic serial link must be established before the amplifier system can go to an RF On state. This link is established immediately upon power on of the driver box. It is for this reason that all sub-amplifier breakers must be powered on before the driver rack is powered on. If the link fails to be established with all MPA's, a fault condition is generated. The LED's on the rear of each MPA can be used to determine where the link is broken.

4. TROUBLESHOOTING AND REPAIR

4.1. GENERAL

Because it is a relatively simple instrument, the Model 1200A225 should require very little maintenance. It is built with solid state devices and printed wiring boards (PWBs) that should ensure long, trouble-free life. Should trouble occur, special care must be taken when servicing the unit to avoid damaging the solid state devices and PWBs.

Since the amplifier's components are soldered in place, substitution of components should not be resorted to unless there is some indication that they are faulty. In addition, care must be taken not to short voltages across the amplifier when troubleshooting, because small bias changes may damage the amplifier due to excessive dissipation or transients.

Components used in Amplifier Research instruments are conservatively operated to provide maximum instrument reliability. In spite of this, parts may fail. Usually, the instrument must be immediately repaired with a minimum of down time. A systematic approach can greatly simplify and thereby speed up repairs. The Model 1200A225 incorporates fault control and detection circuits, including display panel indications that can expedite troubleshooting of the unit. For a description of how these indications can be used to assist in troubleshooting the unit, please see section 4.3, **Fault Signal Interpretation and Diagnosis**.

To return an item, contact AR Customer Service for an RMA number and shipping instructions. Returns from outside the United States are not permitted without prior authorization. If shipping from outside of the United States, closely follow all directions on the RMA form for return shipping and marking. See warranty statement at rear of manual.

4.3 FAULT SIGNAL INTERPRETATION AND DIAGNOSIS



CAUTION:

Extreme caution should be exercised when troubleshooting this unit, particularly when measuring voltages in the power supply section, as hazardous voltages exist in the unit that could cause serious injury to personnel performing such measurements.

4.3.1 General - Reading Faults

The Model 1200A225 incorporates relatively simple fault detection circuitry, which makes use of the digital display panel to alert the user or technician which component(s) need service. Use of these indications can usually expedite troubleshooting of the amplifier. Most faults can be immediately determined down to the assembly level. If a reset is still indicated, turn off the RF power signal to the input of the amplifier, read and record the fault indication displayed on the digital control panel for later reference. Then, use the RESET function to see if the fault clears. If the fault clears, slowly bring the amplifier's drive level back up and ensure that recommended RF power levels are not exceeded. If the fault indication is no longer visible, the fault may have been brought about by a temporary transient condition, component thermal condition or excessive RF drive to the amplifier's input. If the fault does not clear with the RF drive off, some other problem exists in the amplifier.

4.3.2 Power Supply Faults

Indication – PS2

The main power supply has failed to produce DC voltage within the design range of the power supply. The main power supply PS2 is located on the bottom shelf of the MPA.

4.3.3 Thermal Faults

RF module thermal faults are detected. See section 4.3.5. The liquid coolant temperature is monitored and will trigger a thermal fault if it overheats.

4.3.4 ALC Fault

Indication – ALC

As stated previously, the power limit controls could not limit either the forward or reverse power to the preset threshold. This can be a transient type of problem, if the fault can be cleared. If the fault cannot be cleared with no RF input drive power, then there is a malfunction in the ALC board or associated circuit.

4.3.5 RF Module Faults

Any RF module fault will trigger amplifier shut down, including main power supplies. There are three possible module faults – Over-current, Under-current and Thermal. Module faults are displayed as **OC?**, **UC?** or **THERM?**, where OC=Over-Current, UC=Under-Current and THERM=Thermal. ? locates the defective module within the MPA or DCU. ?= location number, explained in section 4.4.1.

Thermal faults usually indicate ambient temperature is too high, there is inadequate air-flow through the module heat sinks or there is a problem with the sensor in the module.

Over-current faults usually indicate there is a short circuit that would not clear on the module printed wiring or component, or the module current limit is not adjusted correctly. Under-current faults usually indicate that one of the output devices is defective and/or not drawing enough current.

CAUTION:



The MPA unit's housing is specially designed to route cooling air over the modules' components. Operation with any covers removed should be limited to one-(1) minute intervals with a two (2) minute cool down, especially at frequencies above 100MHz.

4.3.6 Fault Troubleshooting Guide

Driver		
Fault	Type of Fault	Possible Reasons
Therm driver	Thermal	Driver fan blocked or clogged, PS2 has no output
UC driver A3	Under Current	Driver FET is damaged and drawing no current, Gate voltage is being pulled down
OC driver A3	Over Current	Driver FET had been over driven. Usually resettable and cured by backing off input drive
PS3 driver	Power Supply	PS3 has failed
ALC	leveling	ALC circuit is not working and allowing the RF power to exceed a preset limit
MPA		
Fault	Type of Fault	Possible Reasons
485 MPA1 (A1-A2,A6)	Communication	Incorrect address setting on module bias boards or transmit bd, damaged transmit or bias bd
Therm MPA1 (A1-A2)	Thermal	Coolant line disconnected, blockage of coolant flow through module listed
UC MPA1 (A1-A2)	Under Current	Final module FET is damaged and drawing no current, insufficient gate voltage to FET
OC MPA1 (A1-A2)	Over Current	Final module FET had been over driven. Usually resettable and cured by reducing input drive
PS1 Final MPA1	Power Supply	PS1 has failed inside MPA 1
PS2 Final MPA1	Power Supply	PS2 has failed inside MPA 1
Coolant level MPA1	Coolant	Radiator is low and needs coolant added.
Flow MPA1	Coolant	Flow is blocked, Sensor is defective
Thermal MPA1	Thermal	Radiator fan has stopped, PS1 is defective

**NOTES: Driver A1 refers to the driver module within the driver assembly
 (A1-A2) refers to the power modules within the MPA assembly
 A6 refers to the transmit board assembly*

4.4 DIAGNOSING AND REPLACING AMPLIFIER MODULES

4.4.1 Locating Modules

See Figure 4-1.

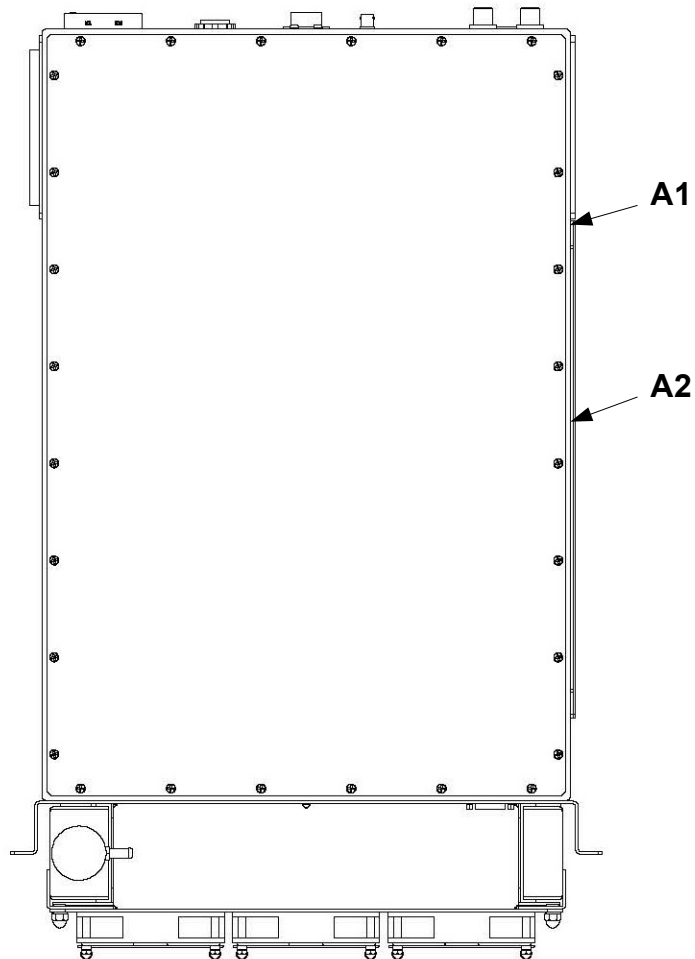

Figure 4-1. 1200A225 MPA/Module Locations (Rear View)

4.4.2 Module Replacement

If, after troubleshooting, it has been determined that one of the Liquid-cooled modules has failed, the following procedure should be followed if a spare module for the unit is available.



CAUTION:

Power to the unit must be turned off before performing any repair work; this should be done by unplugging the unit from the line voltage source. Failure to disconnect the unit from the line voltage source prior to servicing would present a hazard to service personnel and could result in damage to the amplifier.

Before pulling out the MPA, MPA-retaining hardware must be removed. Removal from the cabinet requires the removal of a mechanical stop. Also, cables and connectors must be disconnected. Side panels or the top panels may need to be removed. Providing that the filler caps for the liquid coolant are left in place, the unit may be turned on its side or on its top for service.

After cover removal, the signal connector, the two heavy DC power supply connectors and the RF input and output connectors can be disconnected from the module being serviced. The liquid coolant connectors will not spill coolant and may be disconnected along with the other connections. Take note of any connector that is found loose. To remove the module, remove the six screws that hold the module into the frame and gently lift the module out. The module is relatively heavy with its copper cold plate. Be careful not to damage wires or RF cables, and not to hold the module by its magnetic cores, during the removal process. Be especially careful with SMT components that may be located along the edge of the PWB.

A module is installed in the reverse order, making sure that all connections are tight. Use an appropriate open-end wrench to tighten the SMA RF connector.

4.4.3 Cooling System

The liquid cooling system is a closed system which will operate for years without maintenance. The coolant level should extend into the coolant reservoir, with the heat exchanger full for optimum cooling. The coolant is a mixture of 50% Noburst AL propylene-glycol anti-freeze and 50% distilled water. This will provide protection to 5° F (-15° C) for operation and -20 ° F (-29° C) for storage. Quick-disconnect leak-proof connectors are incorporated to allow removal of modules and major system components with no leakage of fluid. If coolant is removed from the system for any reason, the pump should not be activated; damage to the pump can occur if it is run without fluid.



CAUTION:

EYE AND SKIN IRRITANT

Contains propylene glycol. Do not swallow. Do not allow eye contact or prolonged skin contact. For additional information, refer to Material Safety Data Sheet.

Appendix A. Installing Software Upgrades

A.1 FIRMWARE UPDATES

Most digital assemblies within the 1200A225 control system have the ability to have their firmware updated by the end user. Some of these assemblies require hardware re-configuration while others do not. All firmware updates have some risk associated with them. It is for this reason that all firmware updates should be discussed with the AR Customer Service department before being performed.

All firmware updates will require a PC and a standard USB peripheral device cable (A-B connectors). It is recommended that the PC be 64-bit running Windows 7 or Windows 8 64-bit.

1. Download the AR Firmware Upgrade Utility from the AR website. There are two versions available for download. One version is for 32-bit operating systems and one version is for 64-bit operating systems. Select the appropriate version and download it to the PC that will be used to perform firmware updates.
2. Un-zip the Firmware Upgrade Utility file that was downloaded and run the installer executable. This will install the AR Firmware Upgrade Utility on the PC.

The following are assemblies that can be updated using the AR Firmware Upgrade Utility. Since updates for these assemblies are slightly different from one another each of their associated processes are listed separately. All of these updates can be performed in any order unless otherwise instructed by the AR Customer Service Department.

A.2 CONTROL - MULTI-PURPOSE BOARD ASSEMBLY FIRMWARE (X1)

1. Power off the entire 1200A225 system.
2. Go to the AR website and download the firmware file for the Model 1200A225.
3. Once the download completes, unzip the firmware file on the PC that will be used to perform the firmware update. Do not change the names of the folder or files that are unzipped.
4. Run the AR Firmware Upgrade Utility and follow the instructions it provides.
5. Once the utility successfully connects to the 1200A225 Driver Box, click the Update button for the Control firmware. The utility will step through an additional setup process similar to the one that was previously done. Follow these instructions exactly. When asked to power on the device, only power on the Driver Box.
6. When the utility confirms that the 1200A225 is in the correct state, it will prompt for the model specific firmware file which was unzipped in the steps above. Select this file and allow the utility to complete the update process.
7. After the update is complete, cycle power to the entire 1200A225 system.

A.3 I/O - INPUT OUTPUT BOARD ASSEMBLY FIRMWARE (X1)

1. Power off the entire 1200A225 system.
2. Go to the AR website and download the IO firmware.
3. Once the download completes, unzip the firmware file on the PC that will be used to perform the firmware update. Do not change the names of the folder or files that are unzipped.
4. Run the AR Firmware Upgrade Utility and follow the instructions it provides. When asked to power on the device, only power on the Driver Box.
5. Once the utility successfully connects to the 1200A225 Driver Box, click the Update button for the I/O firmware.
6. The utility will prompt for the IO firmware file which was unzipped in the steps above. Select this file and allow the utility to complete the update process.
7. After the update is complete, cycle power to the entire 1200A225 system.

A.4 BREAKOUT - PIGGY-BACK CONNECTED SWITCH BREAKOUT BOARD (SBB) ASSEMBLY FIRMWARE (X1)

1. Power off the entire 1200A225 system.
2. Go to the AR website and download the SBB firmware.
3. Once the download completes, unzip the firmware file on the PC that will be used to perform the firmware update. Do not change the names of the folder or files that are unzipped.
4. Run the AR Firmware Upgrade Utility and follow the instructions it provides. When asked to power on the device, only power on the Driver Box.
5. Once the utility successfully connects to the 1200A225 Driver Box, double click the 1200A225 model number in the upper right corner of the utility.
6. Enter the password 2157238181. This will uncover additional update options.
7. Click the Update button for the SBB Piggyback firmware.
8. The utility will prompt for the SBB firmware file which was unzipped in the steps above. Select this file and allow the utility to complete the update process.
9. After the update is complete, cycle power to the entire 1200A225 system.

A.5 BREAKOUT - FIBER-OPTIC CONNECTED SWITCH BREAKOUT BOARD (SBB) ASSEMBLY FIRMWARE IN MPAS (X4)

1. Power off the entire 1200A225 system.
2. Disconnect the TX and RX F/O SYS CONTROL connections from rear panel of the Driver Box.
3. Using a pair of fiber-optic cables, attach the TX and RX connections of the F/O SYS CONTROL found on the rear panel of the Driver Box, to the RX and TX connections on any MPA. (TX to RX and RX to TX).
4. Go to the AR website and download the SBB firmware.
5. Once the download completes, unzip the firmware file on the PC that will be used to perform the firmware update. Do not change the names of the folder or files that are unzipped.
6. Run the AR Firmware Upgrade Utility and follow the instructions it provides.
7. Once the utility successfully connects to the 1200A225, double click the 1200A225 model number in the upper right corner of the utility.
8. Enter the password 2157238181. This will uncover additional update options.
9. Click the Update button for the SBB Optical firmware.
10. The utility will prompt for the SBB firmware file which was unzipped in the steps above. Select this file and allow the utility to complete the update process.
11. After the update is complete, power off the entire 1200A225 system and restore all fiber-optic connections then power on the 1200A225.

A.6 AUTOMATIC LEVELING CONTROL (ALC) ASSEMBLY FIRMWARE (X1)

1. Power off the entire 1200A225 system.
2. Go to the AR website and download the ALC firmware.
3. Once the download completes, unzip the firmware file on the PC that will be used to perform the firmware update. Do not change the names of the folder or files that are unzipped.
4. Run the AR Firmware Upgrade Utility and follow the instructions it provides. When asked to power on the device, only power on the Driver Box.
5. Once the utility successfully connects to the 1200A225 Driver Box, double click the 1200A225 model number in the upper right corner of the utility.
6. Enter the password 2157238181. This will uncover additional update options.
7. Click the Update button for the ALC firmware.

8. The utility will prompt for the ALC firmware file which was unzipped in the steps above. Select this file and allow the utility to complete the update process.

A.7 ASSEMBLIES THAT REQUIRE PHYSICAL REPLACEMENT TO UPDATE FIRMWARE

The following assemblies can only have their firmware updated by swapping physical assemblies:

- BB - Bias Board Assembly (x4) - *Found in the MPA's*

WARRANTIES: LIMITATION OF LIABILITY

Seller warrants (i) that seller has title to the goods sold and (ii) that Amplifiers (all parts excluding traveling wave and vacuum tubes), Antennas, field monitors, field probes, field analyzers, field analyzer processor units, system controllers, system interlock, power meters, leak detectors, RF conducted probes, RF conducted clamps, Multi-tone, EMI receiver systems, RF down converters, RF conducted immunity systems, conducted immunity accessories, radiated immunity test systems, safety meters, safety sensor heads, tripods, directional couplers, waveguide adapters, termination loads, load attenuators, impedance stabilization networks, and coaxial cables will be free from defects in material and workmanship for a period of three (3) years from date of shipment shown on AR RF/Microwave Instrumentation invoice.

All modules, used in the amplifiers for the 1-6 GHz, 4-18 GHz, 6-18 GHz, all HPM products, and other applications, are hermetically-sealed. This sealing process protects the internal hybrid circuitry from humidity that could compromise the long term reliability of the product. These modules are not field-repairable and should *never* be opened outside of AR's Microelectronics Lab. The modules in these product lines have a security label on two sides of the modules between the housing and lid/cover. If the security label is removed and or cut, the warranty of the module will be voided.

Vacuum tubes in the 'L' series amplifiers, traveling-wave tubes in TWT amplifiers, and power heads will be free from defects in material and workmanship for a period of one (1) year.

Contact AR RF/Microwave Instrumentation for warranty information regarding items not listed.

Seller's sole responsibility in fulfilling these warranties shall be to repair or replace any goods which do not conform to the foregoing warranties or, at seller's option, to give buyer credit for defective goods. The warranty is valid only when used in the country specified at time of order. Warranty service must be obtained from the repair facility designated at that time. If warranty service is not available in the country where the equipment is to be used, it must be returned to AR RF/Microwave Instrumentation. Warranty service will be provided only for defective goods which are returned within the warranty period, freight costs prepaid to AR RF/Microwave Instrumentation or its designated repair facility.

There are no other warranties, express or implied, including any warranty of merchantability or fitness. Seller shall not be responsible for any incidental or consequential damages arising from any breach of warranty.

No person other than an officer of Amplifier Research Corporation, has any authority to bind seller to any affirmation, representation or warranty except as specifically included in the preceding terms and conditions.

